

VENTA®
BY BÜCHER DESIGN

02.08.2023

"We have invested all of our energy into making our furniture as functional as possible, but with such elegant designs that this is not immediately obvious."
Karl Büchin, General Manager Büchin Design, Berlin



Büchin Design develops, builds and sells individual furniture for the hotel industry and events catering business under the brand name „VENTA by Büchin Design“.

The high-quality buffet furniture includes exclusive cocktail tables and stylish buffet tables as well as matching modern stools. Most VENTA furnishings can be folded up or stacked together to save space, and can be assembled and disassembled in just a few easy steps, without the need for any tools.

All of our buffet furniture is mobile and can be used anywhere. It meets the high demands of the hotel, events and catering industry in every respect.

Our VENTA products have an exclusive design and are available worldwide.

Most of our VENTA products are manufactured in Germany, and we are pleased to appear with the “Made in Germany” seal at trade fairs both in Germany and abroad.



Capsicum
Boursin Bites

00 Lookbook
Impressions



page 4

01 Buffet Tables
(on castors)



page 20

02 System with two Table
Tops (on castors)



page 38

03 Action Stations
(on castors)



page 46

04 Buffet
Accessories



page 98

05 Special Buffet
Furniture



page 153

06 Foldable Buffet
Tables



page 162

07 Cocktail Tables
+ Bar Area



page 172

08 Coffee Station,
Cupboard, Rack



page 210

09 Equipment
for all Furniture



page 220

Material +
Color



page 236

References
Worldwide



page 256











Spicy Pumpkin
Sunflower Seeds

Half Grain Buns
Avocado Egg

Spicy
Balls

Spicy
Balls



My Food Favorites
Healthy Choices





VEGETABLE FARM
PREPARED FOR SERVICE BY
ALL INFORMATION

SOUP OF THE DAY
PLEASE ASK TO MEMBER OF STAFF FOR
ALL INFORMATION









table-top: compact panel
decor: Dark Grey Chicago Concrete (415)



STAGE_80_M | breakfast station





Buffet Tables on castors

STAGE_80 | STAGE_50



all tables nested and
adjusted at the lowest
height

Item No.: 81001100402
L: 1960 x 800 x 935 mm
M: 1800 x 800 x 855 mm
2 x XS: 800 x 800 x 775 mm
total weight: 119,8 kg

STAGE – the modular buffet system

modern look & easy to move
simple, functional, good-looking.

The modular buffet table system STAGE_80 can be assembled and disassembled in just a few easy steps, without the need for any tools.

The trolley system allows you to storage all four tables in a mobile wooden box on wheels.

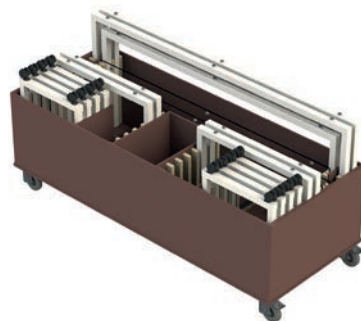

explosion view/
main parts



Item No.: 99106
Trolley/STAGE-System
dimensions: 205 x 87 cm

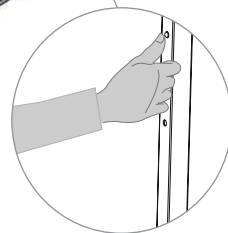

total buffet length: 536 cm

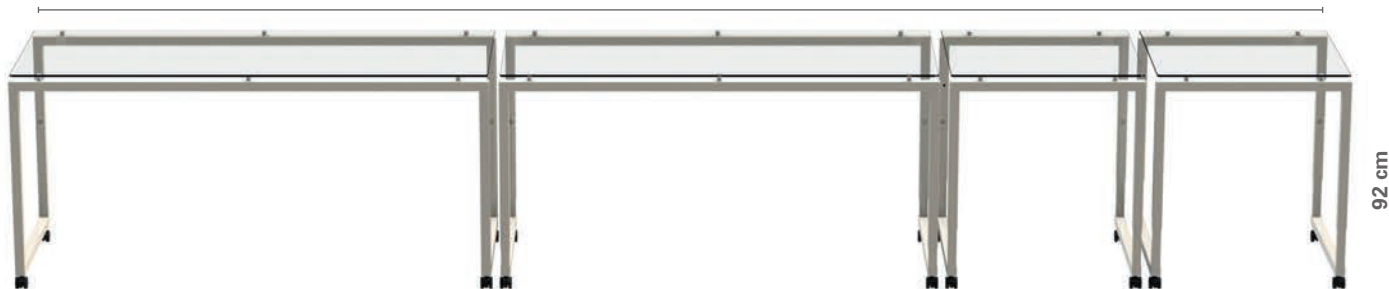

all tables in a row/adjusted at the same height

Features

SYSTEM SIZE – table system available in three standard lengths (L=196 cm, M=180 cm, 2 x XS=80 cm).

NESTING – the three standard sizes can be pushed together, so that only 1,96 m of the 5,36 m buffet table length is required as NESTING system.

COMBINE – system available in two table depths, 80 cm = classic buffet size/50 cm = table depth for smaller meeting rooms. Combinations of the two table depths result in interesting buffet variants or e.g. a MOBILE BAR.

ADAPTIVE – each table can be optimised for the respective area of use with additional equipment (e.g. shelves below the table surface for use as a plate shelf).

CHANGEABLE – a light, elegant buffet system consisting only a metal frame for the table legs and a transparent glass top. Or a buffet system with full equipment including appliances for heating and cooling, thermal bridges, shelves and blinds – STAGE can do both.

FUNCTIONAL – wheel diameter in three sizes suitable for the application: small = in the room or on the floor/medium = in the whole hotel, also suitable for lifts or smaller thresholds/large = inhouse and outdoor, also usable on the terrace.

ADJUSTABLE HEIGHT – four table heights can be adjusted at each table in a grid of 8 cm, thus enabling an interesting and varied furniture construction.

MOBILE – buffet table on wheels, which can be moved in any room and throughout the hotel, all wheels are lockable to fix the table in place.

STORAGE – if required, the system can be dismantled without tools and stowed in trolleys (wooden boxes on wheels), each part has a fixed place due to a grid system and cannot be damaged during transport.

COLOR – elegant lacquering of the table frames and the table tops (underside of the glass tops), so the matching color to the room concept is selectable.

DECOR – table tops available in „compact top“ material with various decorative surfaces (photo reproduction: wood, stone, metal).

BLINDS – various decor panels to choose from, variants from completely closed to translucent, can be quickly assembled and disassembled by magnet attachment, enables „invisible supply“.

Three castor sizes for STAGE buffet tables – generally recommended for indoor use.

Ø = 50 mm/suitable for using on all grounds, but at the same level.

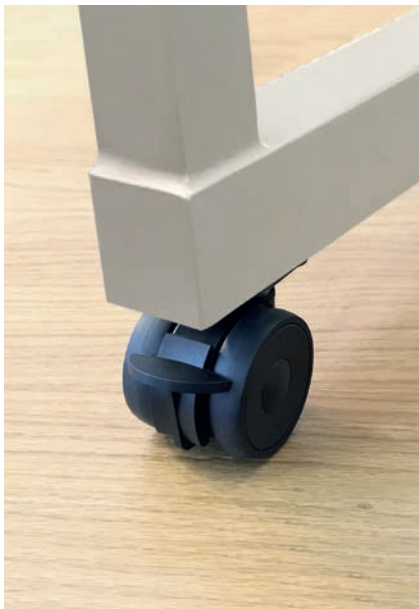

Ø = 65 mm/standard size suitable for using an elevator (to cross the gap), for longer distance and high pile carpet.



Ø = 75 mm/suitable for using anywhere, especially for catering purposes.



Castor sizes – influence the height of the tables | all sizes useable for buffet purpose

table height: 92,0 cm
Ø = 50 mm

table height: 93,5 cm
Ø = 65 mm

table height: 94,5 cm
Ø = 75 mm

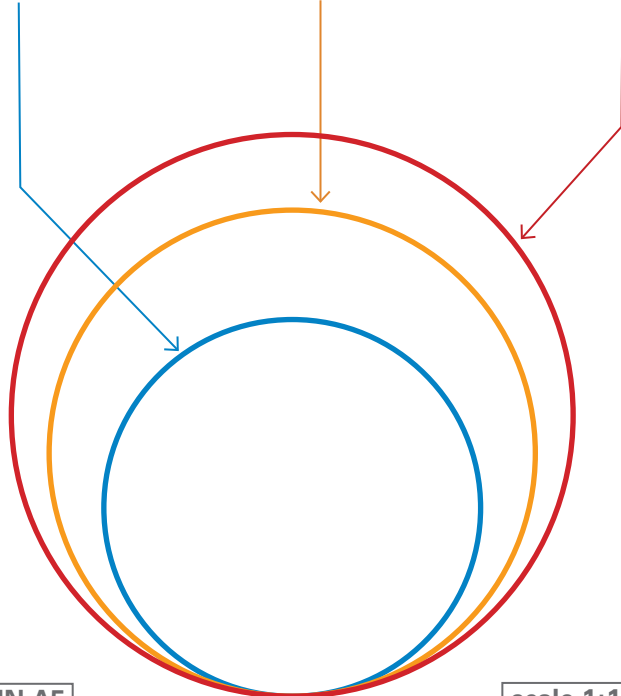

DIN A5

scale 1:1

standard size / Ø = 65 mm



STAGE_80 | set of 4 tables

Item No.: 81001100402

L: 1960 x 800 x 935 mm
M: 1800 x 800 x 855 mm
2 x XS: 800 x 800 x 775 mm
total weight: 119,8 kg

Base (inkl. castors)

steel, powder-coated anthracite
profile 40 x 40 mm, with height
compensation
weight: 18,3 kg, 17,3 kg, 2 x 13,3 kg

Table-top

compact laminate 10 mm,
ceramic anthracite (402)
weight: 21 kg, 19 kg, 2 x 8,8 kg

Height adjustable-system

L: 935, 1015, 1095, 1175 mm
M: 855, 935, 1015, 1095 mm
XS: 775, 855, 935, 1015 mm

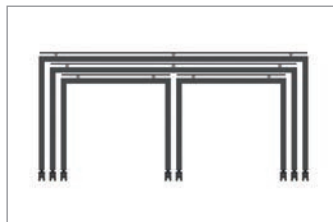

connection between table-top and base

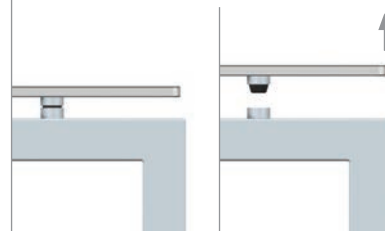

height can
be adjusted
(77,5-117,5 cm)



arrangement of the four buffet tables



MATERIAL+COLOR

basic
base: 100, 101
table-top: 300, 401, 402

option
all available colors in chapter
MATERIAL+COLOR

Item No.: 99106

Trolley for 1 x STAGE_80 (set of 4 tables)



weight: 75 kg [empty] / 194,8 kg [full]

STAGE_80 | set of 3 tables

Item No.: 81094100300

L: 1960 x 800 x 935 mm
M: 1800 x 800 x 855 mm
S_164: 1640 x 800 x 775 mm
total weight: 155,3 kg

Base

steel, powder-coated anthracite
profile 40 x 40 mm, with height
compensation
weight: 18,3 kg, 17,3 kg, 15,7 kg

Table-top

safety glass 10 mm,
weight: 38 kg, 35 kg, 31 kg

Height adjustable-system

L: 935, 1015, 1095, 1175 mm
M: 855, 935, 1015, 1095 mm
S_164: 775, 855, 935, 1015 mm

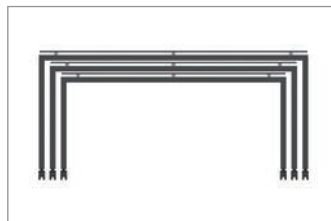

height can
be adjusted
(77,5-117,5 cm)



table on castors →

MATERIAL+COLOR

basic

base: 100, 101
table-top: 300, 401, 402

option

all available colors in chapter
MATERIAL+COLOR

connection between table-top and base

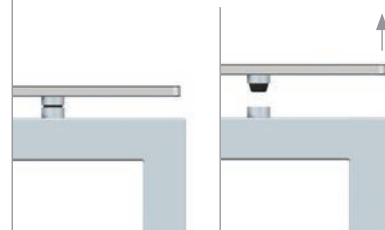

Item No.: 99106

Trolley for 1 x STAGE_80 (set of 3 tables)



weight: 75 kg [empty] / 230,3 kg [full]

STAGE_80_L

Item No.: 81002100402

[LxWxH]: 1960 x 800 x 935 mm
total weight: 39,3 kg

Base

2 x main frame 11,6 kg
2 x table leg 6,2 kg
steel, powder-coated anthracite (100)
profile 40 x 40 mm, with height
compensation

height can
be adjusted
(93,5-117,5 cm)



MATERIAL+COLOR

basic

base: 100, 101
table-top: 300, 401, 402

option

all available colors in chapter
MATERIAL+COLOR

4 x Castor

diameter = 65 mm
weight: 0,5 kg

Height adjustable:

935 mm (lowest height)
1015, 1095, 1175 mm

Table-top

compact laminate 10 mm,
ceramic anthracite (402)
weight: 21 kg

Alternative:

Table-top

safety glass 10 mm,
transparent (300),
white colored (303)
weight: 38 kg

assembly of individual parts without tools

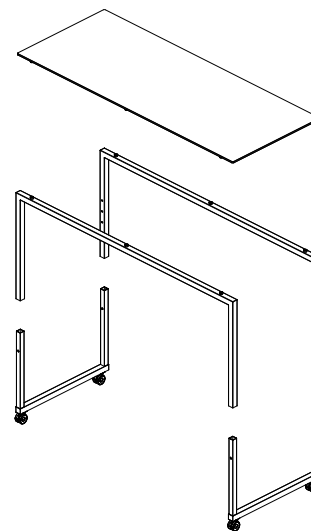

Item No.: 99107

Trolley for 4 x STAGE_80_L (maximum load)



weight: 75 kg [empty] / 232,2 kg [full]

STAGE_80_M

Item No.: 81003100402

[LxWxH]: 1800 x 800 x 855 mm
total weight: 35,8 kg

Base

2 x main frame 10,6 kg
2 x table leg 6,2 kg
steel, powder-coated anthracite (100)
profile 40 x 40 mm, with height
compensation

height can
be adjusted
(85,5-109,5 cm)



MATERIAL+COLOR

basic

base: 100, 101
table-top: 300, 401, 402

option

all available colors in chapter
MATERIAL+COLOR

4 x Castor

diameter = 65 mm
weight: 0,5 kg

Height adjustable:

855 mm (lowest height)
935, 1015, 1095 mm

Table-top

compact laminate 10 mm,
ceramic anthracite (402)
weight: 19 kg

Alternative:

Table-top

safety glass 10 mm,
transparent (300),
white colored (303)
weight: 35 kg

assembly of individual parts without tools

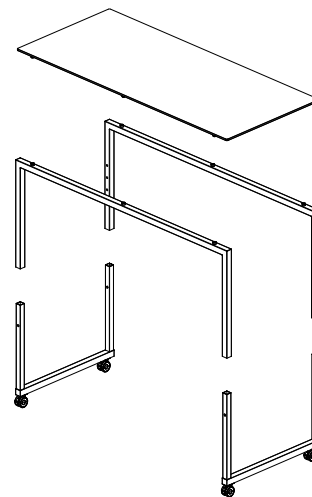

Item No.: 99109

Trolley for 4 x STAGE_80_M (maximum load)



weight: 75 kg [empty] / 218,2 kg [full]

STAGE_80_S_164

Item No.: 81056100402

[LxWxH]: 1640 x 800 x 775 mm
total weight: 39,3 kg

Base

2 x main frame 11,6 kg
2 x table leg 6,2 kg
steel, powder-coated anthracite (100)
profile 40 x 40 mm, with height
compensation

height can
be adjusted
(77,5-101,5 cm)



MATERIAL+COLOR

basic

base: 100, 101
table-top: 300, 401, 402

option

all available colors in chapter
MATERIAL+COLOR

4 x Castor

diameter = 65 mm
weight: 0,5 kg

Height adjustable:

755 mm (lowest height)
855, 935, 1015 mm

Table-top

compact laminate 10 mm,
ceramic anthracite (402)
weight: 21 kg

Alternative:

Table-top

safety glass 10 mm,
transparent (300),
white colored (303)
weight: 38 kg

assembly of individual parts without tools

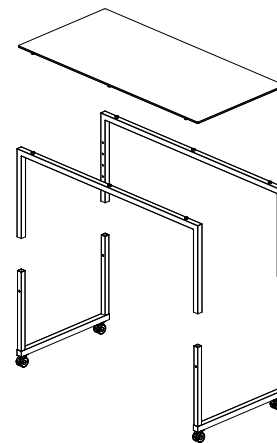

Item No.: 99123

Trolley for 4 x STAGE_80_S_164 (maximum load)



weight: 72 kg [empty] / 229,2 kg [full]

STAGE_80_XS

Item No.: 81003100402

[LxWxH]: 800 x 800 x 775 mm
total weight: 35,8 kg

Base

2 x main frame 10,6 kg
2 x table leg 6,2 kg
steel, powder-coated anthracite (100)
profile 40 x 40 mm, with height
compensation

height can
be adjusted
(77,5-101,5 cm)

**4 x Castor**

diameter = 65 mm
weight: 0,5 kg

Height adjustable:

775 mm (lowest height)
855, 935, 1015 mm

Table-top (VE-14016)

compact laminate 10 mm,
ceramic anthracite (402)
weight: 19 kg

**MATERIAL+COLOR****basic**

base: 100, 101
table-top: 300, 401, 402

option

all available colors in chapter
MATERIAL+COLOR

Alternative:**Table-top**

safety glass 10 mm,
transparent (300),
white colored (303)
weight: 35 kg

assembly of individual parts without tools

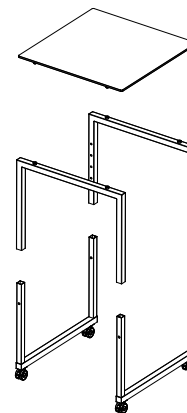
**Item No.:** 99114

Trolley for 4 x STAGE_80_XS (maximum load)



weight: 48 kg [empty] / 191,2 kg [full]

STAGE_50 | set of 4 tables

Item No.: 51001100402

L: 1960 x 500 x 935 mm
M: 1800 x 500 x 855 mm
2 x XS: 800 x 500 x 775 mm
total weight: 98,0 kg

Base (inkl. castors)

steel, powder-coated anthracite
profile 40 x 40 mm, with height
compensation

Table-top

compact laminate 10 mm,
ceramic anthracite (402)

Height adjustable-system

L: 935, 1015, 1095, 1175 mm
M: 855, 935, 1015, 1095 mm
XS: 775, 855, 935, 1015 mm

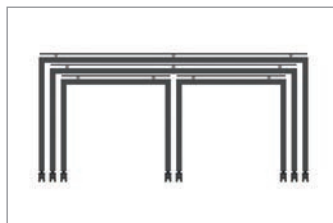

connection between table-top and base

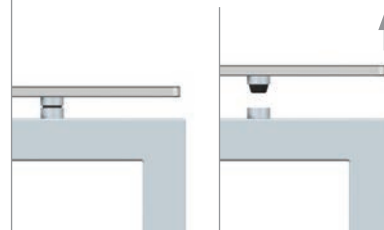

height can
be adjusted
(77,5-117,5 cm)



arrangement of the four buffet tables



MATERIAL+COLOR

basic
base: 100, 101
table-top: 300, 401, 402

option
all available colors in chapter
MATERIAL+COLOR

Item No.: 99106

Trolley for 1 x STAGE_50 (set of 4 tables)



weight: 75 kg [empty] / 173,0 kg [full]

STAGE_50 | set of 3 tables

Item No.: 51050100300

L: 1960 x 500 x 935 mm
M: 1800 x 500 x 855 mm
S_164: 1640 x 500 x 775 mm
total weight: 87,0 kg

Base

steel, powder-coated anthracite
profile 40 x 40 mm, with height
compensation

Table-top

compact laminate 10 mm

Height adjustable-system

L: 935, 1015, 1095, 1175 mm
M: 855, 935, 1015, 1095 mm
S_164: 775, 855, 935, 1015 mm

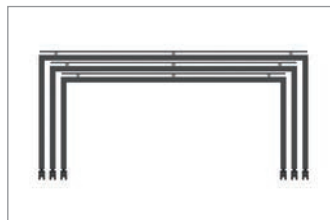

height can
be adjusted
(77,5-117,5 cm)



MATERIAL+COLOR

basic

base: 100, 101
table-top: 300, 401, 402

option

all available colors in chapter
MATERIAL+COLOR

connection between table-top and base

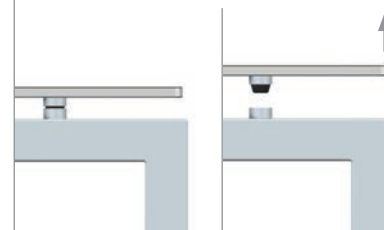

Item No.: 99106

Trolley for 1 x STAGE_50 (set of 3 tables)



weight: 75 kg [empty] / 162,0 kg [full]

STAGE_50_L

Item No.: 51002100402

[LxWxH]: 1960 x 500 x 935 mm
total weight: 32,1 kg

Base

2 x main frame 11,6 kg
2 x table leg 5,0 kg
steel, powder-coated anthracite (100)
profile 40 x 40 mm, with height
compensation

height can
be adjusted
(93,5-117,5 cm)

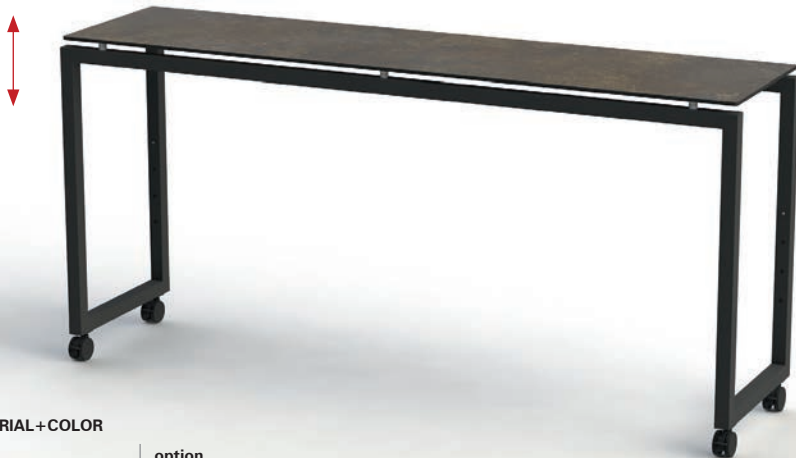

MATERIAL+COLOR

basic

base: 100, 101
table-top: 300, 401, 402

option

all available colors in chapter
MATERIAL+COLOR

4 x Castor

diameter = 65 mm
weight: 0,5 kg

Height adjustable:

935 mm (lowest height)
1015, 1095, 1175 mm

Table-top

compact laminate 10 mm,
ceramic anthracite (402)
weight: 15,0 kg

Alternative:

Table-top

safety glass 10 mm,
transparent (300),
white colored (303)
weight: 24,0 kg

assembly of individual parts without tools

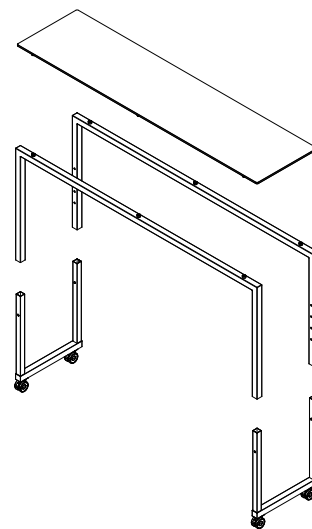

Item No.: 99109

Trolley for 4 x STAGE_50_L (maximum load)



weight: 75 kg [empty] / 203,4 kg [full]

STAGE_50_M

Item No.: 51003100402

[LxWxH]: 1800 x 500 x 855 mm
total weight: 29,1 kg

Base

2 x main frame 10,6 kg
2 x table leg 5,0 kg
steel, powder-coated anthracite (100)
profile 40 x 40 mm, with height
compensation

height can
be adjusted
(85,5-109,5 cm)



MATERIAL+COLOR

basic

base: 100, 101
table-top: 300, 401, 402

option

all available colors in chapter
MATERIAL+COLOR

4 x Castor

diameter = 65 mm
weight: 0,5 kg

Height adjustable:

855 mm (lowest height)
935, 1015, 1095 mm

Table-top

compact laminate 10 mm,
ceramic anthracite (402)
weight: 13,0 kg

Alternative:

Table-top

safety glass 10 mm,
transparent (300),
white colored (303)
weight: 22,0 kg

assembly of individual parts without tools

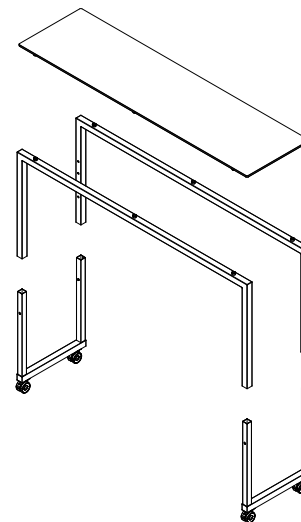

Item No.: 99109

Trolley for 4 x STAGE_80_M (maximum load)



weight: 75 kg [empty] / 191,4 kg [full]

STAGE_50_S_164

Item No.: 51017100402

[LxWxH]: 1640 x 500 x 775 mm
total weight: 26,5 kg

Base

2 x main frame 9,0 kg
2 x table leg 5,0 kg
steel, powder-coated anthracite (100)
profile 40 x 40 mm, with height
compensation

4 x Castor

diameter = 65 mm
weight: 0,5 kg

Height adjustable:

775 mm (lowest height)
855, 935, 1015 mm

Table-top

compact laminate 10 mm,
ceramic anthracite (402)
weight: 12,0 kg

Alternative:

Table-top

safety glass 10 mm,
transparent (300),
white colored (303)
weight: 20,0 kg

height can
be adjusted
(77,5-101,5 cm)



MATERIAL+COLOR

basic

base: 100, 101
table-top: 300, 401, 402

option

all available colors in chapter
MATERIAL+COLOR

assembly of individual parts without tools

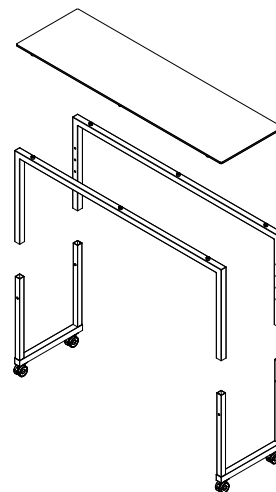

Item No.: 99123

Trolley for 4 x STAGE_50_S_164 (maximum load)



weight: 72 kg [empty] / 178,0 kg [full]

STAGE_50_XS

Item No.: 51004100402

[LxWxH]: 800 x 500 x 775 mm
total weight: 20,9 kg

Base

2 x main frame 6,6 kg
2 x table leg 5,0 kg
steel, powder-coated anthracite (100)
profile 40 x 40 mm, with height
compensation

height can
be adjusted
(77,5-101,5 cm)



MATERIAL+COLOR

basic

base: 100,101
table-top: 300, 401, 402

option

all available colors in chapter
MATERIAL+COLOR

4 x Castor

diameter = 65 mm
weight: 0,5 kg

Height adjustable:

775 mm (lowest height)
855, 935, 1015 mm

Table-top

compact laminate 10 mm,
ceramic anthracite (402)
weight: 8,8 kg

Alternative:

Table-top

safety glass 10 mm,
transparent (300),
white colored (303)
weight: 9,5 kg

assembly of individual parts without tools

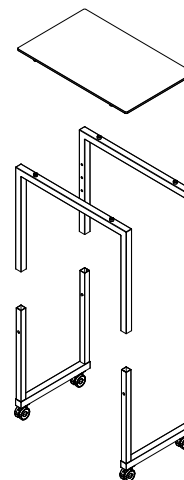

Item No.: 99114

Trolley for 4 x STAGE_50_XS (maximum load)



weight: 48 kg [empty] / 131,6 kg [full]

System with two Table-Tops

STAGE_80_S table | STAGE_50_S_table



STAGE_80_S | system with two separate table-tops

Item No.: 81039100

[LxWxH]: 1600 x 800 x 775 mm
total weight: 15,2 kg

Base

2 x main frame 9,0 kg
2 x table leg 6,2 kg
steel, powder-coated anthracite (100)
profile 40 x 40 mm, with height compensation

4 x Castor

diameter = 65 mm
weight: 0,5 kg

Height adjustable:

775 mm (lowest height)
855, 935, 1015 mm

Table-top

compact laminate 10 mm,
ceramic anthracite (402)
weight: 8,8 kg

Alternative:

Table-top

safety glass 10 mm,
transparent (300),
white colored (303)
weight: 15,0 kg

base_STAGE_80_S / Item No.: 81039100



table-top XS / Item No.: 14018402



explosion view



height can
be adjusted
(77,5-101,5 cm)



MATERIAL+COLOR

basic

base: 100, 101
table-top: 300, 401, 402

option

all available colors in chapter
MATERIAL+COLOR

**order separately:
base and table-top**

STAGE_80_S | system with two separate table-tops

HEATBRIDGE_BEER_SOLARIS_80_DS
Item No.: 66014101

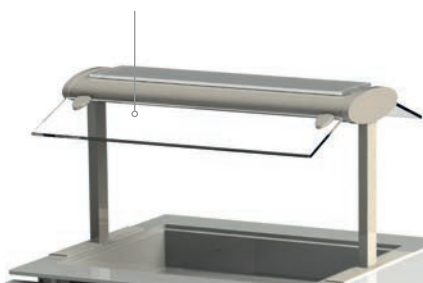

>>> create two different functions on the same table base

table-top_STAGE_80_XS
Item No.: 13006303

table-top-unit_STAGE_80_XS_BAIN-MARIE_COOL+HOT
Item No.: 11028101414

table base STAGE_80_S
Item No.: 80039101

Item No.: 99122

Trolley for 6 x STAGE_80_S base frames or 6 x STAGE_50_S base frames (maximum load)

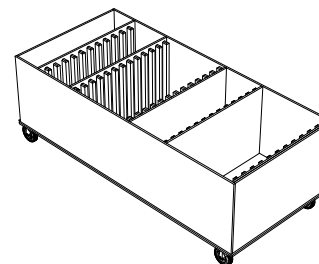

weight: 48 kg [empty] / 131,6 kg [full]

Item No.: 99159

Trolley for 3 x table-top-unit_STAGE_80_XS (maximum load)

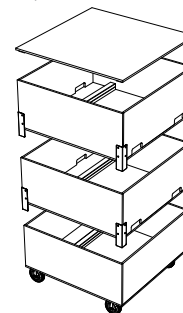

weight: 51 kg [empty]

STAGE_80_S | available table-top units

table-top_STAGE_80_XS
Item No.: 13006300
table-top / glass, transparent (300)



table-top_STAGE_80_XS
Item No.: 14018402
table-top / compact panel, ceramic anthracite (402)



table-top-unit_STAGE_80_XS_COOL
Item No.: 11010100307
metal bowl / steel, anthracite (100)
table-top / glass, black colored (307)

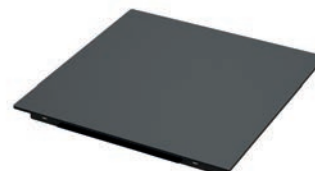

> more details see in chapter COOL

table-top-unit_STAGE_80_XS_ICE_WELL
Item No.: 11084100402
metal housing / steel, anthracite (100)
table-top / compact panel, ceramic anthracite (402)



> more details see in chapter COOL

table-top-unit_STAGE_80_XS_C+H
Item No.: 11014402307100
table-top / compact panel, ceramic anthracite (402)
device-top: glass, black colored (307)
metal parts: steel, anthracite (100)



> more details see in chapter COOL

table-top-unit_STAGE_80_XS_BAIN-MARIE_C+H
Item No.: 11028100402
metal housing / steel, anthracite (100)
table-top / compact panel, ceramic anthracite (402)



> more details see in chapter COOL

STAGE_80_S | available table-top units

table-top_unit_STAGE_80_XS_INDUCTION_VARIO_2
Item No.: 11164100402
metal parts: steel, anthracite (100)
table-top / compact panel, ceramic anthracite (402)

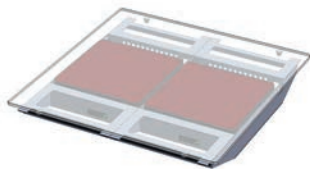

> more details see page INDUCTION_VARIO

table-top_unit_STAGE_80_XS_INDUCTION_VARIO_1
Item No.: 11165100402
metal parts: steel, anthracite (100)
table-top / compact panel, ceramic anthracite (402)

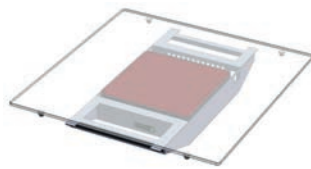

> more details see page INDUCTION_VARIO

table-frame_STAGE_80_ELEMENTS
Item No.: 20007199
metal frame / stainless steel (199)

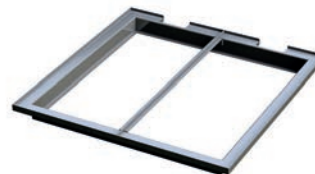

> more details see chapter Modular Cooking System

table-top-unit_STAGE_80_XS_CHAFING-DISH_1
Item No.: 11057402
table-top / compact panel, ceramic anthracite (402)



> more details see chapter CHAFING-DISH

table-top-unit_STAGE_80_XS_CHAFING-DISH_2
Item No.: 11054402
table-top / compact panel, ceramic anthracite (402)



> more details see chapter CHAFING-DISH

STAGE_50_S | table system + available table-top units

Item No.: 51019100

[LxWxH]: 1600 x 500 x 775 mm
total weight: 15,0 kg

Base

2 x main frame 9,0 kg
2 x table leg 6,0 kg
steel, powder-coated anthracite (100)
profile 40 x 40 mm, with height compensation

4 x Castor

diameter = 65 mm
weight: 0,5 kg

Height adjustable:

775 mm (lowest height)
855, 935, 1015 mm

Table-top

compact laminate 10 mm,
ceramic anthracite (402)
weight: 5,6 kg

Alternative:

Table-top

safety glass 10 mm,
transparent (300),
white colored (303)
weight: 9,5 kg

table-top_STAGE_50_XS

Item No.: 13029300

table-top / glass, transparent (300)



table-top_STAGE_50_XS

Item No.: 14023402

table-top / compact panel, ceramic anthracite (402)



table-top-unit_STAGE_50_XS_COOL

Item No.: 11041307100

table-top / glass, black colored (307)
metal bowl / steel, anthracite (100)



height can
be adjusted
(77,5-101,5 cm)

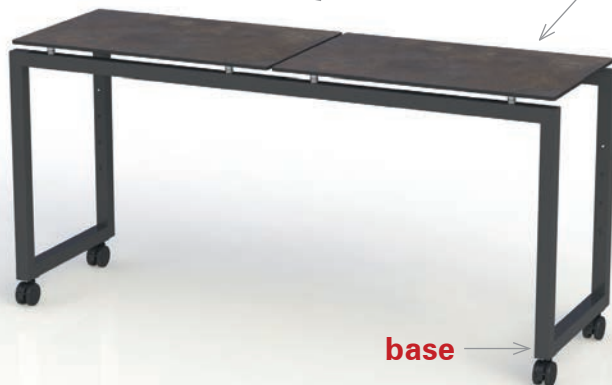

order separately:
table-top

base

MATERIAL+COLOR

basic

base: 100, 101
table-top: 300, 401, 402

option

all available colors in chapter
MATERIAL+COLOR

STAGE_50_S | available table-top units

table-top-unit_STAGE_50_XS_BAIN-MARIE_C+H
Item No.: 11029100402
metal housing / steel, anthracite (100)
table-top / compact panel, ceramic anthracite (402)



> more details see in chapter COOL

table-top-unit_STAGE_50_XS_ICE_WELL
Item No.: 11085100402
metal housing / steel, anthracite (100)
table-top / compact panel, ceramic anthracite (402)



> more details see in chapter COOL

table-top-unit_STAGE_50_XS_CHAFING-DISH_1
Item No.: 11055402
table-top / compact panel, ceramic anthracite (402)



> more details see chapter CHAFING-DISH

COOL+HOT_ELEMENTS
Item No.: 20011199303
housing: stainless steel
glass top: white colored glass (303)

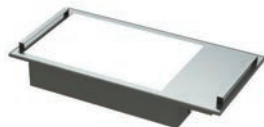

> more details see chapter Modular Cooking System

table-frame_COMPACT_STAGE_50_ELEMENTS
Item No.: 20020199402
metal frame / stainless steel (199)
table-top / compact panel, ceramic anthracite (402)



> more details see chapter Modular Cooking System

Action Stations

Warm Buffet | Cold Buffet | Modular Cooking and Buffet System



INDUCTION_VARIO

flexible induction system | suitable for every STAGE table



STAGE_80_L_INDUCTION_VARIO_3
Item No.: 81096

**Place three 1/1 GN Chafing-Dishes in a row.
table length = 196 cm**

Free positioning of induction units

The new induction system VARIO for flexible and variable use of induction heat wherever you need it.

The system is available as single components or in a complete table.

A single metal housing with an induction unit inside can be placed under any STAGE_80 table (table-top). Depending on the length of the table, you can flexibly determine the position of the unit and the distance to the next unit.

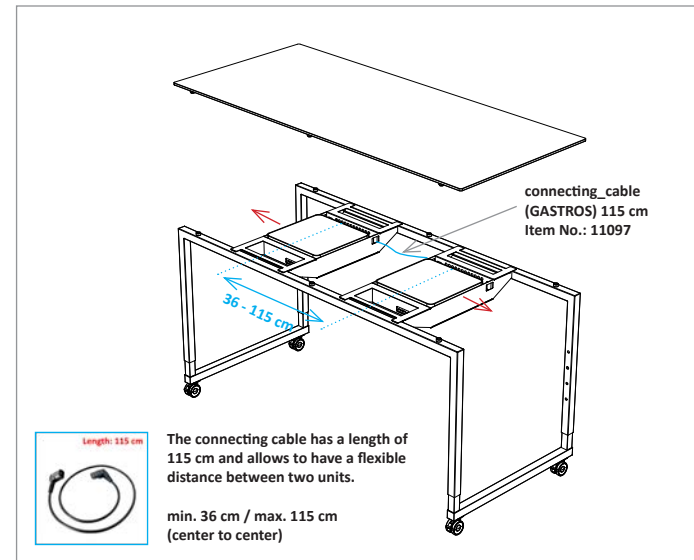
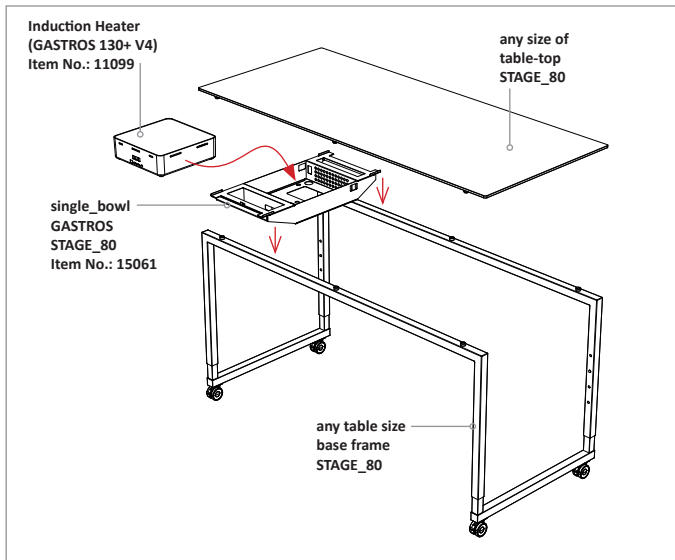

Multizone induction | field size 35 x 35 cm

There is no surface marking on the table top. You can determine the central position above the induction unit using the position markings on the metal housing.

The area around the central position is 350 x 350 mm and also allows you to place several pots above each induction (multi-zone unit).

To protect the table surface from overheating, please use the silicone mats.

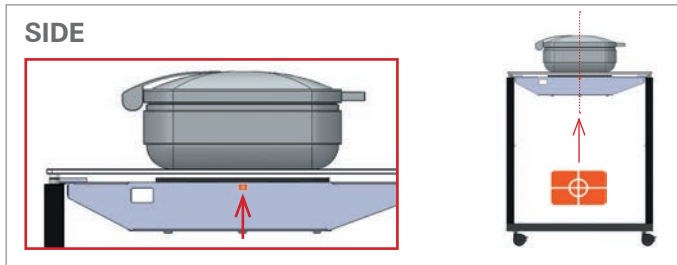
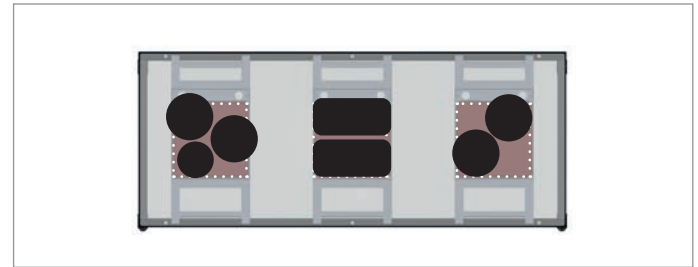
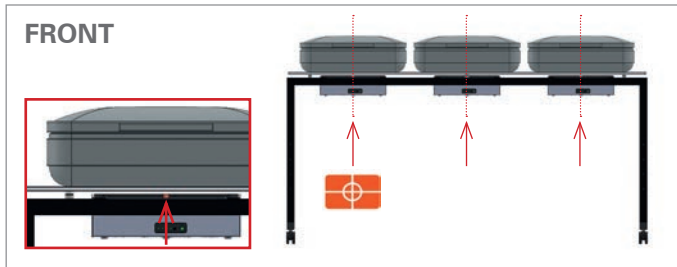

STAGE_80_L_INDUCTION_VARIO_4
Item No.: 81095



STAGE_80_L_INDUCTION_VARIO_3
Item No.: 81096



Table Size L (1960 x 800 x 935 mm)
table heights = 935, 1015, 1095, 1175 mm

STAGE_80_L_INDUCTION_VARIO_2
Item No.: 81097



STAGE_80_L_INDUCTION_VARIO_1
Item No.: 81098



STAGE_80_M_INDUCTION_VARIO_4
Item No.: 81099



STAGE_80_M_INDUCTION_VARIO_3
Item No.: 81100



Table Size M (1800 x 800 x 935 mm)
table heights = 855, 935, 1015, 1095 mm

STAGE_80_M_INDUCTION_VARIO_2
Item No.: 81101



STAGE_80_M_INDUCTION_VARIO_1
Item No.: 81102



STAGE_80_S_164_INDUCTION_VARIO_4
Item No.: 81103



STAGE_80_S_164_INDUCTION_VARIO_3
Item No.: 81104



Table Size S_164 (1640 x 800 x 935 mm)
table heights = 775, 855, 935, 1015 mm

STAGE_80_S_164_INDUCTION_VARIO_2
Item No.: 81105



STAGE_80_S_164_INDUCTION_VARIO_1
Item No.: 81106



STAGE_80_XS_INDUCTION_VARIO_2
Item No.: 81107



STAGE_80_XS_INDUCTION_VARIO_1
Item No.: 81108



Table Size XS (800 x 800 x 935 mm)
table heights = 775, 855, 935, 1015 mm

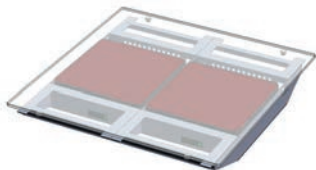

>>> suitable for **STAGE_80_XS** and **S**
table-top_unit_STAGE_80_XS_INDUCTION_VARIO_2
Item No.: 11164

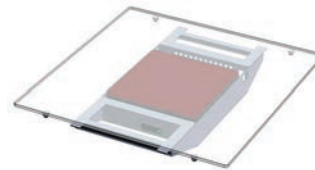

>>> suitable for **STAGE_80_XS** and **S**
table-top_unit_STAGE_80_XS_INDUCTION_VARIO_1
Item No.: 11165

Chafing-Dish

electrical heated chafing-dish integrated in a STAGE table



NEW
table with
integrated
CHAFFINIG
DASH
VENTA

STAGE_80_M_CHAFING-DISH_4

Item No.: 81078100402

[LxWxH]: 1800 x 800 x 855 mm
weight: 56,3 kg

Base

2 x main frame 10,6 kg
2 x table leg 6,2 kg
steel, powder-coated anthracite (100)
profile 40 x 40 mm, with height
compensation

4 x Castor

diameter = 65 mm
weight: 0,5 kg

Height adjustable:

855 mm (lowest height)
935, 1015, 1095 mm

Table-Top

compact panel, 10 mm,
decor: ceramic anthracite
weight: 36,3 kg

2 x Magnetic cable duct

[LxWxH]: 770 x 35 x 21 mm
weight: 0,965 kg
steel, 1 mm, bended, powder-coated
anthracite

4 x Magnetic holder

[LxWxH]: 173 x 66 x 23 mm
weight: 0,186 kg
steel, 1 mm, bended, powder-coated
anthracite

combination of STAGE_80_M_CHAFING-DISH_4
and STAGE_80_XS_CHAFING-DISH_2 + BLINDS



delivery content:

including 4 x inlay panel to
close the openings, without
chafing-dish

perfect system
to present warm food in
integrated chafing-dish



top view



Item No.: 99144

Trolley for max. 2 x table 80_M_CHAFING-DISH



weight: 65 kg [empty] / 154 kg [full]

MATERIAL+COLOR

basic

base: 100, 101
table-top: 401, 402

option

all available colors in chapter
MATERIAL+COLOR

STAGE_80_XS_CHAFING-DISH_2

Item No.: 81080100402

[LxWxH]: 800 x 800 x 775 mm
weight: 33,6 kg

Base

2 x main frame 6,6 kg
2 x table leg 6,2 kg
steel, powder-coated anthracite (100)
profile 40 x 40 mm, with height
compensation

4 x Castor

diameter = 65 mm
weight: 0,5 kg

Height adjustable:

775 mm (lowest height)
855, 935, 1015 mm

Table-Top

compact panel, 10 mm,
decor: ceramic anthracite
weight: 18,0 kg

1 x Magnetic cable duct

[LxWxH]: 770 x 35 x 21 mm
weight: 0,965 kg
steel, 1 mm, bended, powder-coated
anthracite

2 x Magnetic holder

[LxWxH]: 173 x 66 x 23 mm
weight: 0,186 kg
steel, 1 mm, bended, powder-coated
anthracite

delivery content:

including 2 x inlay panel to
close the openings, without
chafing-dish



MATERIAL+COLOR

basic

base: 100,101
table-top: 401, 402

option

all available colors in chapter
MATERIAL+COLOR

system suitable for
chafing-dish units
by WMF

combination of STAGE_80_M_CHAFING-DISH_4
and STAGE_80_XS_CHAFING-DISH_2



top view



Item No.: 99145

trolley for max. 2 x table 80_XS_CHAFING-DISH

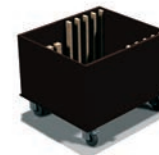

weight: 50 kg [empty] / 104 kg [full]

STAGE_80_M_CHAFING-DISH_3

Item No.: 81079100402

[LxWxH]: 1800 x 800 x 855 mm
weight: 56,1 kg

Base

2 x main frame 10,6 kg
2 x table leg 6,2 kg
steel, powder-coated anthracite (100)
profile 40 x 40 mm, with height
compensation

delivery content:

including 3 x inlay panel to
close the openings, without
chafing-dish

4 x Castor

diameter = 65 mm
weight: 0,5 kg

Height adjustable:

855 mm (lowest height)
935, 1015, 1095 mm

Table-Top

compact panel, 10 mm,
decor: ceramic anthracite
weight: 36,3 kg

2 x Magnetic cable duct

[LxWxH]: 770 x 35 x 21 mm
weight: 0,965 kg
steel, 1 mm, bended, powder-coated
anthracite

3 x Magnetic holder

[LxWxH]: 173 x 66 x 23 mm
weight: 0,186 kg
steel, 1 mm, bended, powder-coated
anthracite

perfect system
to present warm food in
integrated chafing-dish



MATERIAL+COLOR

basic

base: 100, 101
table-top: 401, 402

option

all available colors in chapter
MATERIAL+COLOR

STAGE_80_M_CHAFING-DISH_3 + BLINDS



top view



Item No.: 99144

Trolley for max. 2 x table 80_M_CHAFING-DISH



weight: 65 kg [empty] / 157 kg [full]

STAGE_80_XS_CHAFING-DISH_1

Item No.: 81080100402

[LxWxH]: 800 x 800 x 775 mm
weight: 32,5 kg

Base

2 x main frame 6,6 kg
2 x table leg 6,2 kg
steel, powder-coated anthracite (100)
profile 40 x 40 mm, with height
compensation

4 x Castor

diameter = 65 mm
weight: 0,5 kg

Height adjustable:

775 mm (lowest height)
855, 935, 1015 mm

Table-Top

compact panel, 10 mm,
decor: ceramic anthracite
weight: 18,0 kg

1 x Magnetic cable duct

[LxWxH]: 770 x 35 x 21 mm
weight: 0,965 kg
steel, 1 mm, bended, powder-coated
anthracite

1 x Magnetic holder

[LxWxH]: 173 x 66 x 23 mm
weight: 0,186 kg
steel, 1 mm, bended, powder-coated
anthracite

delivery content:

including 1 x inlay panel to
close the opening, without
chafing-dish

**MATERIAL+COLOR****basic**

base: 100,101
table-top: 401, 402

option

all available colors in chapter
MATERIAL+COLOR

system suitable for
chafing-dish units
by WMF

combination of STAGE_80_M_CHAFING-DISH_3
and STAGE_80_XS_CHAFING-DISH_1



top view

**Item No.:** 99145

Trolley for max. 2 x table 80_XS_CHAFING-DISH

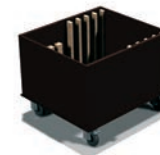

weight: 50 kg [empty] / 104 kg [full]

STAGE_50_M_CHAFING-DISH_2

Item No.: 51042100402

[LxWxH]: 1800 x 500 x 855 mm
weight: 39,4 kg

Base

2 x main frame 10,6 kg
2 x table leg 5,0 kg
steel, powder-coated anthracite (100)
profile 40 x 40 mm, with height
compensation

delivery content:

including 2 x inlay panel to
close the openings, without
chafing-dish

4 x Castor

diameter = 65 mm
weight: 0,5 kg

Height adjustable:

855 mm (lowest height)
935, 1015, 1095 mm

Table-Top

compact panel, 10 mm,
decor: ceramic anthracite
weight: 21,0 kg

1 x Magnetic cable duct

[LxWxH]: 770 x 35 x 21 mm
weight: 0,965 kg
steel, 1 mm, bended, powder-coated
anthracite

2 x Magnetic holder

[LxWxH]: 173 x 66 x 23 mm
weight: 0,186 kg
steel, 1 mm, bended, powder-coated
anthracite

perfect system
to present warm food in
integrated chafing-dish



MATERIAL+COLOR

basic

base: 100, 101
table-top: 401, 402

option

all available colors in chapter
MATERIAL+COLOR

combination of STAGE_50_M_CHAFING-DISH_2
and STAGE_50_XS_CHAFING-DISH_1 + SHELF



top view



Item No.: 99144

Trolley for max. 2 x table 50_M_CHAFING-DISH



weight: 65 kg [empty] / 154 kg [full]

STAGE_50_XS_CHAFING-DISH_1

Item No.: 51043100402

[LxWxH]: 800 x 800 x 775 mm
weight: 29,1 kg

Base

2 x main frame 6,6 kg
2 x table leg 5,0 kg
steel, powder-coated anthracite (100)
profile 40 x 40 mm, with height
compensation

delivery content:

including 1 x inlay panel to
close the opening, without
chafing-dish

4 x Castor

diameter = 65 mm
weight: 0,5 kg

Height adjustable:

775 mm (lowest height)
855, 935, 1015 mm

Table-Top

compact panel, 10 mm,
decor: ceramic anthracite
weight: 13,4 kg

1 x Magnetic cable duct

[LxWxH]: 770 x 35 x 21 mm
weight: 0,965 kg
steel, 1 mm, bended, powder-coated
anthracite

1 x Magnetic holder

[LxWxH]: 173 x 66 x 23 mm
weight: 0,186 kg
steel, 1 mm, bended, powder-coated
anthracite



MATERIAL+COLOR

basic

base: 100,101
table-top: 401, 402

option

all available colors in chapter
MATERIAL+COLOR

system suitable for
chafing-dish units
by WMF

combination of STAGE_50_M_CHAFING-DISH_2
and STAGE_50_XS_CHAFING-DISH_1



top view



Item No.: 99145

Trolley for max. 2 x table 50_XS_CHAFING-DISH

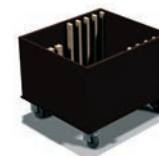

weight: 50 kg [empty] / 124 kg [full]

STAGE – CHAFING-DISH System

simple, functional, easy to handle

Buffet tables with openings to install CHAFING-DISH units, which are fully integrated in the table surface. VENTA recommends to use SPRING or WMF units as we designed a special magnetic holder to place the remote control direct under the table.

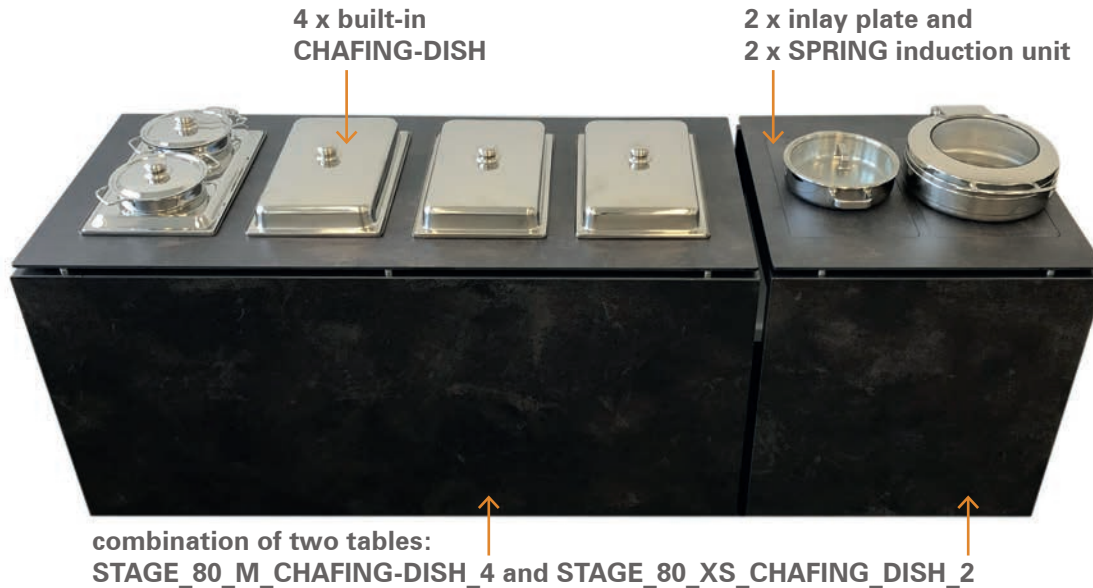

CHAFING-DISH – additional equipment

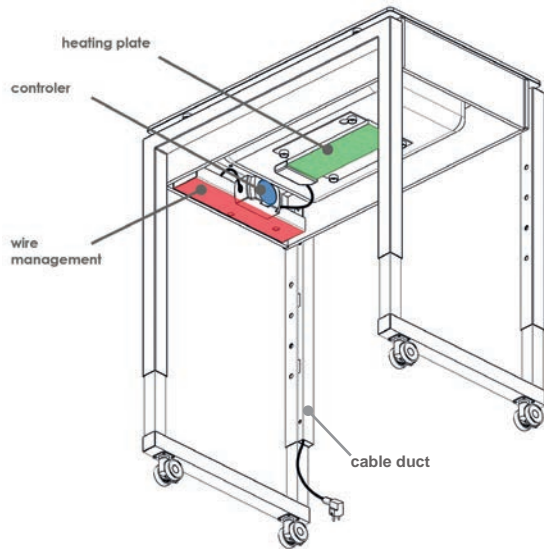

built-in chafing-dish
ECO_SPRING



Item No.: 12300

electric heating unit
SPRING



Item No.: 12301

SPRING induction unit
1000W round



Item No.: 12303

inlay_plate_induction_STA-
GE_CHAFING-DISH



Item No.: 14063

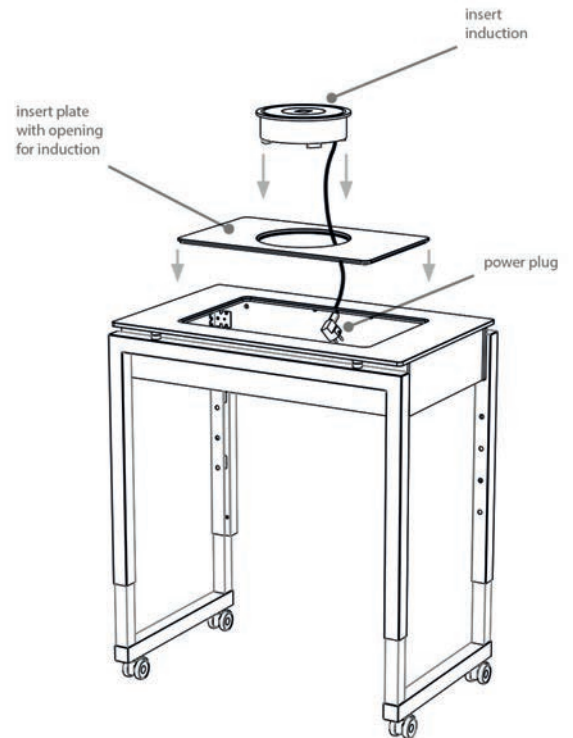

Cold Buffet

cooling with electrical devices



Item No.: 81063101401



BAIN-MARIE

The buffet table **STAGE_80_XS_BAIN-MARIE_COOL+HOT** is a stainless steel basin of size 2/1 GN which contains a COOL+HOT unit.

This technology was developed by Höller, one of a small number of companies worldwide who offer this technology in small and convenient units. This cold-hot plate enables you to keep dishes cool at temperatures as low as -5°C or to switch on the heating function. A hot plate keeps dishes warm. This has the added benefit that you do not have to use induction-compatible cookware, but can also use porcelain cookware, for example.

The buffet table has an area of 80 x 80 cm, while the integrated hob measures GN 2/1 (i.e. 66 x 53 cm). Power is supplied via a standard power cable (230 V). Heavy current is not required.

The equipment runs very quietly and energy-efficiently.



Item No.: 81063101401 (different types of use)

STAGE_80_XS_BAIN-MARIE_COOL+HOT

Item No.: 81063100402

[LxWxH]: 800 x 800 x 775 mm
(adj. height: 855, 935, 1015 mm)
weight: 71,6 kg

Base

steel, powder-coated anthracite
profile 40 x 40 mm, on wheels
with height compensation,
weight: 13,6 kg

Table-Top

compact panel, 790 x 790 x 10 mm,
decor: ceramic anthracite
weight: 3,9 kg

-5°C/ +140°C

temperature range
at ambient temperature of 24°C



height can be
adjusted
(76 - 100 cm)

MATERIAL+COLOR

basic

base: 100,101
table-top: 401, 402

option

all available colors in chapter
MATERIAL+COLOR

Inlay

compact panel, 10 mm,
ceramic anthracite
weight: 2,6 kg (each inlay)

COOL+HOT-unit

size: 2/1 GN (660 x 530 mm)
stainless steel (inside)
metal housing (outside)
powder-coated
weight: 48,9 kg

COOL or HOT
combined in one table

The HOT-mode keeps the
food warm. **No cooking !**

suitable for 2/1 GN
size: 650 x 507 mm
depth: 105 mm



delivery content:
including 2 x inlay panel
to close the opening

multifunctional well Hot-Cold (2/1 GN)
measures: 770 x 630 x 250 mm



features: multifunctional well Hot-Cold with two
inlays, Bain-Marie: adjustable from 30°C up to
110°C/static cooling: up to -5°C, max. ambient
temperature 25°C, CW unit: GN 2/1, 230V, heat
output: 1800 Watt, coolant: R600a, cooling
output: 140 Watt



STAGE_50_XS_BAIN-MARIE_COOL+HOT

STAGE_50_XS_BAIN-MARIE_COOL+HOT

Item No.: 51025100402

[LxWxH]: 800 x 500 x 775 mm
(ad. height: 855, 935, 1015 mm)
weight: 52,6 kg

Base

steel, powder-coated anthracite
profile 40 x 40 mm, on castors
with height compensation
weight: 12,6 kg

Table-Top

compact panel, 790 x 490 x 10 mm,
decor: ceramic anthracite
weight: 3,0 kg

-5°C/ +140°C

temperature range
at ambient temperature of 24°C

height can be
adjusted
(76 - 100 cm)

MATERIAL+COLOR

basic

base: 100, 101
table-top: 401, 402

option

all available colors in chapter
MATERIAL+COLOR



Inlay

compact panel, 10 mm,
ceramic anthracite
weight: 1,3 kg (each inlay)

COOL+HOT-unit

size: 1/1 GN (530 x 325 mm)
stainless steel (inside)
metal housing (outside)
powder-coated
weight: 34,4 kg

COOL or HOT
combined in one table

The HOT-mode keeps the
food warm. **No cooking !**

suitable for 1/1 GN
size: 507 x 303 mm
depth: 105 mm

multifunctional well Hot-Cold (1/1 GN)
measures: 425 x 630 mm



explosion view /
single parts



delivery content:
including 2 x inlay panel
to close the opening

Item No.: 81006101401303



COOL+HOT table

Another technical gem is our STAGE_80_XS_COOL+HOT buffet table with a glass surface, which houses a cold-hot plate.

This technology was developed by Höller, one of a small number of companies worldwide who offer this technology in small and convenient units. This cold-hot plate enables you to keep dishes cool at temperatures as low as -5°C or to switch on the heating function. A hot plate keeps dishes warm. This has the added benefit that you do not have to use induction-compatible cookware, but can also use porcelain cookware, for example.

The buffet table has an area of 80 x 80 cm, while the integrated hob measures GN 2/1 (i.e. 66 x 53 cm). Power is supplied via a standard power cable (230 V). Heavy current is not required.

The equipment runs very quietly and energy-efficiently.

STAGE_80_XS_COOL+HOT

Item No.: 81006100402307

[LxWxH]: 800 x 800 x 775 mm
(ad. height: 855, 935, 1015 mm)
weight: 60 kg

Base

steel, powder-coated anthracite
profile 40 x 40 mm, on wheels
with height compensation,
weight: 13,6 kg

Table-Top

compact plate 10 mm, 790 x 790 mm,
decor: ceramic anthracite
weight: 4 kg

Cover

metal box, 1,5 mm,
powder-coated anthracite
weight: 12 kg

COOL+HOT-unit

size: 2/1 GN (660 x 530 mm)
glass-top, black colored (307)
or white colored (303)
weight: 26 kg

COOL or **HOT**
combined in one table

>>> **ONLY** available as
STAGE_80_XS table.



height can be
adjusted
(76 - 100 cm)

MATERIAL+COLOR

basic

base: 100,101
table-top: 401, 402

option

all available colors in chapter
MATERIAL+COLOR

connection between table-top and base



explosion view/main parts

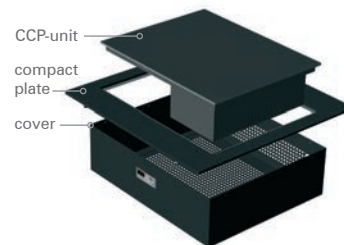

dismantling the cover for service



Benefits

-3°C / +120°C
temperature range

The HOT-mode keeps the food warm, **no cooking!**

SIZE: 2/1 GN
660 x 530 mm

maximum load: 80 kg



CCP (comfort-combi-plate) 2/1 GN
measures: 660 x 530 mm



technical details:
CCP built-in system, 2/1 GN, size: 660 x 530 mm,
height: 190 mm, power supply: 230V, heat output:
1400W, coolant: R600a, cooling output: 140W



touch panel on the front of the table



Cold Buffet

cooling with ice cubes and cooling plates



Item No.: 81007101303



COOL table

Our exclusive STAGE_80_XS_COOL table with integrated cold plates works without the need for any power cables.

You place this table anywhere in the room – no need for power sockets.

Before use, the cold plates must be stored in the freezer room of the hotel or event location for around twelve hours at -18°C. Then the COOL table can be used for approximately five hours.

The temperature of the table surface is approx. 5°C. The table is designed for indoor use with an ambient temperature of approx. 21°C.

Use at higher temperatures is not recommended, as the result will not be satisfactory.

Do not install a sneezeguard on this table, as the table-top should be free to exchange the COOL_PLATES.

STAGE_80_XS_COOL

Item No.: 81007100307

[LxWxH]: 800 x 800 x 775 mm
weight: 48,6 kg

Base

2 x main frame 6,6 kg
2 x table leg 6,2 kg
steel, powder-coated anthracite (100)
profile 40 x 40 mm, with height
compensation

Bowl_80_XS_COOL

metal, powder-coated, anthracite
weight: 8,3 kg

Table-top

safety glass 10 mm, 790 x 790 mm,
underside black colored,
weight: 15 kg

COOL_PLATE (4x)

350 x 350 x 26 mm
polystyrene, color: black
weight: 2,4 kg

4 x Castor

diameter = 65 mm
weight: 0,5 kg

works only with
glass surface

height can be
adjusted
(77,5 - 100,5 cm)



MATERIAL+COLOR

basic

base: 100, 101
table-top: 303, 307

option

all available colors in chapter
MATERIAL+COLOR

5h cooling 5°-10°C on the table surface without electricity

Preparation:
Place the COOL-PLATE for 12
hours inside a freezer at -18°C
in vertical position.

Item No.: 66003 / COOL_PLATE

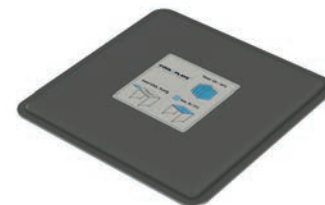

explosion view



STAGE_50_XS_COOL

Item No.: 51029100402

[LxWxH]: 800 x 500 x 775 mm
weight: 31,4 kg

Base

2 x main frame 6,6 kg
2 x table leg 5,0 kg
steel, powder-coated anthracite (100)
profile 40 x 40 mm, with height
compensation

Bowl_50_XS_COOL

metal, powder-coated, anthracite
weight: 5,0 kg

Table-top

safety glass 10 mm, 790 x 490 mm,
underside black colored,
weight: 9,5 kg

COOL_PLATE (2x)

350 x 350 x 26 mm
polystyrene, color: black
weight: 2,4 kg

4 x Castor

diameter = 65 mm
weight: 0,5 kg

works only with
glass surface

height can be
adjusted
(77,5 - 100,5 cm)



MATERIAL+COLOR

basic

base: 100,101
table-top: 303, 307

option

all available colors in chapter
MATERIAL+COLOR

5h cooling

5°-10°C

on the table surface
without electricity

Preparation:
Place the COOL_PLATE for 12
hours inside a freezer at -18°C
in vertical position.

Item No.: 99129 / Trolley_COOL_PLATES_8



Item No.: 99132 / Trolley_COOL_PLATES_4B



weight: 62,3 kg [empty] / 139,1 kg [full]

Item No.: 81092101401



STAGE_80_XS_ICE_WELL

The ICE WELL with a depth of 20 cm is designed for cooling bottles. The entire well is filled with ice cubes. The well is equipped with a drainage tap and thus offers the possibility to drain the entire contents (melted ice = water) after use. A bucket can be placed under the table when the shut-off valve gets opened. In addition, a 1/1 GN grid basket can be used in the ice well. In this way the not yet melted ice can be easily removed. The ice well is available in two sizes (80 x 80 cm and 50 x 80 cm) for a buffet depth of 80 cm. The tub can be closed with the supplied insert plates (two pieces each) so that the table-top can be used as a shelf.



Useful Equipment

The perforated 1/1 GN container helps to remove the ice cubes out of the ICE WELL.

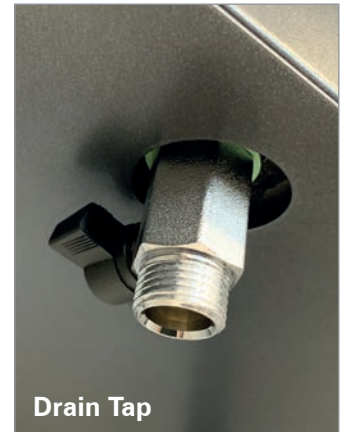

Drain Tap

STAGE_80_XS_ICE_WELL

Item No.: 81092100402

[LxWxH]: 800 x 800 x 775 mm
weight: 47,3 kg

Base

2 x main frame 6,6 kg
2 x table leg 6,2 kg
steel, powder-coated anthracite (100)
profile 40 x 40 mm, with height
compensation

4 x Castor

diameter = 65 mm
weight: 0,5 kg

Height adjustable / grid = 80 mm

775 mm (lowest height)
855, 935, 1015 mm

Table-top

compact laminate 10 mm,
ceramic anthracite (402)
weight: 4,2 kg

Housing_80_XS_ICE_WELL

metal, powder-coated, anthracite
weight: 22,2 kg

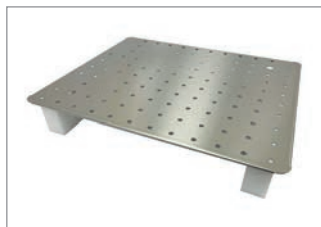

inlay for reducing the ice well depth,
2/1 GN, three heights (50, 100, 150
mm) adjustable by using the
distance block in different positions

table opening closed with lid



explosion view



height can be
adjusted
(77,5 - 101,5 cm)

MATERIAL+COLOR

basic

base: 100, 101
table-top: 401, 402

option

all available colors in chapter
MATERIAL+COLOR

delivery content:
including 2 x inlay panel
to close the opening

STAGE_50_XS_ICE_WELL

Item No.: 51049100402

[LxWxH]: 800 x 500 x 775 mm
weight: 35,0 kg

Base

2 x main frame 6,6 kg
2 x table leg 5,0 kg
steel, powder-coated anthracite (100)
profile 40 x 40 mm, with height
compensation

4 x Castor

diameter = 65 mm
weight: 0,5 kg

Height adjustable:

775 mm (lowest height)
855, 935, 1015 mm

Table-top

compact laminate 10 mm,
ceramic anthracite (402)
weight: 3,3 kg

Housing_50_XS_ICE_WELL

metal, powder-coated, anthracite
weight: 14,1 kg



inlay for reducing the ice well depth,
1/1 GN, three heights (50, 100, 150
mm) adjustable by using the
distance block in different positions

table opening closed with lid



explosion view



height can be
adjusted
(77,5 - 101,5 cm)

MATERIAL+COLOR

basic

base: 100,101
table-top: 401, 402

option

all available colors in chapter
MATERIAL+COLOR

delivery content:

including 2 x inlay panel
to close the opening

ELEMENTS

modular cooking and buffet system | AIRMOBIL – mobile exhaust



ELEMENTS®

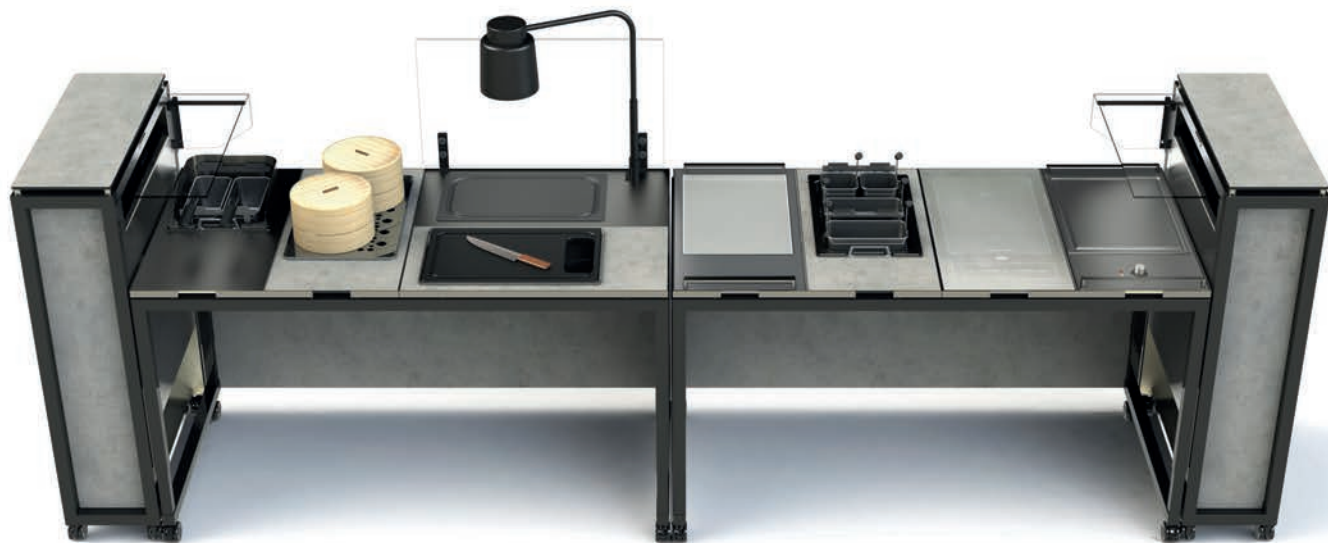

Modular Cooking System

The latest addition to our buffet tables now concerns live cooking/front cooking, the experience of cooking and serving in front of the guests, so that every event becomes a highlight. The top priority in the development was that VENTA customers can use their already purchased tables for the live cooking stations. Furthermore, the flexibility and mobility of the familiar systems was to be increased. True to the motto “everybody can be bigger” we chose the smallest of the four buffet tables from our Stage Buffet System as the output of the latest development. The smallest square buffet table STAGE 80 XS with the dimensions 80 x 80 cm, which is available twice in a STAGE 80 buffet set, was thus the basis for the new VENTA Elements, our modular system for modern and contemporary live cooking / front cooking, which meets all the requirements of the most varied F & B concepts in countries all over the world.

Instead of the glass or compact table-top, a square ELEMENTS table frame made of stainless steel is now placed on the existing table frame. The square dimension has the advantage that the table frame can be used both lengthwise and crosswise, so that all available thermal equipment and inserts can be inserted into the Elements table frame not only lengthwise but also crosswise and can be used in different ways in daily use. In order to be able to use our Elements live cooking system/front cooking system indoors, a mobile extraction unit had to be developed and designed especially for table size XS, which fully meets today’s requirements for odourless cooking in closed rooms. With its external dimensions of 80 x 30 cm, our Airmobil can be placed precisely (tailor-made) to the right, left or in front of a STAGE 80 XS ELEMENTS live cooking table and can thus be adapted to the daily changing requirements in the areas of construction and concept of a flexible and modular live cooking station.

homepage: <https://ventadesign.com/elements-live-cooking-system/#>

catalogue: <https://ventadesign.com/info/ventadesign-elements-presentation.pdf>





INDUCTION_COOK_ELEMENTS
Item No.: 20009



TEPPAN_GRILL_ELEMENTS
Item No.: 20009



PASTA_SET
Item No.: 20022



FRYING_SET
Item No.: 20023



CHAFING_DISH_SET
Item No.: 20028



SOUP_SET
Item No.: 20026

DIM_SUM_SET
Item No.: 20034



COMPACT_TOP_ELEMENTS
Item No.: 20012 (20029)

STAINLESS_TOP_ELEMENTS
Item No.: 20013

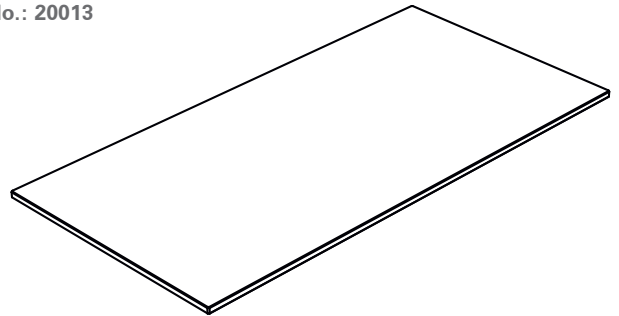



COOL+HOT_ELEMENTS
Item No.: 20011

COMPACT_TOP_ELEMENTS_ICE_WELL

Item No.: 20040/20041
including 1 x inlay panel
to close the ice well

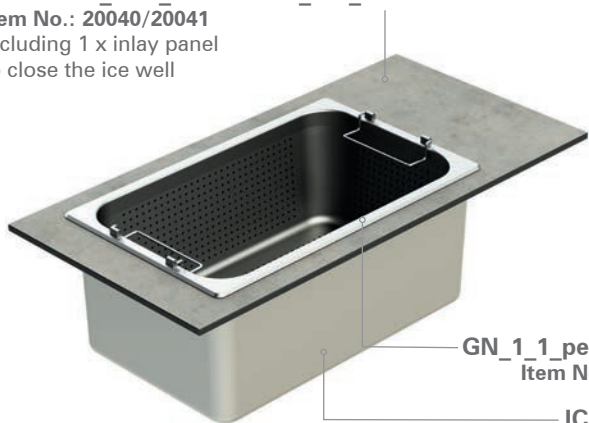

GN_1_1_perforated
Item No.: 12309

ICE_WELL
Item No.: 20017



CARVING_SET
Item No.: 20024



AIRMOBIL_80
Item No.: 66039

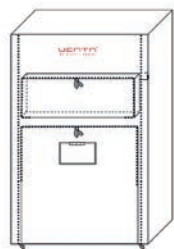
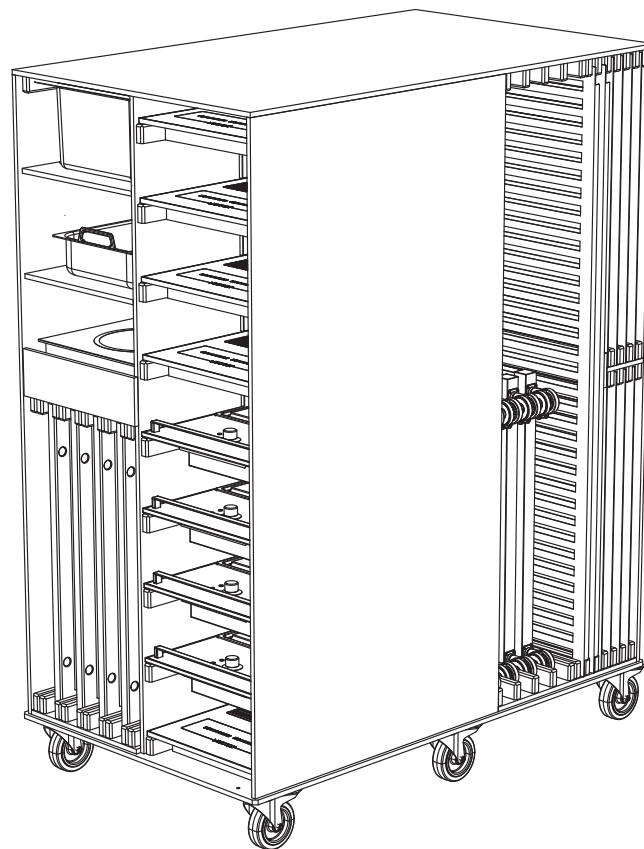

PROTECTIVE COVER
AIRMOBIL_80
Item No.: 78011



TROLLEY
AIRMOBIL_80
Item No.: 99148

TROLLEY_STAGE_ELEMENTS
Item No.: 99149

alternative equipment for usage on INDUCTION_COOK unit

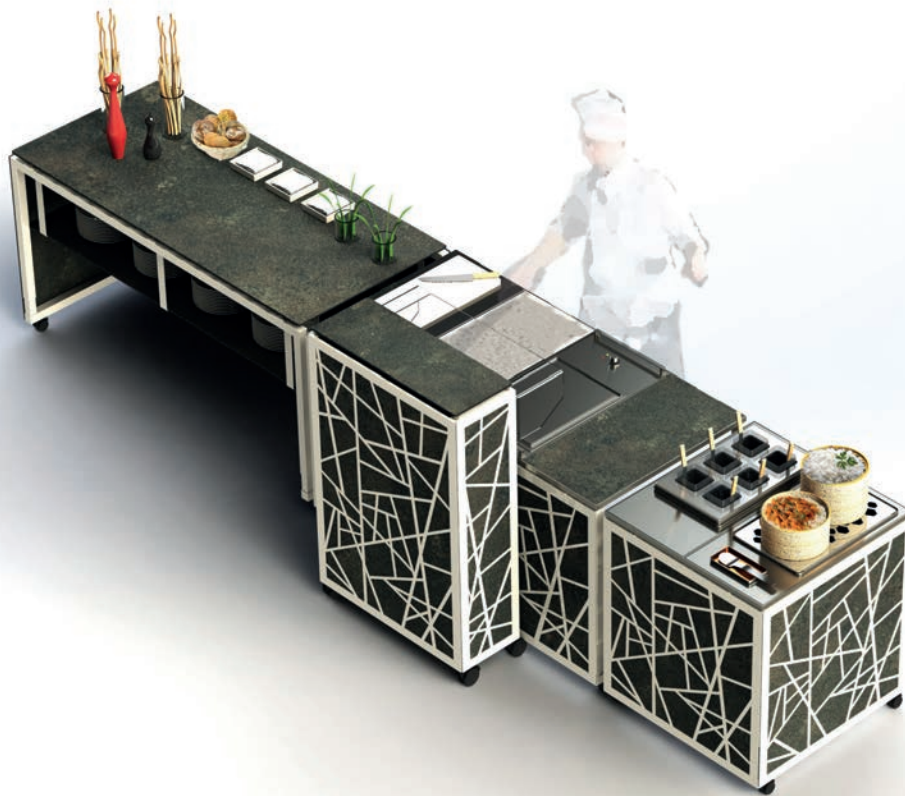

WOK
Item No.: 12339



more flexibility with flat bottom wok

WOK
Item No.: 12340



more flexibility with flat bottom wok

GRILL PLATE
Item No.: 12316



alternative product to teppan grill unit



plugbar_
CEE_400V_3x16A_3600W
Item No.: 11162



plugbar_
UK_230V_13A_3200W
Item No.: 11163

also available as single items:
table frame_STAGE_80_ELEMENTS
Item No.: 20007

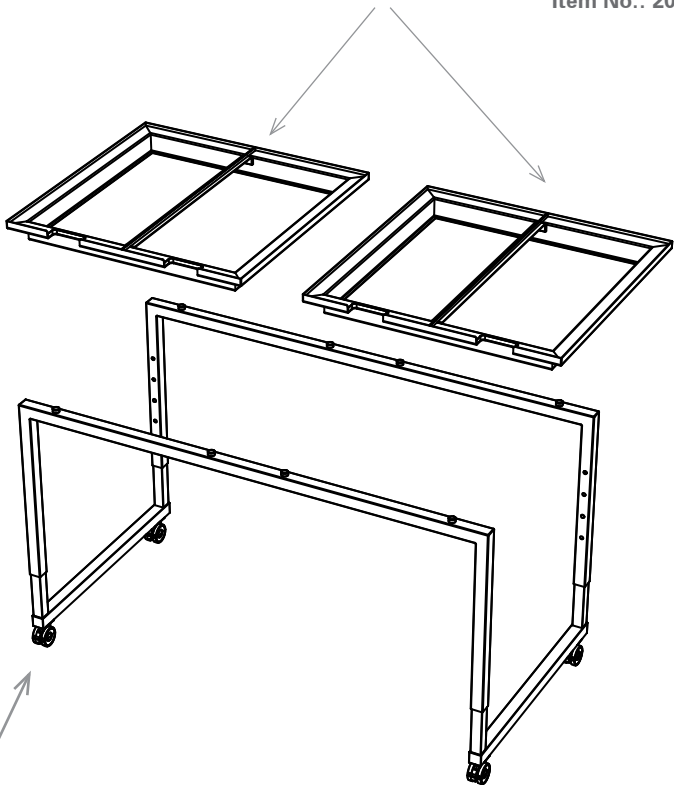

STAGE_80_S_ELEMENTS
Item No.: 20101

ELEMENTS

Important advices to select the correct equipment.

We recommend to mount always BLINDS on every ELEMENTS station (S and XS) to hide the installed equipment, the cables and any additional cooking utensils.

The CARVING STATION can only be equipped at the FRONT with compact laminate blinds. The decorative metal blinds will not fit at the front, as the mounted shield and the heat lamp do not allow the correct mounting.

The same situation is valid for an additional, separate mounting of a STAY HOT heat lamp at the front of a S or XS table.



ELEMENTS

Power Management

We recommend to discuss with us the electrical situation in your property and to create a plan for power cable management.

This will help you to select all necessary cables and power strips according to your local situation.

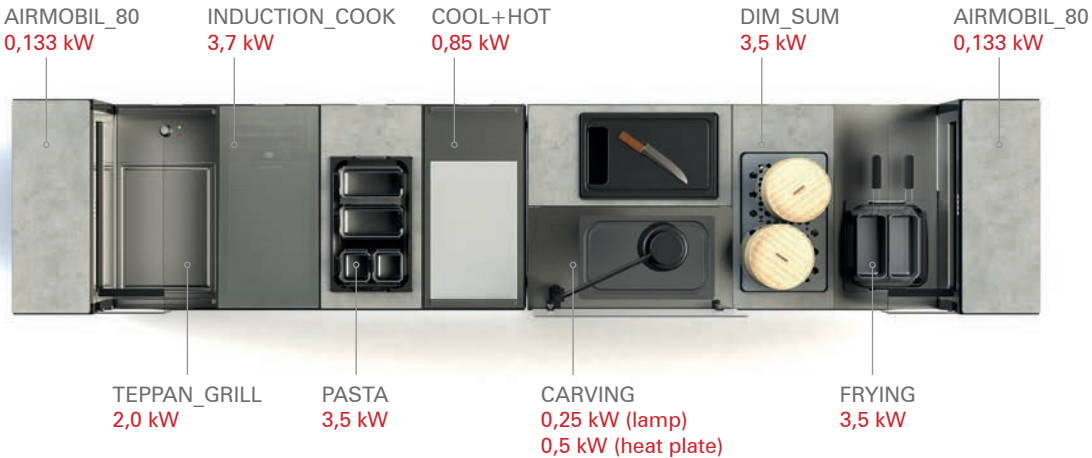

VENTA recommendation = 2 x plugbar 400V + 1 x plugbar 230V / alternative solution = 1 x plugbar 230V + 7 x extension cable 5m (use on individually fused 16A sockets)

Buffet Accessories

Blind | Shelf | Heat Bridge | Sneeze Guard | Front Shield | Etagere | Plate Warmer



FRONTBLIND_STAGE_BAMBOO_COV.

FRONTBLIND_STAGE_L_BAMBOO

Item No.: 38036100622

[LxWxH]: 1960 x 822 x 17 mm

weight: 14,0 kg

FRONTBLIND_STAGE_M_BAMBOO

Item No.: 38037100622

[LxWxH]: 1800 x 822 x 17 mm

weight: 13,0 kg

FRONTBLIND_STAGE_S_164_BAMBOO

Item No.: 38038100622

[LxWxH]: 1640 x 822 x 17 mm

weight: 9,0 kg

FRONTBLIND_STAGE_S_BAMBOO

Item No.: 38039100622

[LxWxH]: 1600 x 822 x 17 mm

weight: 8,0 kg

FRONTBLIND_STAGE_XS_BAMBOO

Item No.: 38040100622

[LxWxH]: 800 x 822 x 17 mm

weight: 6,5 kg

**suitable for all STAGE tables
buffet height = 93,5 cm**

**FRONTBLINDS/available in five
sizes/suitable for L, M, S_164, S
and XS length**



MATERIAL+COLOR

basic

base: 100, 101

cover: 620, 621, 622

option

all available colors in chapter

MATERIAL+COLOR

side view 1

side view 2

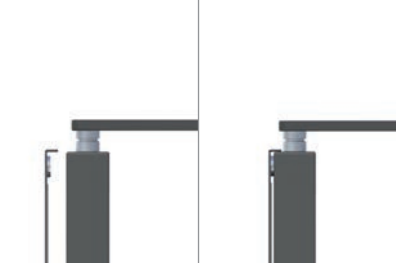

mounting by magnets
and small hooks

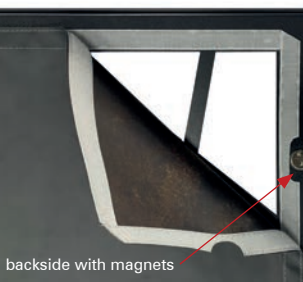
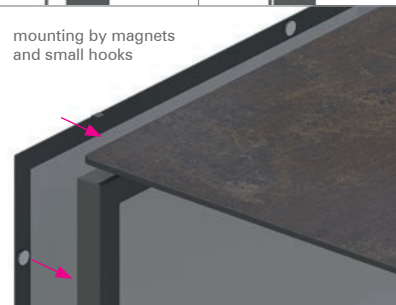

backside with magnets

SIDEBLIND_STAGE_BAMBOO_COV.

SIDEBLIND_STAGE_80_BAMBOO

Item No.: 38041100622

[LxWxH]: 800 x 822 x 17 mm

weight: 6,5 kg

SIDEBLIND_STAGE_50_BAMBOO

Item No.: 38042100622

[LxWxH]: 500 x 822 x 17 mm

weight: 5,0 kg

**suitable for all STAGE tables
buffet height = 93,5 cm**

**SIDEBLINDS/available
in two sizes for 80 and
50 cm buffet depth**



MATERIAL+COLOR

basic

base: 100,101

cover: 620, 621, 622

option

all available colors in chapter

MATERIAL+COLOR

side view 1

side view 2

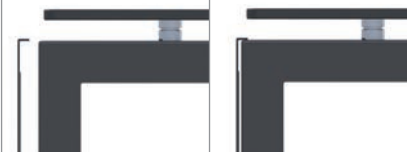

mounting by magnets
and long hook

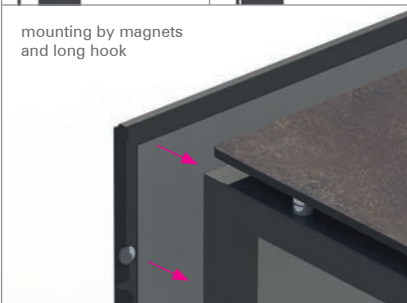

FRONTBLIND_STAGE_LEAF_COV.

FRONTBLIND_STAGE_L_LEAF

Item No.: 38022100622

[LxWxH]: 1960 x 822 x 17 mm

weight: 14,0 kg

FRONTBLIND_STAGE_M_LEAF

Item No.: 38023100622

[LxWxH]: 1800 x 822 x 17 mm

weight: 13,0 kg

FRONTBLIND_STAGE_S_164_LEAF

Item No.: 38024100622

[LxWxH]: 1640 x 822 x 17 mm

weight: 9,0 kg

FRONTBLIND_STAGE_S_LEAF

Item No.: 38025100622

[LxWxH]: 1600 x 822 x 17 mm

weight: 8,0 kg

FRONTBLIND_STAGE_XS_LEAF

Item No.: 38026100622

[LxWxH]: 800 x 822 x 17 mm

weight: 6,5 kg

**suitable for all STAGE tables
buffet height = 93,5 cm**

**FRONTBLINDS/available in five
sizes/suitable for L, M, S_164, S
and XS length**



MATERIAL+COLOR

basic

base: 100, 101

cover: 620, 621, 622

option

all available colors in chapter

MATERIAL+COLOR

side view 1

side view 2

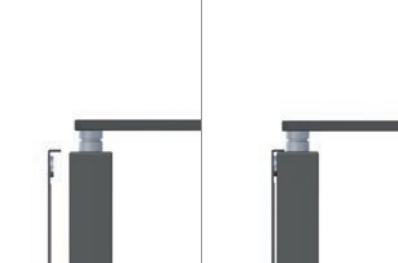

mounting by magnets
and small hooks

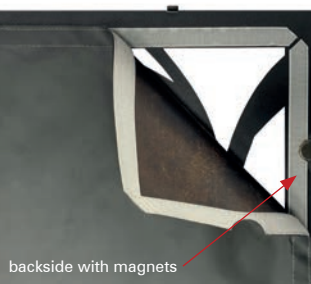
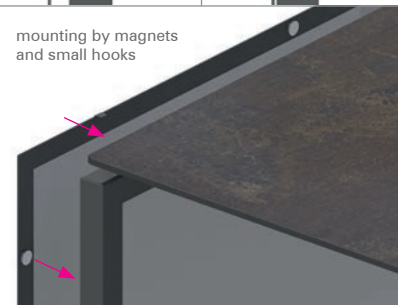

backside with magnets

SIDEBLIND_STAGE_LEAF_COV.

SIDEBLIND_STAGE_80_LEAF

Item No.: 380427100622

[LxWxH]: 800 x 822 x 17 mm

weight: 6,5 kg

SIDEBLIND_STAGE_50_LEAF

Item No.: 38028100622

[LxWxH]: 500 x 822 x 17 mm

weight: 5,0 kg

**suitable for all STAGE tables
buffet height = 93,5 cm**

**SIDEBLINDS/available
in two sizes for 80 and
50 cm buffet depth**



MATERIAL+COLOR

basic

base: 100,101

cover: 620, 621, 622

option

all available colors in chapter

MATERIAL+COLOR

side view 1

side view 2



mounting by magnets
and long hook

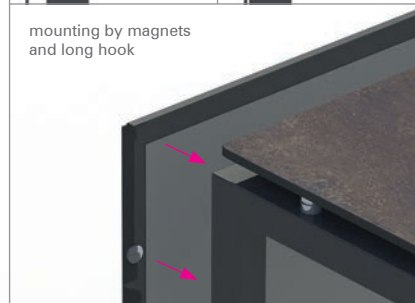

FRONTBLIND_STAGE_STRIPES_COV.

FRONTBLIND_STAGE_L_STRIPES

Item No.: 38062100622

[LxWxH]: 1960 x 822 x 17 mm

weight: 14 kg

FRONTBLIND_STAGE_M_STRIPES

Item No.: 38063100622

[LxWxH]: 1800 x 822 x 17 mm

weight: 13 kg

FRONTBLIND_STAGE_S_164_STRIPES

Item No.: 38064100622

[LxWxH]: 1640 x 822 x 17 mm

weight: 11,8 kg

FRONTBLIND_STAGE_S_STRIPES

Item No.: 38065100622

[LxWxH]: 1600 x 822 x 17 mm

weight: 11,4 kg

FRONTBLIND_STAGE_XS_STRIPES

Item No.: 38066100622

[LxWxH]: 800 x 822 x 17 mm

weight: 5,8 kg

**suitable for all STAGE tables
buffet height = 93,5 cm**

**FRONTBLINDS/available in five
sizes/suitable for L, M, S_164, S
and XS length**

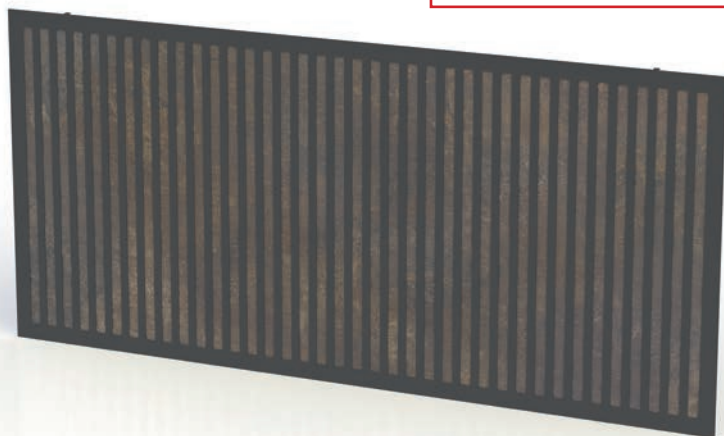

MATERIAL+COLOR

basic

base: 100, 101

cover: 620, 621, 622

option

all available colors in chapter

MATERIAL+COLOR

side view 1

side view 2

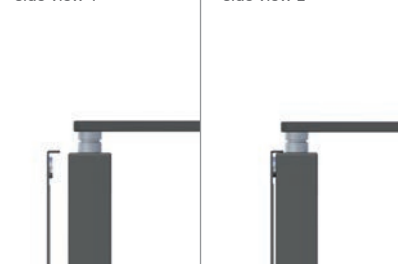

mounting by magnets
and small hooks

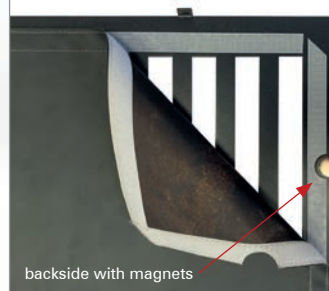
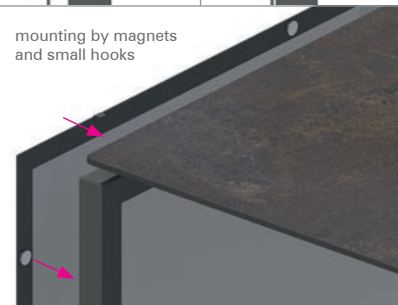

backside with magnets

SIDEBLIND_STAGE_STRIPES_COV.

SIDEBLIND_STAGE_80_STRIPES

Item No.: 38067100622

[LxWxH]: 800 x 822 x 17 mm

weight: 5,8 kg

SIDEBLIND_STAGE_50_STRIPES

Item No.: 38068100622

[LxWxH]: 500 x 822 x 17 mm

weight: 5,0 kg

**suitable for all STAGE tables
buffet height = 93,5 cm**

**SIDEBLINDS/available
in two sizes for 80 and
50 cm buffet depth**



MATERIAL+COLOR

basic

base: 100,101

cover: 620, 621, 622

option

all available colors in chapter

MATERIAL+COLOR

side view 1

side view 2



mounting by magnets
and long hook

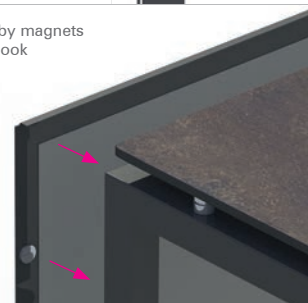

FRONTBLIND_STAGE

FRONTBLIND_STAGE_L

Item No.: 38043100402

[LxWxH]: 1960 x 822 x 17 mm

weight: 6,5 kg

FRONTBLIND_STAGE_M

Item No.: 38044100402

[LxWxH]: 1800 x 822 x 17 mm

weight: 6,0 kg

FRONTBLIND_STAGE_S_164

Item No.: 38045100402

[LxWxH]: 1640 x 822 x 17 mm

weight: 5,5 kg

FRONTBLIND_STAGE_S

Item No.: 38046100402

[LxWxH]: 1600 x 822 x 17 mm

weight: 5,3 kg

FRONTBLIND_STAGE_XS

Item No.: 38047100402

[LxWxH]: 800 x 822 x 17 mm

weight: 2,7 kg

**suitable for all STAGE tables
buffet height = 93,5 cm**

**FRONTBLINDS/available in five
sizes/suitable for L, M, S_164, S
and XS length**



MATERIAL+COLOR

basic

base: 100, 101

cover: 401, 402

option

all available colors in chapter

MATERIAL+COLOR

side view 1

side view 2

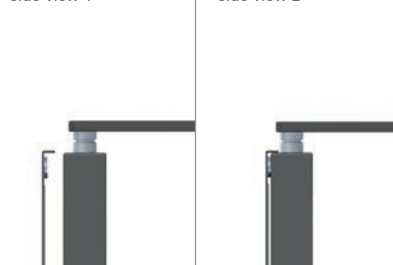

mounting by magnets
and small hooks

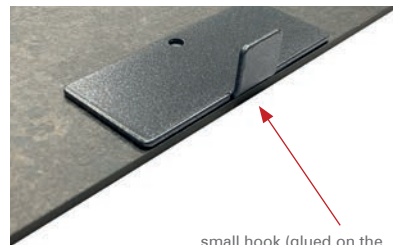
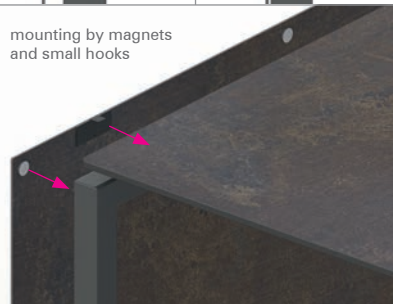

small hook (glued on the
compact laminate panel)

SIDEBLIND_STAGE

SIDEBLIND_STAGE_80

Item No.: 38048100402

[LxWxH]: 800 x 822 x 17 mm

weight: 2,7 kg

SIDEBLIND_STAGE_50

Item No.: 38049100402

[LxWxH]: 500 x 822 x 17 mm

weight: 1,7 kg

**suitable for all STAGE tables
buffet height = 93,5 cm**

**SIDEBLINDS/available
in two sizes for 80 and
50 cm buffet depth**



MATERIAL+COLOR

basic

base: 100,101

cover: 401, 402

option

all available colors in chapter

MATERIAL+COLOR

side view 1

side view 2



mounting by magnets
and long hook

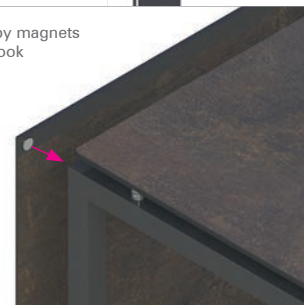

long hook (glued on the
compact laminate panel)



FRONTBLIND_APERTURE_STAGE

FRONTBLIND_APERTURE_STAGE_L

Item No.: 38057100402

[LxWxH]: 1960 x 822 x 27 mm

weight: 6,5 kg

FRONTBLIND_APERTURE_STAGE_M

Item No.: 38058100402

[LxWxH]: 1800 x 822 x 27 mm

weight: 6,0 kg

FRONTBLIND_APERTURE_STAGE_S_164

Item No.: 38059100402

[LxWxH]: 1640 x 822 x 27 mm

weight: 5,5 kg

FRONTBLIND_APERTURE_STAGE_S

Item No.: 38060100402

[LxWxH]: 1600 x 822 x 27 mm

weight: 5,3 kg

FRONTBLIND_APERTURE_STAGE_XS

Item No.: 38061100402

[LxWxH]: 800 x 822 x 27 mm

weight: 2,7 kg

**suitable for all STAGE tables
buffet height = 93,5 cm**

**FRONTBLINDS/available in five
sizes/suitable for L, M, S_164, S
and XS length**



MATERIAL+COLOR

basic

base: 100,101

cover: 401, 402

option

all available colors in chapter

MATERIAL+COLOR

side view 1

side view 2



mounting by magnets
and small hooks



small hook (glued on the
compact laminate panel)

SHELF_47_STAGE_80

SHELF_47_STAGE_80_L

Item No.: 80083100402

[LxWxH]: 1900 x 728 x 473 mm

weight: 23,6 kg

SHELF_47_STAGE_80_M

Item No.: 80084100402

[LxWxH]: 1740 x 728 x 473 mm

weight: 22,9 kg

SHELF_47_STAGE_80_S_164

Item No.: 80085100402

[LxWxH]: 1580 x 728 x 473 mm

weight: 21,3 kg

SHELF_47_STAGE_80_S

Item No.: 80086100402

[LxWxH]: 1540 x 728 x 473 mm

weight: 22,4 kg

SHELF_47_STAGE_80_XS

Item No.: 80087100402

[LxWxH]: 740 x 728 x 473 mm

weight: 10,6 kg

**FRONTBLIND APERTURE
requires SHELF_47**

opening = 31 cm with APERTURE



MATERIAL+COLOR

basic

base: 100, 101

shelf: 401, 402

option

all available colors in chapter

MATERIAL+COLOR

depth = 80 cm

3 x U-Bolts (size: L / M / S_164)



useable height = 41 cm

4 x U-Bolts (size: S)



useable height = 41 cm

2 x U-Bolts (size: XS)



useable height = 41 cm

SHELF_47_STAGE_50

SHELF_47_STAGE_50_L
Item No.: 50044100402
 [LxWxH]: 1900 x 428 x 473 mm
 weight: 14,2 kg

SHELF_47_STAGE_50_M
Item No.: 50045100402
 [LxWxH]: 1740 x 428 x 473 mm
 weight: 13,9 kg

SHELF_47_STAGE_50_S_164
Item No.: 50046100402
 [LxWxH]: 1580 x 428 x 473 mm
 weight: 13,3 kg

SHELF_47_STAGE_50_S
Item No.: 50047100402
 [LxWxH]: 1540 x 428 x 473 mm
 weight: 14,4 kg

SHELF_47_STAGE_50_XS
Item No.: 50048100402
 [LxWxH]: 740 x 428 x 473 mm
 weight: 6,9 kg

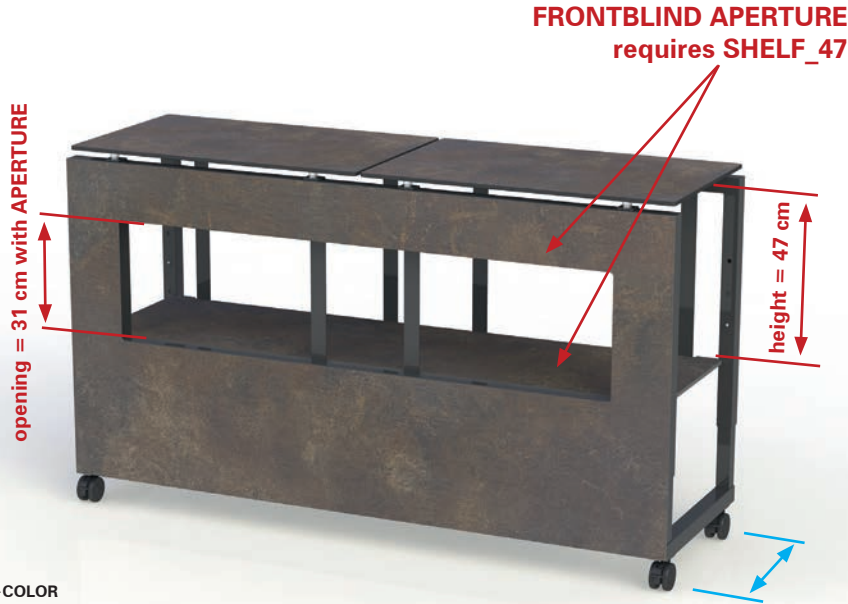

MATERIAL+COLOR

basic
 base: 100,101
 shelf: 401, 402

option
 all available colors in chapter
 MATERIAL+COLOR

3 x U-Bolts (size: L / M / S_164)



useable height = 41 cm

4 x U-Bolts (size: S)



useable height = 41 cm

2 x U-Bolts (size: XS)



useable height = 41 cm

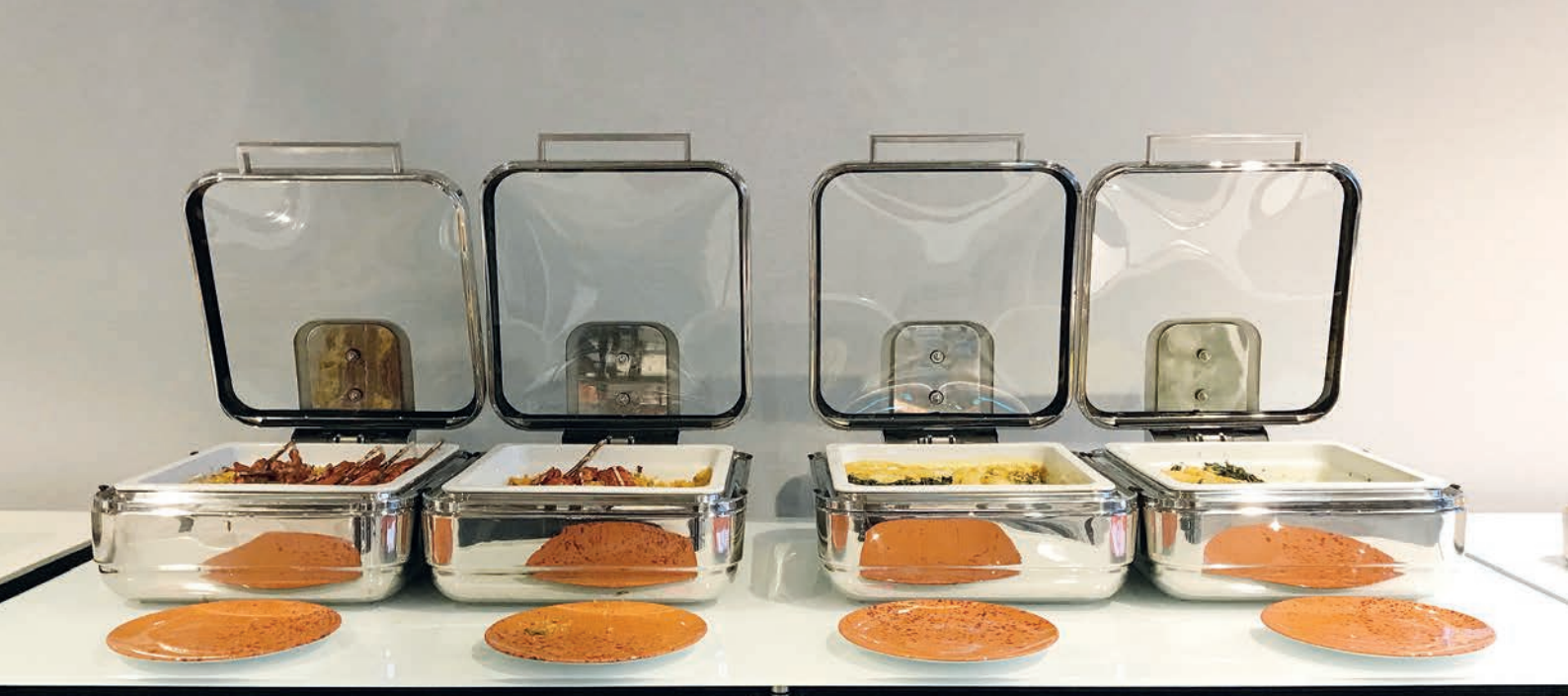

SHELF_STAGE

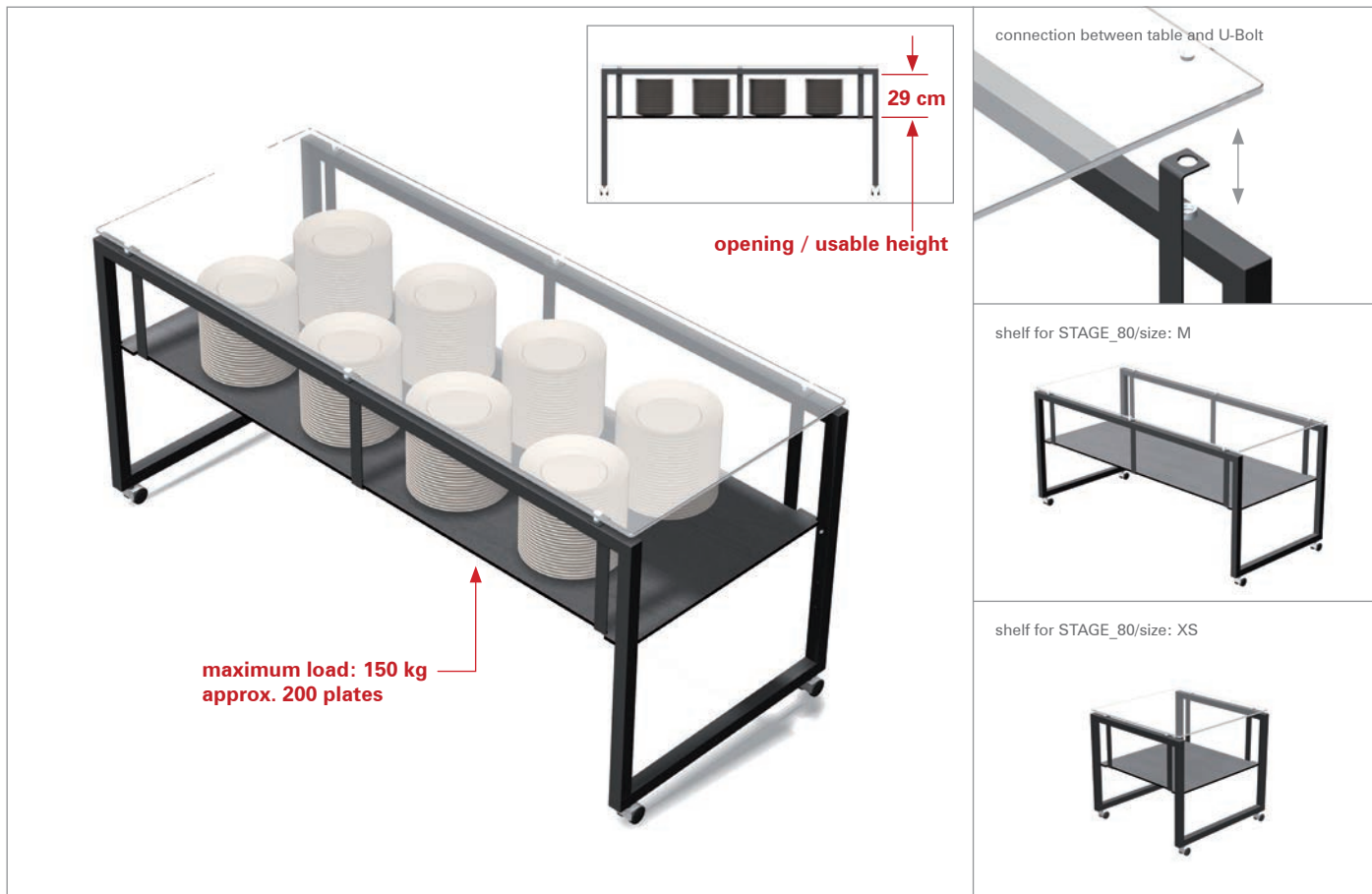

SHELF_STAGE_80

SHELF_STAGE_80_L

Item No.: 80010100402

[LxWxH]: 1900 x 728 x 353 mm

weight: 23,0 kg

SHELF_STAGE_80_M

Item No.: 80011100402

[LxWxH]: 1740 x 728 x 353 mm

weight: 22,3 kg

SHELF_STAGE_80_S_164

Item No.: 80058100402

[LxWxH]: 1580 x 728 x 353 mm

weight: 20,7 kg

SHELF_STAGE_80_S

Item No.: 80038100402

[LxWxH]: 1540 x 728 x 353 mm

weight: 21,6 kg

SHELF_STAGE_80_XS

Item No.: 80012100402

[LxWxH]: 740 x 728 x 353 mm

weight: 10,2 kg



MATERIAL+COLOR

basic

base: 100, 101

shelf: 401, 402

option

all available colors in chapter

MATERIAL+COLOR

depth = 80 cm

3 x U-Bolts (size: L / M / S_164)



useable height = 29 cm

4 x U-Bolts (size: S)



useable height = 29 cm

2 x U-Bolts (size: XS)



useable height = 29 cm

SHELF_STAGE_50

SHELF_STAGE_50_L

Item No.: 50005100402

[LxWxH]: 1900 x 428 x 353 mm

weight: 13,6 kg

SHELF_STAGE_50_M

Item No.: 50006100402

[LxWxH]: 1740 x 428 x 353 mm

weight: 13,3 kg

SHELF_STAGE_50_S_164

Item No.: 50023100402

[LxWxH]: 1580 x 428 x 353 mm

weight: 12,7 kg

SHELF_STAGE_50_S

Item No.: 50021100402

[LxWxH]: 1540 x 428 x 353 mm

weight: 13,6 kg

SHELF_STAGE_50_XS

Item No.: 50007100402

[LxWxH]: 740 x 428 x 353 mm

weight: 6,5 kg



MATERIAL+COLOR

basic

base: 100,101

shelf: 401, 402

option

all available colors in chapter

MATERIAL+COLOR

depth = 50 cm

3 x U-Bolts (size: L / M / S_164)



useable height = 29 cm

4 x U-Bolts (size: S)



useable height = 29 cm

2 x U-Bolts (size: XS)



useable height = 29 cm

SHELF_LOW_STAGE_80

SHELF_LOW_STAGE_80_L

Item No.: 80068100402

[LxWxH]: 1950 x 740 x 50 mm

weight: 24,9 kg

SHELF_LOW_STAGE_80_M

Item No.: 80069100402

[LxWxH]: 1790 x 740 x 50 mm

weight: 22,8 kg

SHELF_LOW_STAGE_80_S_164

Item No.: 80070100402

[LxWxH]: 1630 x 740 x 50 mm

weight: 21,0 kg

SHELF_LOW_STAGE_80_S

Item No.: 80071100402

[LxWxH]: 1590 x 740 x 50 mm

weight: 20,4 kg

SHELF_LOW_STAGE_80_XS

Item No.: 80064402

[LxWxH]: 790 x 740 x 10 mm

weight: 8,3 kg

size: L / M / S_164 / S

underside always with metal strut (top view)



size: L / M / S_164 / S

underside always with metal strut (bottom view)



size: XS

underside always without metal strut (both sides look the same)



MATERIAL+COLOR

basic

base: 100

shelf: 401, 402

option

all available colors in chapter

MATERIAL+COLOR

SHELF_LOW_STAGE_50

SHELF_LOW_STAGE_50_L

Item No.: 50032100402

[LxWxH]: 1950 x 440 x 50 mm

weight: 15,0 kg

SHELF_LOW_STAGE_50_M

Item No.: 50033100402

[LxWxH]: 1790 x 440 x 50 mm

weight: 14,1 kg

SHELF_LOW_STAGE_50_S_164

Item No.: 50034100402

[LxWxH]: 1630 x 440 x 50 mm

weight: 11,0 kg

SHELF_LOW_STAGE_50_S

Item No.: 50035100402

[LxWxH]: 1590 x 440 x 50 mm

weight: 10,0 kg

SHELF_LOW_STAGE_50_XS

Item No.: 50026402

[LxWxH]: 790 x 440 x 10 mm

weight: 5,1 kg

size: L / M / S_164 / S

underside always with metal strut (top view)



size: L / M / S_164 / S

underside always with metal strut (bottom view)



size: XS

underside always without metal strut (both sides look the same)



MATERIAL+COLOR

basic

base: 100

shelf: 401, 402

option

all available colors in chapter

MATERIAL+COLOR

Heat Bridge

sneeze guard with heating and LED illumination



HEATBRIDGE_BEER | complete solution with sneeze guard, heating and LED illumination

Item No.: 66002100

[LxWxH]: 1800 x 500 x 440 mm
weight: 20 kg

Base (feet)

steel, powder-coated anthracite
profile 50 x 25 mm

Heating element (infrared technic)

Beer (manufacturer)
model: SOLARIS
power: 5 x 300 W / 230V
color/material: steel, powder-coated
anthracite

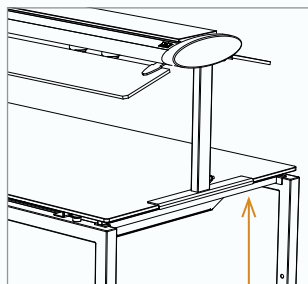

special feet – perfect
connection to the table

+ heavy load strut – additional item to
stabilize the table-top (see page 222)

front view



side view



HEAT + LED

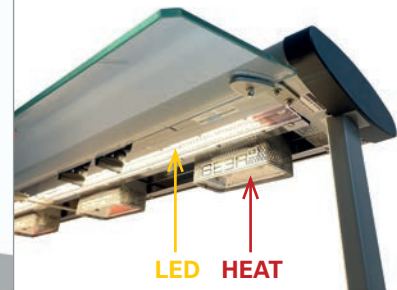
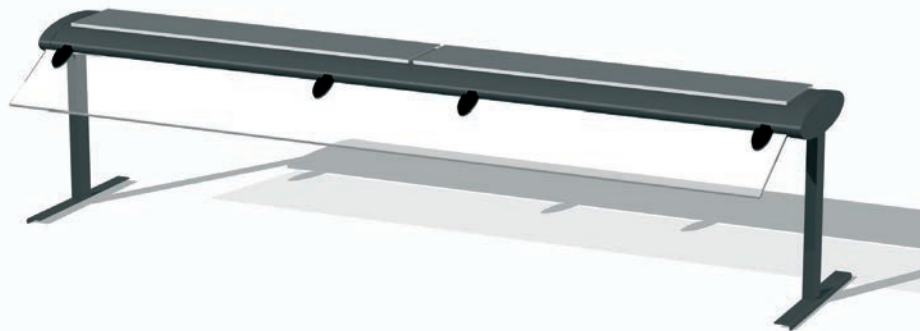

- > sneeze guard (available with one or two side protections)
- > length: 196 cm (STAGE_L), 180 cm (STAGE_M), 162 cm (STAGE_S_164 and STAGE_S), 80 cm (STAGE_XS)

MATERIAL+COLOR

basic
base: 100,101

option
all available colors in chapter MATERIAL+COLOR



combination with STAGE table

SNEEZEGUARD_BEER | solution with sneeze guard and LED illumination (no heating)

Item No.: 66026100

[LxWxH]: 1800 x 500 x 440 mm
weight: 20 kg

Base (feet)

steel, powder-coated anthracite
profile 50 x 25 mm

LED illumination

Beer (manufacturer)
model: SOLARIS
power: 230V

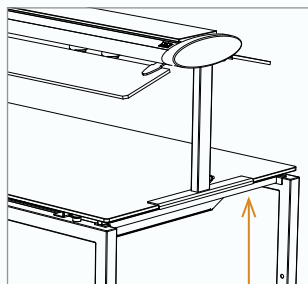

special feet – perfect
connection to the table

+ heavy load strut – additional item to
stabilize the table-top (see page 222)

front view



side view



only LED

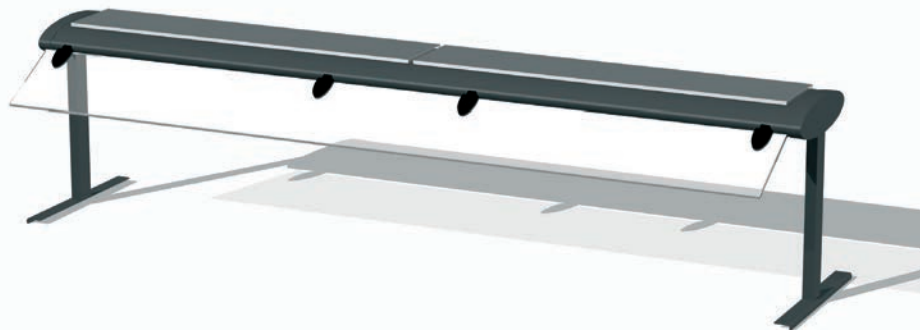

- > sneeze guard (available with one or two side protections)
- > length: 196 cm (STAGE_L), 180 cm (STAGE_M), 162 cm (STAGE_S_164 and STAGE_S), 80 cm (STAGE_XS)

MATERIAL+COLOR

basic
base: 100,101

option
all available colors in chapter MATERIAL+COLOR



combination with STAGE table

Heat Bridge

useful items to complete your tables



HEATBRIDGE_BARTSCHER_180

Item No.: 66004100

[LxWxH]: 1845 x 360 x 445 mm
weight: 8,2 kg

Base (feet)

steel, powder-coated anthracite (100)
profile 15 x 15 mm

Heating element (infrared technic)

model: IHR 1730 / item-no.: 114006
power: 1,73 kW, 230V, 50/60 Hz
color/material: silver, satin aluminum

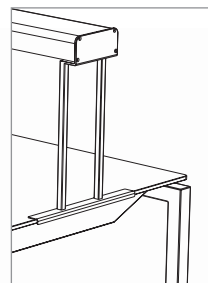

special feet – perfect connection to the table

front view



side view



additional item to keep
the food warm

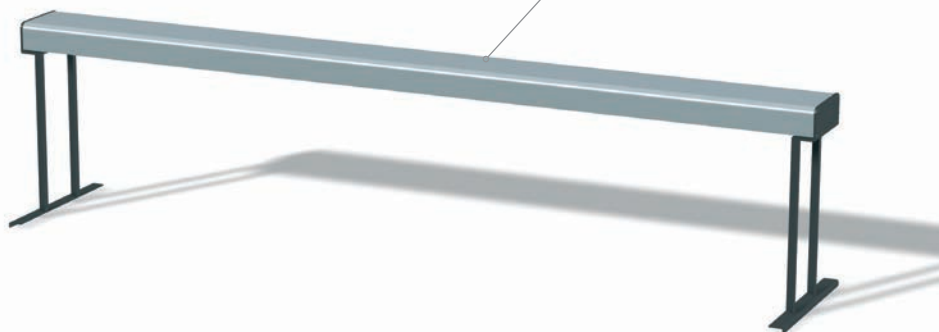

underside view:
infrared heat technic

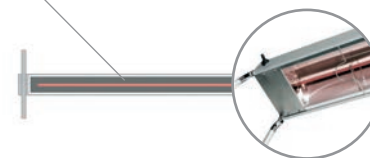

MATERIAL+COLOR

basic
base: 100,101

option
all available colors in chapter MATERIAL+COLOR



combination with STAGE table

HEATBRIDGE_BARTSCHER_80

Item No.: 66032100

[LxWxH]: 804 x 360 x 445 mm
weight: 5,3 kg

Base (feet)

steel, powder-coated anthracite (100)
profile 15 x 15 mm

Heating element (infrared technic)

model: IHR 650 / item-no.: 114001
power: 0,8 kW, 230V, 50/60 Hz
color/material: silver, satin aluminum

**additional item to keep
the food warm**

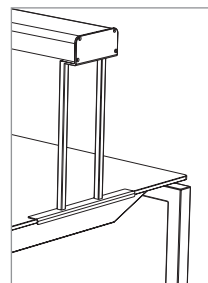
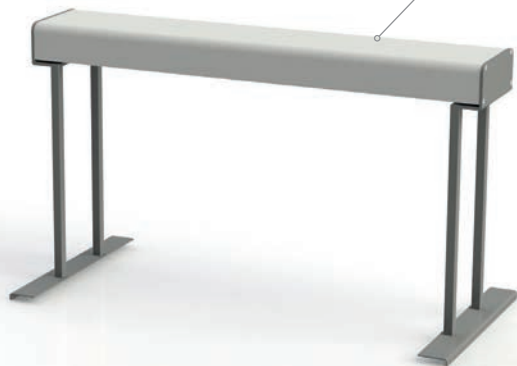

special feet – perfect connection to the table

front view



side view



underside view:
infrared heat technic

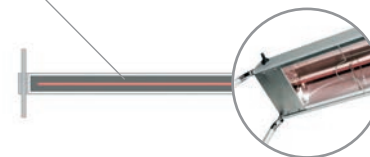

cable length:
140 cm,
only with EU-plug

MATERIAL+COLOR

basic
base: 100,101

option
all available colors in chapter MATERIAL+COLOR

HEAT LAMP STAY HOT

Keep your buffet warm with heat from the top

The Stayhot heat lamp can be installed on every VENTA STAGE table (front-or backside) with a special clamp which is only available at VENTA. The regular Stayhot clamp does not fit onto the VENTA table!



Height: 635 mm
Shade: H 218 / d = 180 mm
Table Clamp: 95 x 60 x 78 mm
Voltage/Power: 230 V / 250 W
Heat Source: Philips infrared lamp 2700K

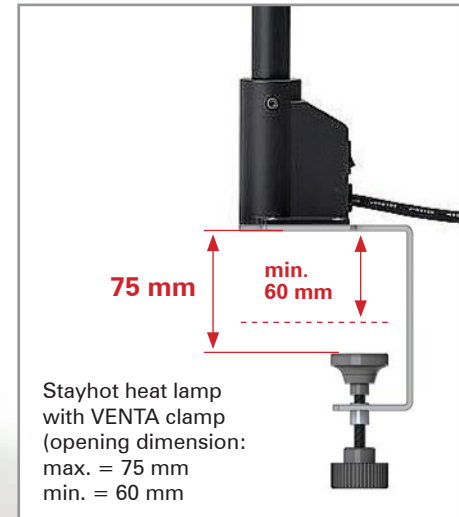

HEAT LAMP STAY HOT | color range



HEAT LAMP STAY HOT | placing + mounting on STAGE tables

If you want to mount the STAY HOT lamps on a table with a compact laminate or glass top, you need to position the lamps over the metal connectors to achieve a perfect fixation.

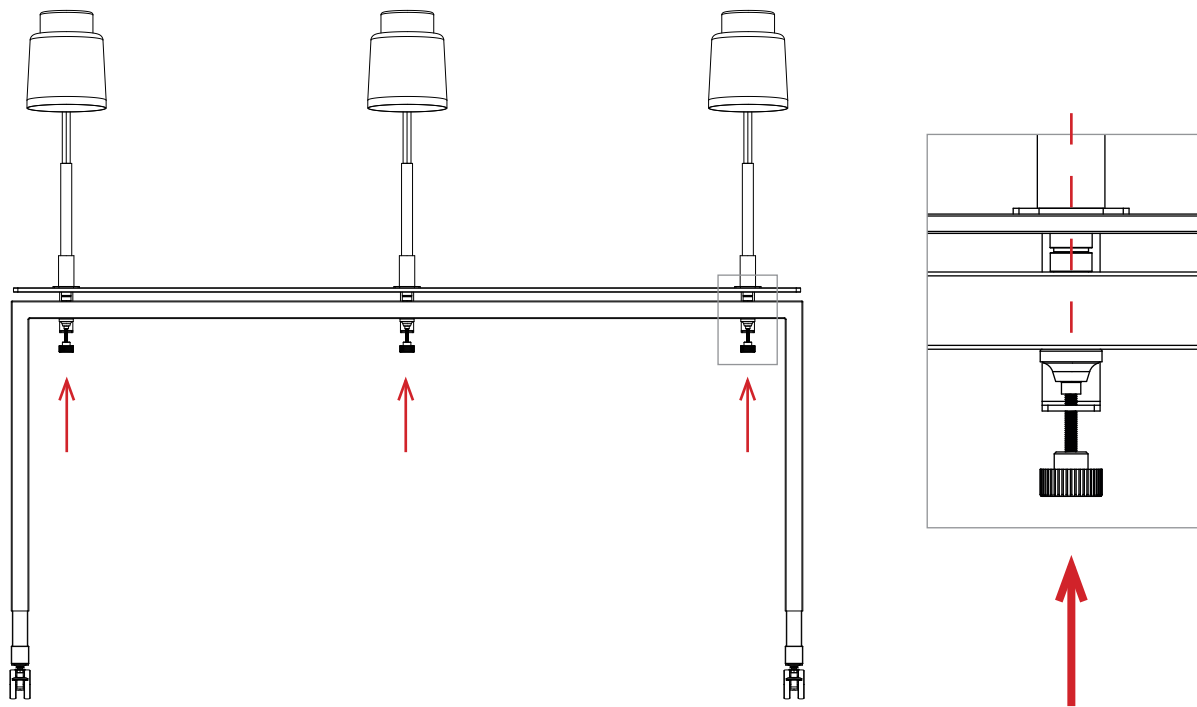

HEAT LAMP STAY HOT | front mounting on STAGE tables | suitable BLINDS

**Front mounting (guest side) of a STAY HOT lamp is also possible (placed at the connector position).
Please notice: The BLIND is only implementable in material COMPACT LAMINATE, no metal blinds!**



No metal blinds!

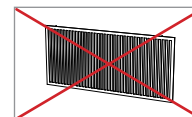
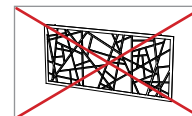
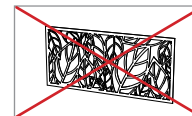

>>> various decors available

HEAT LAMP STAY HOT | placing + mounting on STAGE tables

Alternative positioning of STAY HOT lamps: Please use additional strut to stabilize the table-top.

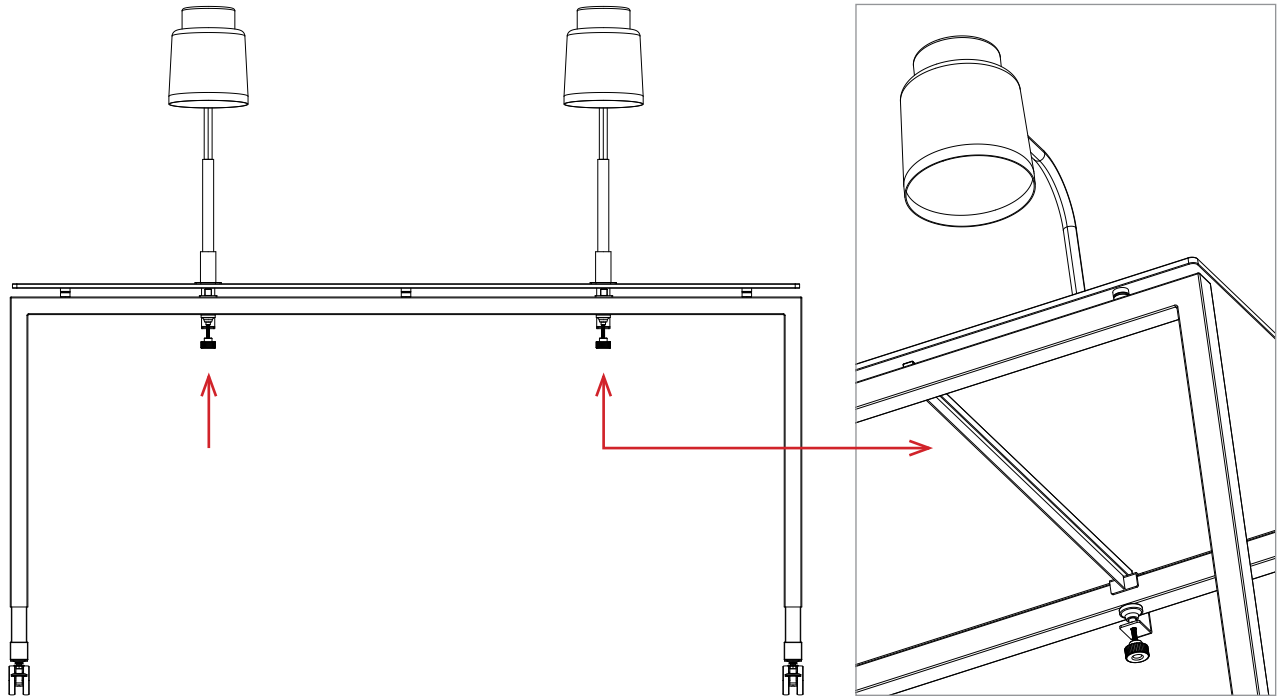

HEAT LAMP STAY HOT | cable management

Depending on the number of STAY HOT lamps installed, please select the suitable extension cables, plugbars and cable ducts.

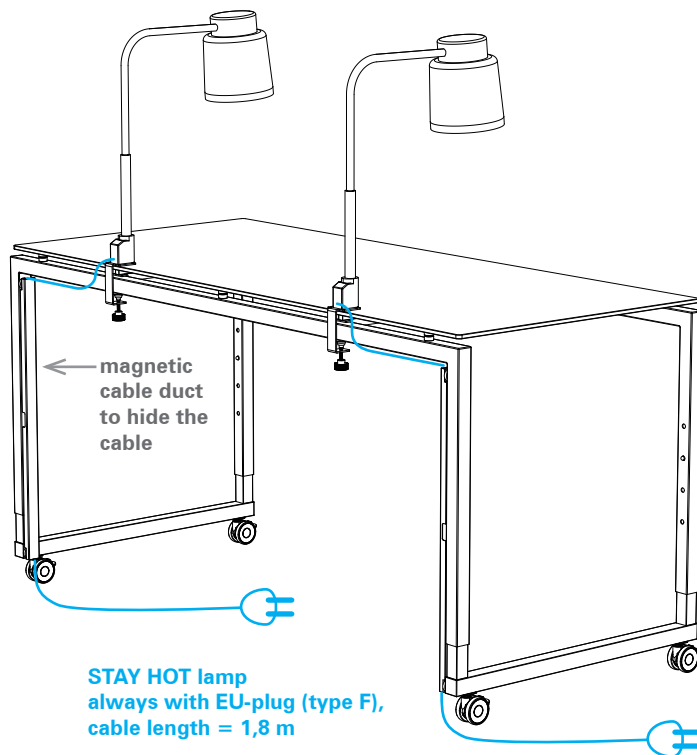

magnetic cable duct (details on page 224)
available in length: 400 mm, 610 mm, 770 mm



extension cable (details on page 227)
available with plug (type F, G, J, I, M)
cable length = 5 m



magnetic plugbar (details on page 227)
available with plug (type F, G, J, I, M)
cable length = 5 m



Sneeze Guard

one or double side



SNEEZEGUARD

Sneeze-guard suitable for all STAGE tables

The new sneeze-guard is available as one side or double side version. Protect your buffet and offers a second level for decoration items.

Double Side:

L: 1960 x 654 x 385 mm (66059)
M: 1800 x 654 x 385 mm (66061)
S_164: 1640 x 654 x 385 mm (66063)
S: 1600 x 654 x 385 mm (66065)
XS: 800 x 654 x 385 mm (66067)

One Side:

L: 1960 x 654 x 385 mm (66058)
M: 1800 x 654 x 385 mm (66060)
S_164: 1640 x 654 x 385 mm (66062)
S: 1600 x 654 x 385 mm (66064)
XS: 800 x 654 x 385 mm (66066)

Base

steel, powder-coated anthracite (100)
profile 15 x 15 mm

Top and Side

transparent, safety glass, 6 mm

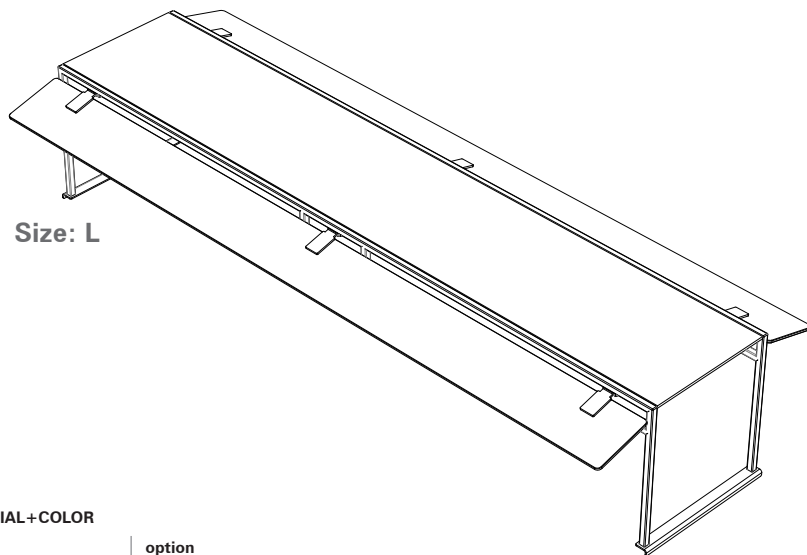

Size: L

MATERIAL+COLOR

basic

base: 100, 101
glass top/side: 300

option

all available colors in chapter
MATERIAL+COLOR

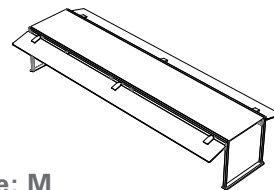

Size: M

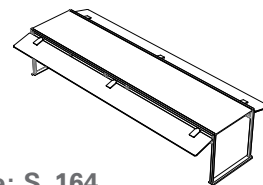

Size: S_164

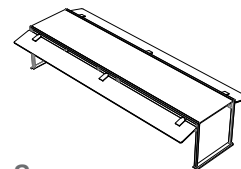

Size: S

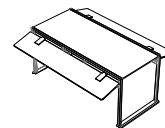

Size: XS



One side Sneeze guard on STAGE_50



SNEEZEGUARD_TRAVERSE

Sneeze-guard suitable for all STAGE tables

The new sneeze-guard protects your buffet and allows to open the lid of the chafing-dish behind.

Overview all models

L: 1960 x 400 x 620 mm (66080)
M: 1800 x 400 x 620 mm (66081)
S_164: 1640 x 400 x 620 mm (66082)
S: 1600 x 400 x 620 mm (66083)
XS: 800 x 400 x 620 mm (66084)

Base

steel, powder-coated anthracite (100)
bended profile 40 x 3 mm

Glass panel

transparent, safety glass, 8 mm

The length of the sneeze-guard corresponds to the length of the table.

The angular shape of the feet guarantees a safe stand on the table-top. The bottom of the feet is covered with felt so that the sneeze-guard can be quickly pushed back and forth on the table-top.

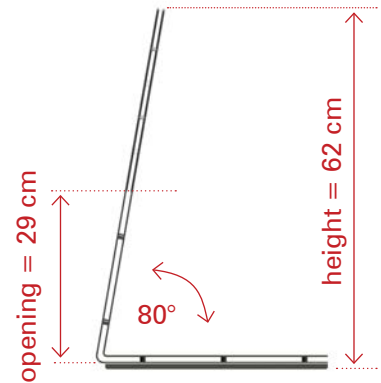

Size: L

MATERIAL+COLOR

basic

base: 100, 101
glass panel: 300

option

all available colors in chapter
MATERIAL+COLOR

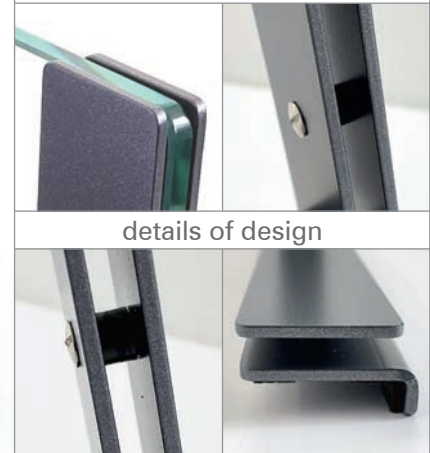

details of design

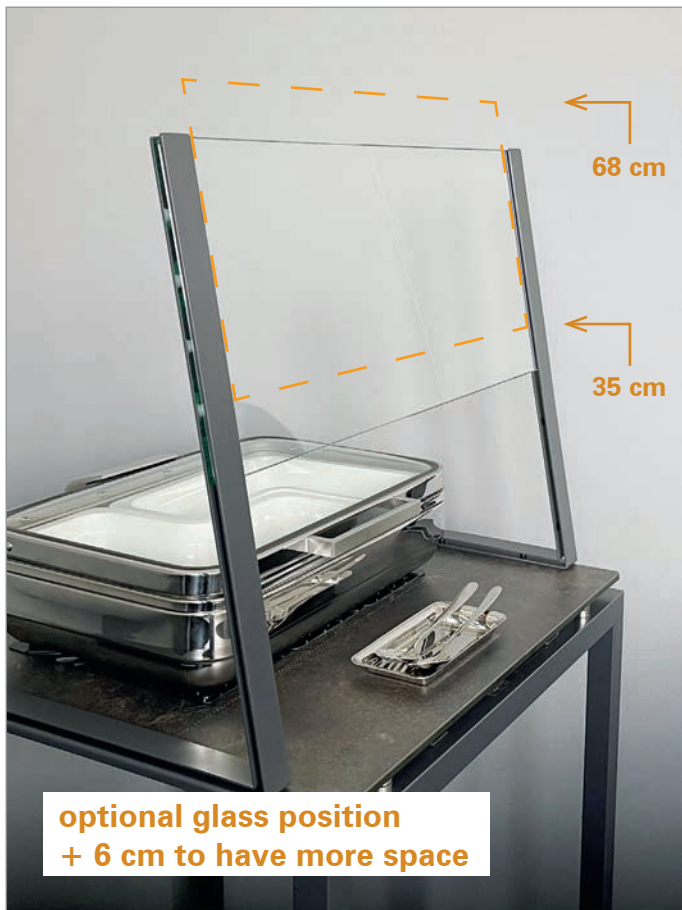

Frontshield

transparent acrylic shields to protect your buffet



Frontshield and heat lamp (mounted at the front side) only work with BLINDS in material compact laminate.

FRONTSHIELD

protect your VENTA buffet with transparent acrylic shields

The new sneezeguard is available as one side or double side version. Protect your buffet and offers a second level for decoration items.

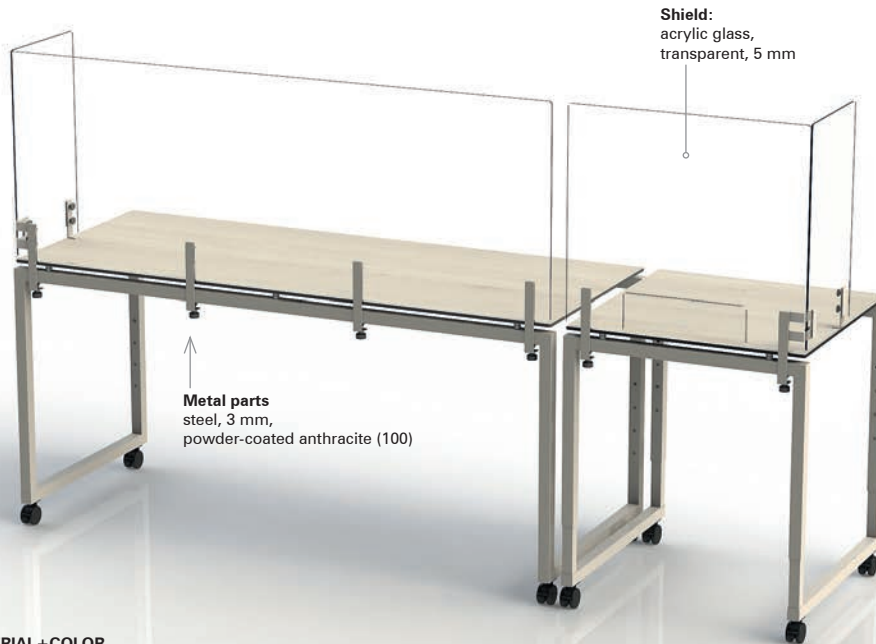

MATERIAL+COLOR

basic
metal parts: 100, 101
shield: 500

option
all available colors in chapter
MATERIAL+COLOR

application:

Mount the transparent acrylic glass to your VENTA table and be protected from the corona virus by preventing the guests from touching food and dishes.

A service employee behind the table arranges the guest's selection on a plate and serves the plate through the service gantry. Every FRONTSHIELD can be mounted with special clamps on the table base frame.

The SIDESHIELD will be mounted on an already installed FRONTSHIELD. The material of the clamps is stainless steel with powder coating according to the color of the base frame. The shield itself is made in transparent acrylic glass.

FRONTSHIELD

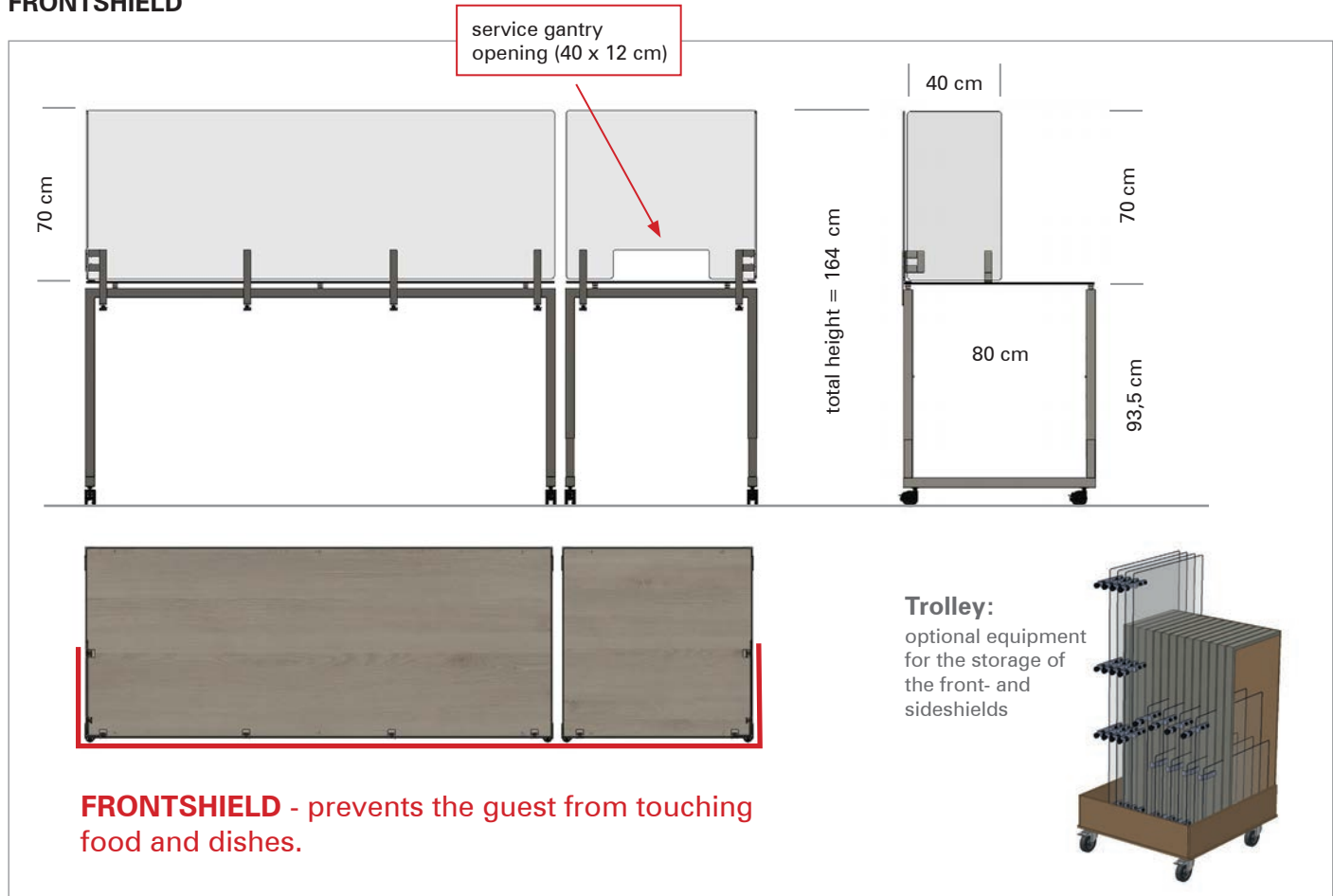

FRONTSHIELD

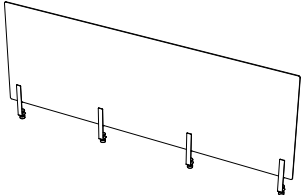
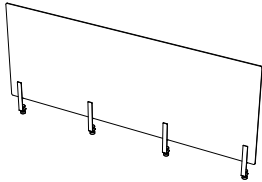
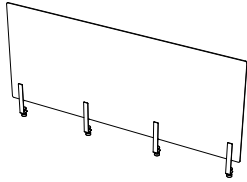
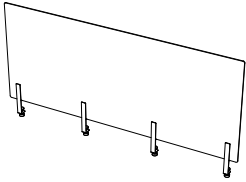
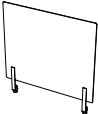
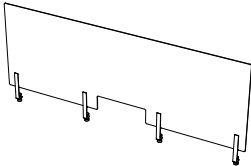
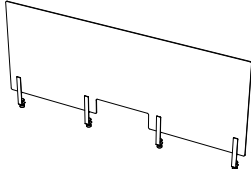
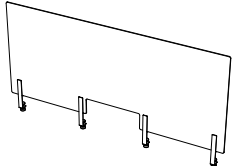
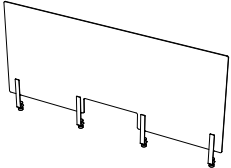
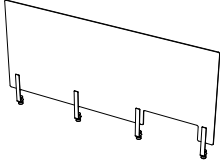
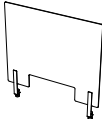
<p>FRONTSHIELD_STAGE_L_70 Item No.: 66043 [LxWxH]: 1950 x 43 x 820 mm</p> 	<p>FRONTSHIELD_STAGE_M_70 Item No.: 66044 [LxWxH]: 1790 x 43 x 820 mm</p> 	<p>FRONTSHIELD_STAGE_S_164_70 Item No.: 66045 [LxWxH]: 1630 x 43 x 820 mm</p> 	<p>FRONTSHIELD_STAGE_S_70 Item No.: 66046 [LxWxH]: 1590 x 43 x 820 mm</p> 
<p>FRONTSHIELD_STAGE_XS_70 Item No.: 66047 [LxWxH]: 790 x 43 x 820 mm</p> 	<p>FRONTSHIELD_APERTURE_STAGE_L_70 Item No.: 66049 [LxWxH]: 1950 x 43 x 820 mm</p> 	<p>FRONTSHIELD_APERTURE_STAGE_M_70 Item No.: 66050 [LxWxH]: 1790 x 43 x 820 mm</p> 	<p>FRONTSHIELD_AP_STAGE_S_164_70 Item No.: 66051 [LxWxH]: 1630 x 43 x 820 mm</p> 
<p>FRONTSHIELD_APERTURE_STAGE_S_70 Item No.: 66052 [LxWxH]: 1590 x 43 x 820 mm</p> 	<p>FRONTSHIELD_SIDE_AP_STAGE_S_70 Item No.: 66053 [LxWxH]: 1590 x 43 x 820 mm</p> 	<p>FRONTSHIELD_APERTURE_STAGE_XS_70 Item No.: 66055 [LxWxH]: 790 x 43 x 820 mm</p> 	<p>All FRONTSHIELD work only with BLINDS in material COMPACT LAMINATE.</p> <p>No metal blinds possible!</p>

SIDESHIELDS

The picture shows the right SIDESHIELD (view from the backside).

It is also possible to mount the metal parts on the other side and create the left SIDESHIELD.

Version to cover the half side of the depth of 80 cm table.



SIDESHIELD_STAGE_39_70
Item No.: 66048
[LxWxH]: 390 x 43 x 820 mm

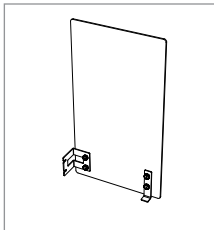

SIDESHIELD_STAGE_48_70
Item No.: 66057
[LxWxH]: 480 x 43 x 820 mm

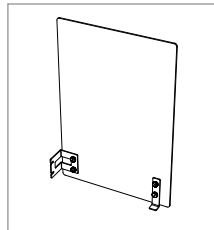

The picture shows the right SIDESHIELD (view from the backside).

It is also possible to mount the metal parts on the other side and create the left SIDESHIELD.

Version to cover the complete depth of 50 cm table.



Both versions can only be mounted on an already installed FRONTSHIELD.

STAGE_ETAGERE | set of 4

Item No.: 32001100300

L: 750 x 400 x 280 mm

M: 700 x 360 x 255 mm

XS: 320 x 320 x 230 mm (two pieces)

total weight: 18,5 kg

Base

steel, powder-coated anthracite

profile 15 x 15 mm,

weight: 1,4 kg/1,3 kg/2 x 0,6 kg

Table-top

safety glass 6 mm,

weight: 4,4 kg/3,7 kg/2 x 1,5 kg

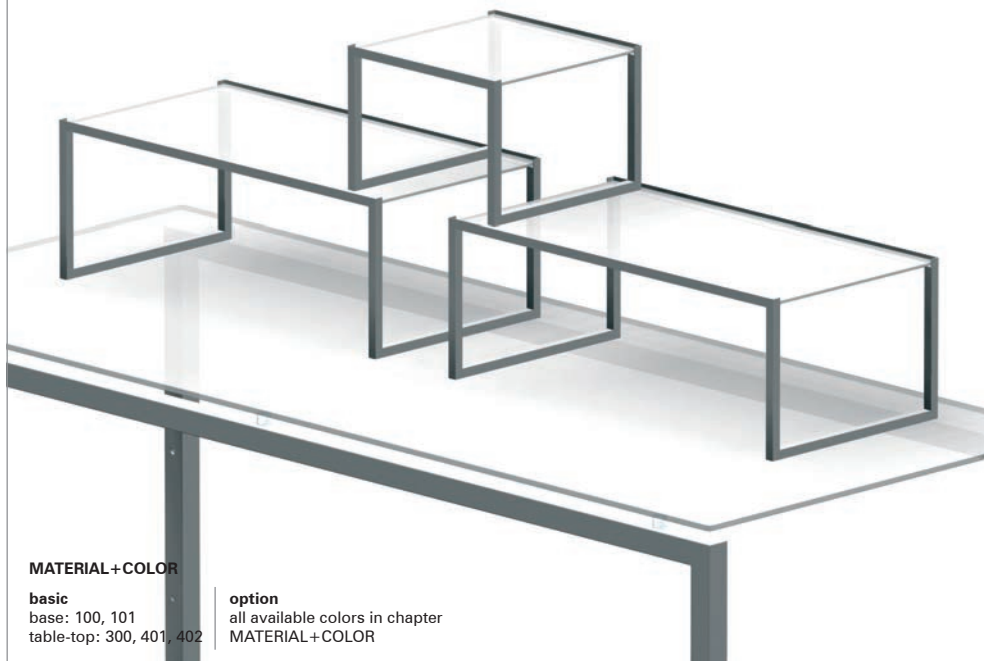

MATERIAL+COLOR

basic

base: 100, 101

table-top: 300, 401, 402

option

all available colors in chapter

MATERIAL+COLOR

front view



side view



top view



set of four pieces



stackable for storage





Radicchio

STAGE_ETAGERE_COOL_SQ

Item No.: 32005100303

[LxWxH]: 400 x 400 x 150 mm
weight: 7,0 kg

Base

steel, powder-coated anthracite
profile 15 x 15 mm
weight: 7 kg

Table-top

safety glass 6 mm, white glass,
underside white colored,
weight: 2,2 kg

>>> also available as rectangular
model [size: 850 x 420 x 200 mm]
with 2 x COOL_PLATES inside
Item No.: 32006

Bowl (for COOL_PLATES)

steel, 1 mm, bended, powder-coated
weight: 1,5 kg

COOL_PLATE

350 x 350 x 25 mm
polystyrol, black
weight: 2,4 kg

2h cooling
5°-10°C
on the glass surface
without electricity

works only with
glass surface

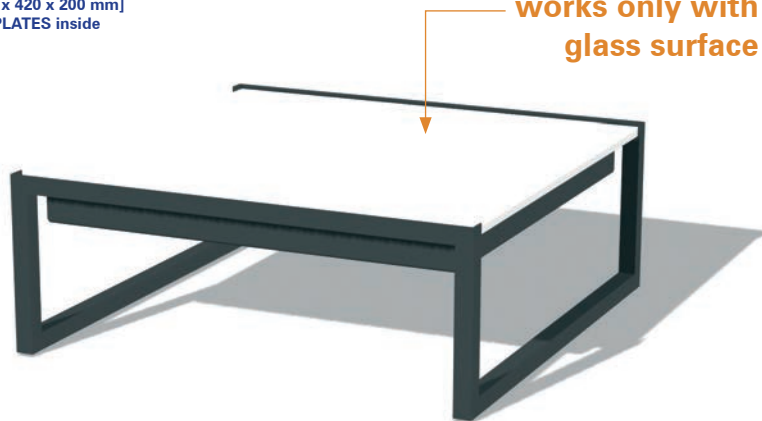

MATERIAL+COLOR

basic

base: 100, 101
table-top: 303, 307

option

all available colors in chapter
MATERIAL+COLOR

66003 / COOL_PLATE

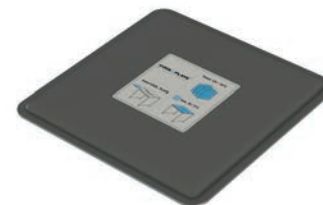

explosion view / main parts



99129 / Trolley_COOL_PLATES_8





Plate Warmer

perfectly integrated in the buffet line



STAGE_50_XS_PLATE_STATION_KIT_RRV-H1

Item No.: 51027100402402

[LxWxH]: 800 x 500 x 935 mm
weight: 31 kg

Base

steel, powder-coated anthracite
profile 40 x 40 mm,
weight: 12,6 kg

Table-top

compact panel 10 mm,
790 x 490 mm,
weight: 5,6 kg

Mounting frame

steel, powder-coated anthracite
profile 40 x 40 mm
weight: 4 kg

FRONT- and SIDEBLINDS

compact panel: 3 mm
decor: ceramic anthracite
weight: 8,8 kg

Individual

other colors on request



warm plates
in a STAGE_50_XS

MATERIAL+COLOR

basic

base: 100,101
table-top: 401, 402

option

all available colors in chapter
MATERIAL+COLOR

explosion view/delivery contents

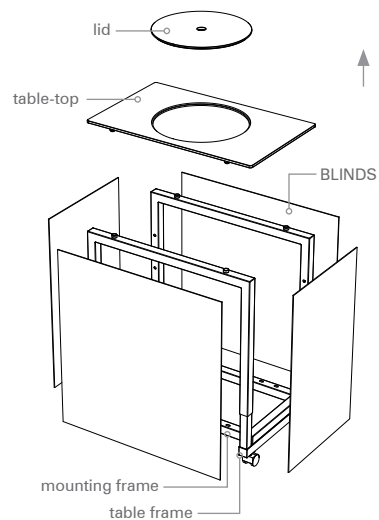

separate item/not included

Item No.: 11039



RIEBER plater warmer (model: RRV-H1)

STAGE_50_XS_PS_KIT | PANEL OPTIONS

Item No.: 51028402

[LxWxH]: 800 x 500 x 935 mm
weight: 22,2 kg

Base

steel, powder-coated anthracite
profile 40 x 40 mm,
weight: 12,6 kg

Table-top + Lid

compact panel 10 mm,
790 x 490 mm,
weight: 5,6 kg

Mounting frame

steel, powder-coated anthracite
profile 40 x 40 mm
weight: 4 kg

Individual

other colors on request

**KIT without panels
you have to add them
with your order**



MATERIAL+COLOR

basic

base: 100,101
table-top: 401, 402

option

all available colors in chapter
MATERIAL+COLOR

explosion view/delivery contents

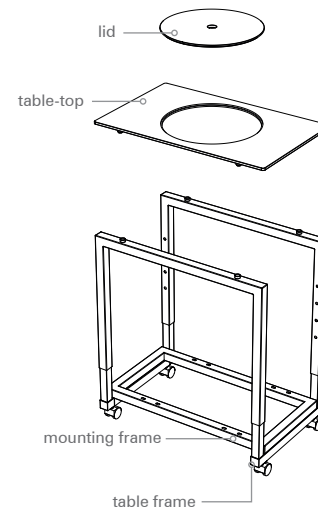

separate item/not included

Item No.: 11039



RIEBER plater warmer (model: RRV-H1)

Special Buffet Furniture

Service-Cart | Column Table | Corner Table



STAGE_50_XS_SERVICE-CART

Item No.: 51041101401401
[LxWxH]: 800 x 500 x 935 mm
total weight: 32,5 kg

Base
2 x main frame 6,6 kg
2 x table leg 5,0 kg
steel, powder-coated anthracite (100)
profile 40 x 40 mm, with height
compensation

4 x Castor
diameter = 65 mm
weight: 0,5 kg

Height adjustable:
775 mm (lowest height)
855, 935, 1015 mm

Table-top
compact laminate 10 mm,
premium white (401)
weight: 8,8 kg

SHELF_STAGE_50_XS
Item No.: 50007100401
[LxWxH]: 740 x 428 x 353 mm
weight: 6,5 kg

SHELF_LOW_STAGE_50_XS
Item No.: 50026401
[LxWxH]: 790 x 440 x 10 mm
weight: 5,1 kg

Additional equipment
(please order separately)
blinds in metal with decor cut-outs
(BAMBOO, LEAF, STRIPES design) or
in compact panel (thickness of 3 mm),
decor: e.g. ceramic anthracite and
many more options



MATERIAL+COLOR

basic
base: 100,101
table-top: 401, 402
shelf: 401, 402

option
all available colors in chapter
MATERIAL+COLOR

The small buffet table
STAGE_50_XS and two
additional shelves result in
a new product: the VENTA
SERVICE-CART.

This very useful table
offers a wide range of
applications.

Small ordering table for
serving, as a small tea
trolley for meetings or sim-
ply equipped with a blind as
practical storage space.

QUAD_230 (set of 2 items)

Item No.: 28001100300

QUAD_230

[LxWxH]: 1600 x 700 x 900 mm
weight: 32 kg

Base

steel, powder-coated anthracite
profile 30 x 30 mm, not foldable
weight: 10 kg

Table-top

safety glass 10 mm,
to be fixed to the base,
weight: 22 kg

QUAD_ETAGERE_160

[LxWxH]: 1100 x 350 x 260 mm
weight: 11,3 kg

4 x Feet

stainless steel, matt abraded
weight: 4 x 0,7 kg = 2,8 kg

Table-top

safety glass 10 mm,
bolted with the feet,
weight: 8,5 kg

Top View

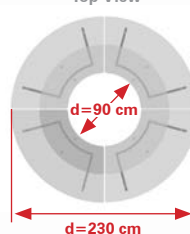

4 x QUAD
around a column
($\varnothing=230$ cm)

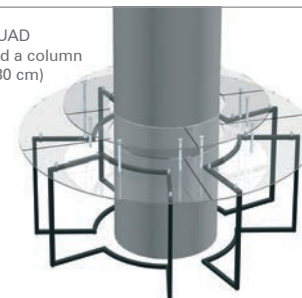

compilation of
4 x QUAD and
4 x SCAPE



The „ALL-ROUNDER“
placed in a circle, around a
column or in combination
with the SCAPE model.



MATERIAL+COLOR

basic

base: 100,101
table-top: 300, 401, 402

option

all available colors in chapter
MATERIAL+COLOR

Item No.: 99135

Trolley for 4 x QUAD



weight: 67 kg [empty]/240 kg [full]

TABLE_RACK

Item No.: 32010100402

[LxWxH]: 762 x 430 x 800 mm
total weight: 18,3 kg

Base

material: steel, powder-coated,
profile 15 x 15 mm, anthracite (100)
weight: 6,0 kg

Shelf

material: compact laminate 10 mm
decor: ceramic anthracite (402)
dimension: 743 x 395 mm
weight: 4,1 kg

Shelf (alternate material)

material: glass, 6 mm
dimension: 743 x 395 mm
weight: 4,3 kg

OPTIONAL EQUIPMENT

modification set for TABLE RACK
Item No.: 32017

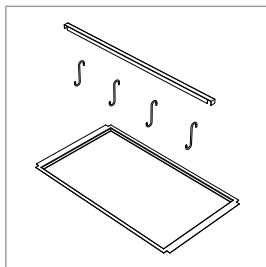

MATERIAL+COLOR

basic

base: 100,101
table-top: 300, 401, 402

option

all available colors in chapter
MATERIAL+COLOR



grid of 5 cm to install
the shelves at different
heights suitable for
your purposes



DUCK_STATION

Item No.: 32011100199

[LxWxH]: 762 x 430 x 800 mm
total weight: 8,4 kg

Base

material: steel, powder-coated,
profile 15 x 15 mm, anthracite (100)
weight: 5,3 kg

Upper cross bar

material: stainless steel
dimension: 765 x 16 x 17 mm
weight: 0,3 kg

Tray

material: stainless steel
dimension: 762 x 430 x 16 mm
weight: 2,76 kg

OPTIONAL EQUIPMENT

modification set for DUCK STATION
Item No.: 32018

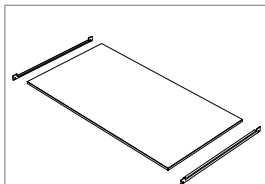

Please choose the number of
shelves for your purpose.

MATERIAL+COLOR

basic

base: 100,101
+ stainless steel (199)

option

all available colors in chapter
MATERIAL+COLOR

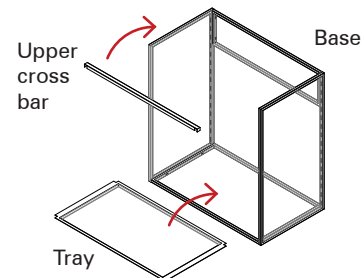

including 4 x meat hook (100 mm)



STAGE_80_XS_45_RO

Item No.: 81114101412

[LxWxH]: 800 x 770 x 775 mm

height adjustable: 855, 935, 1015 mm

total weight: 20,3 kg

Base

steel, powder-coated anthracite (101)
profile 40 x 40 mm, with height
compensation

Table-top

compact laminate 10 mm,
white aland pine (412)



MATERIAL+COLOR

basic

base: 100,101

table-top: 401, 402

shelf: 401, 402

option

all available colors in chapter

MATERIAL+COLOR

SHELF_STAGE_80_XS_45_RO

Item No.: 80115

[LxWxH]: 825 x 660 x 350 mm

weight: 6,0 kg

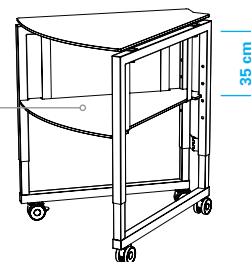

SHELF_47_STAGE_80_XS_45_RO

Item No.: 80116

[LxWxH]: 825 x 660 x 470 mm

weight: 6,4 kg

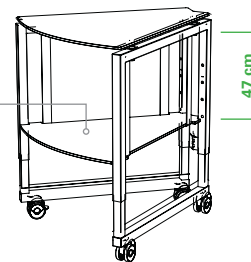

SHELF_LOW_STAGE_80_XS_45_RO

Item No.: 80117

[LxWxH]: 825 x 675 x 10 mm

weight: 5,3 kg

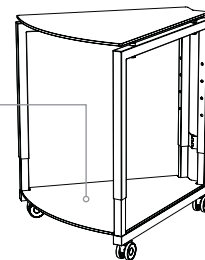

Style your buffet in any shape

The 45° table allows you to create various setups with the rectangular STAGE tables. With the optional shelves you have attractive and functional corner points in your buffet line.

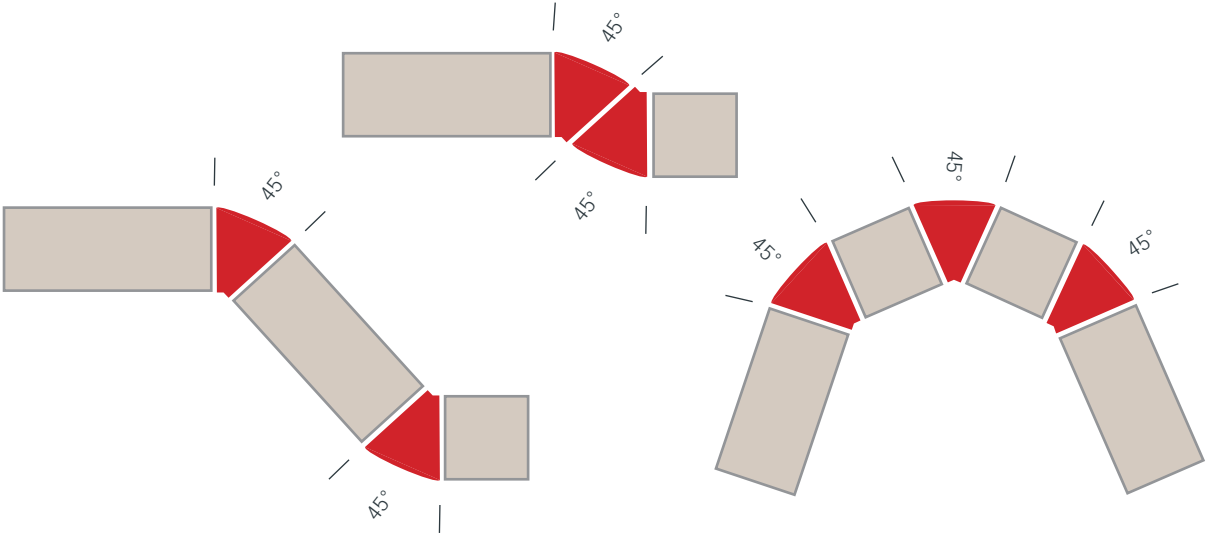

STAGE_80_XS_90_RO

Item No.: 81124101412

[LxWxH]: 900 x 900 x 775 mm

height adjustable: 855, 935, 1015 mm

total weight: 24,7 kg

Base

steel, powder-coated anthracite (101)
profile 40 x 40 mm, with height
compensation

Table-top

compact laminate 10 mm,
white aland pine (412)



MATERIAL+COLOR

basic

base: 100,101

table-top: 401, 402

shelf: 401, 402

option

all available colors in chapter
MATERIAL+COLOR

SHELF_STAGE_80_XS_90_RO

Item No.: 80125

[LxWxH]: 860 x 860 x 370 mm

weight: 9,1 kg

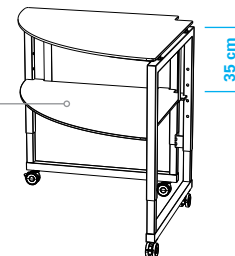

35 cm

SHELF_47_STAGE_80_XS_90_RO

Item No.: 80126

[LxWxH]: 860 x 860 x 490 mm

weight: 9,5 kg

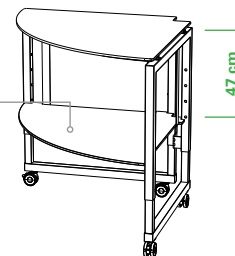

47 cm

SHELF_LOW_STAGE_80_XS_90_RO

Item No.: 80127

[LxWxH]: 880 x 880 x 130 mm

weight: 8,4 kg

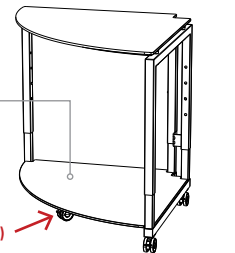

>>> with additional castor (d = 65 mm)
to ensure stability under high load

Style your buffet in any shape

The 90° table allows to create various setups with the rectangular STAGE tables. With the optional shelves you have attractive and functional corner points in your buffet line.

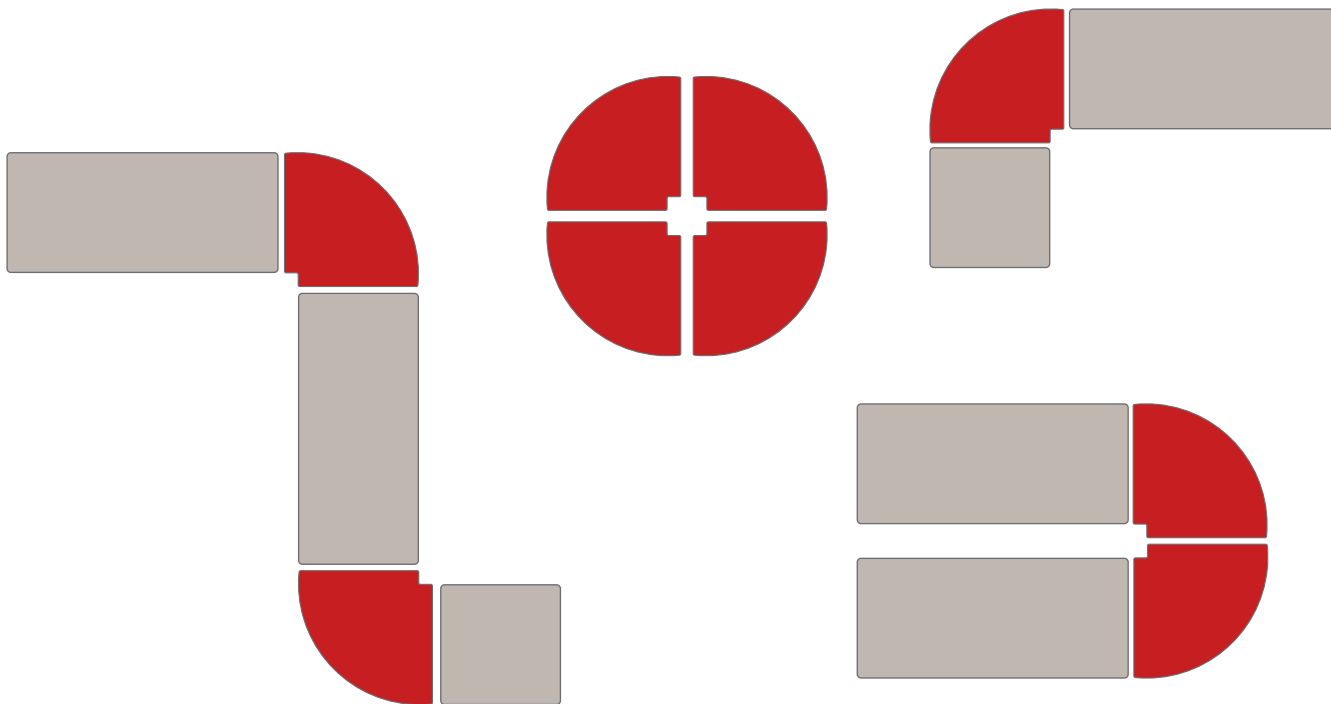

Foldable Buffet Tables

SCAPE | LEVEL



SCAPE_70 | Foldable Table System

- > foldable table base
- > available in 3 heights (75 cm, 90 cm, 105 cm)
- > with or without lower-tray
- > square or round table-top



SCAPE_70 | Foldable Table System



connection from the foot to the table top through a screw (not removable)

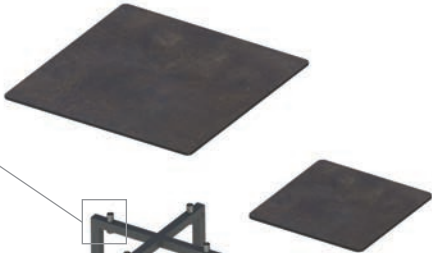

one adjustable foot on the bottom of the base frame



5 x space for table-top (round and square, possible to mix)

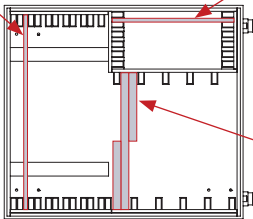

5 x space for lower tray (round and square, possible to mix)

5 x space for base frame (all heights)

Item No.: 99137
 [LxWxH]: 780 x 870 x 670 mm
 weight: 45,0 kg

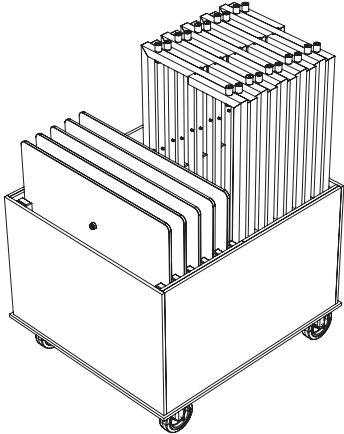

SCAPE_70_SQ_75

Item No.: 24010100402

[LxWxH]: 700 x 700 x 750 mm
total weight: 13,3 kg

Base

foldable base frame without side holder
steel, powder-coated anthracite (100)
profile 30 x 30 mm
weight: 6,3 kg

Table-top

compact panel, 700 x 700 x 10 mm, underside
with 4 x connectors
weight: 7,0 kg



SCAPE_70_SQ_90

Item No.: 24011100402

[LxWxH]: 700 x 700 x 900 mm
total weight: 13,8 kg

Base

foldable base frame without side holder
steel, powder-coated anthracite (100)
profile 30 x 30 mm
weight: 6,8 kg

Table-top

compact panel, 700 x 700 x 10 mm, underside
with 4 x connectors
weight: 7,0 kg



SCAPE_70_SQ_105

Item No.: 24012100402

[LxWxH]: 700 x 700 x 1050 mm
total weight: 14,3 kg

Base

foldable base frame without side holder
steel, powder-coated anthracite (100)
profile 30 x 30 mm
weight: 7,3 kg

Table-top

compact panel, 700 x 700 x 10 mm, underside
with 4 x connectors
weight: 7,0 kg



MATERIAL+COLOR

basic

base: 100, 101
table-top: 300, 401, 402

option

all available colors in chapter
MATERIAL+COLOR

SCAPE_70_RO_75

Item No.: 24019100402

[LxWxH]: 700 x 700 x 750 mm
total weight: 11,8 kg

Base

foldable base frame without side holder
steel, powder-coated anthracite (100)
profile 30 x 30 mm
weight: 6,3 kg

Table-top

compact panel, d = 700mm x 10 mm,
underside with 4 x connectors
weight: 5,5 kg



SCAPE_70_RO_90

Item No.: 24020100402

[LxWxH]: 700 x 700 x 900 mm
total weight: 12,3 kg

Base

foldable base frame without side holder
steel, powder-coated anthracite (100)
profile 30 x 30 mm
weight: 6,8 kg

Table-top

compact panel, d = 700 x 10 mm,
underside with 4 x connectors
weight: 5,5 kg



SCAPE_70_RO_105

Item No.: 24021100402

[LxWxH]: 700 x 700 x 1050 mm
total weight: 12,8 kg

Base

foldable base frame without side holder
steel, powder-coated anthracite (100)
profile 30 x 30 mm
weight: 7,3 kg

Table-top

compact panel, d = 700 x 10 mm,
underside with 4 x connectors
weight: 5,5 kg



MATERIAL+COLOR

basic

base: 100,101
table-top: 300, 401, 402

option

all available colors in chapter
MATERIAL+COLOR

SCAPE_70_SQ_75_T

Item No.: 24022100402

[LxWxH]: 700 x 700 x 750 mm
total weight: 15,9 kg

Base

foldable base frame with side holder
steel, powder-coated anthracite (100)
profile 30 x 30 mm, weight: 6,3 kg

Table-top

compact panel, 700 x 700 x 10 mm, underside with 4 x
connectors, weight: 7,0 kg

Lower-tray

compact panel, 425 x 425 x 10 mm
weight: 2,6 kg



MATERIAL+COLOR

basic

base: 100, 101
table-top: 300, 401, 402

option

all available colors in chapter
MATERIAL+COLOR

SCAPE_70_SQ_90_T

Item No.: 24023100402

[LxWxH]: 700 x 700 x 900 mm
total weight: 16,4 kg

Base

foldable base frame with side holder
steel, powder-coated anthracite (100)
profile 30 x 30 mm, weight: 6,8 kg

Table-top

compact panel, 700 x 700 x 10 mm, underside with 4 x
connectors, weight: 7,0 kg

Lower-tray

compact panel, 425 x 425 x 10 mm
weight: 2,6 kg



SCAPE_70_SQ_105_T

Item No.: 24024100402

[LxWxH]: 700 x 700 x 1050 mm
total weight: 16,9 kg

Base

foldable base frame with side holder
steel, powder-coated anthracite (100)
profile 30 x 30 mm, weight: 7,3 kg

Table-top

compact panel, 700 x 700 x 10 mm, underside with 4 x
connectors, weight: 7,0 kg

Lower-tray

compact panel, 425 x 425 x 10 mm
weight: 2,6 kg



SCAPE_70_RO_75_T

Item No.: 24025100402

[LxWxH]: 700 x 700 x 750 mm
total weight: 13,8 kg

Base

foldable base frame without side holder
steel, powder-coated anthracite (100)
profile 30 x 30 mm, weight: 6,3 kg

Table-top

compact panel, d = 700mm x 10 mm, underside with
4 x connectors, weight: 5,5 kg

Lower-tray

compact panel, d = 425 x 10 mm
weight: 2,0 kg



SCAPE_70_RO_90_T

Item No.: 24026100402

[LxWxH]: 700 x 700 x 900 mm
total weight: 14,3 kg

Base

foldable base frame without side holder
steel, powder-coated anthracite (100)
profile 30 x 30 mm, weight: 6,8 kg

Table-top

compact panel, d = 700 x 10 mm, underside with
4 x connectors, weight: 5,5 kg

Lower-tray

compact panel, d = 425 x 10 mm
weight: 2,0 kg



SCAPE_70_RO_105_T

Item No.: 24027100402

[LxWxH]: 700 x 700 x 1050 mm
total weight: 14,8 kg

Base

foldable base frame without side holder
steel, powder-coated anthracite (100)
profile 30 x 30 mm, weight: 7,3 kg

Table-top

compact panel, d = 700 x 10 mm, underside with
4 x connectors, weight: 5,5 kg

Lower-tray

compact panel, d = 425 x 10 mm
weight: 2,0 kg



MATERIAL+COLOR

basic

base: 100,101
table-top: 300, 401, 402

option

all available colors in chapter
MATERIAL+COLOR

SCAPE_180

Item No.: 24002100402

[LxWxH]: 1800 x 700 x 900 mm
total weight: 30,3 kg

Base

foldable base frame
steel, powder-coated anthracite (100)
profile 30 x 30 mm, weight: 13,3 kg

Table-top

compact panel, 1800 x 700 x 10 mm,
underside with 7 x connectors
weight: 17,0 kg

Height options

table height = 750 mm
table height = 1050 mm

Alternative:

Table-top

safety glass 10 mm,
transparent, white colored, ...
weight: 31 kg



MATERIAL+COLOR

basic

base: 100, 101
table-top: 300, 401, 402

option

all available colors in chapter
MATERIAL+COLOR

connection between table-top and base

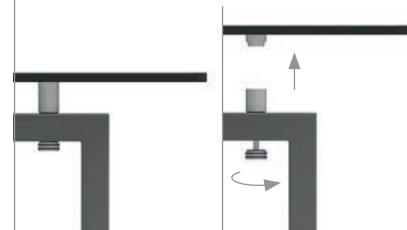

folding-system



Item No.: 99136

Trolley for maximum 5 x SCAPE_180



weight: 72 kg [empty] / 223,5 kg [full]

LEVEL_150 | set of 3 items

Item No.: 26001100402

LEVEL_Table_150

[LxWxH]: 1500 x 750 x 840 mm
weight: 19,0 kg

Base

foldable base frame
steel, powder-coated anthracite (100)
profile 30 x 30 mm, weight: 8,0 kg

Table-top

compact panel, 1800 x 700 x 10 mm,
underside with 3 x connectors
weight: 11,0 kg

LEVEL_ETAGERE_100

[LxWxH]: 1000 x 500 x 260 mm
weight: 7,6 kg

Feet

stainless steel, matt abraded
weight: 3 x 0,7 kg

Table-top

compact panel, 1000 x 500 x 10 mm,
underside with 3 x connectors
weight: 5,5 kg

LEVEL_ETAGERE_60

[LxWxH]: 600 x 300 x 200 mm
weight: 3,5 kg

Feet

stainless steel, matt abraded
weight: 3 x 0,5 kg

Table-top

compact panel, 600 x 300 x 10 mm,
underside with 3 x connectors
weight: 2,0 kg



MATERIAL+COLOR

basic

base: 100,101
table-top: 300, 401, 402

option

all available colors in chapter
MATERIAL+COLOR

connection between table-top and feet



folding-system

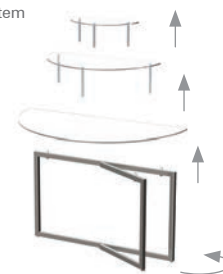

Item No.: 99134

Trolley for max. 4 x LEVEL_150



weight: 77 kg [empty] / 197,4 kg [full]

Cocktail Tables + Bar Area

Cocktail Table | High Table | High Stool | Hospi Desk | Backbar | Side Table | Mobile Bar





SET_70 / versions of material + color



SET_70 | glass top

Item No.: 23001100300300

[LxWxH]: 700 x 700 x 1050 mm
weight: 18,5 kg

Base

steel, powder-coated anthracite
profile 30 x 30 mm, can be folded
weight: 7 kg

Table-top

safety glass 10 mm, $\varnothing = 700$ mm,
to be fixed to the base,
weight: 10 kg

Lower-tray

safety glass 4 mm, $\varnothing = 425$ mm,
weight: 1,5 kg



MATERIAL+COLOR

basic

base: 100,101
table-top: 300
lower-tray: 300

option

all available colors in chapter
MATERIAL+COLOR

Trolley for
SET_70 tables
with table-top
and lower tray
in material
glass.

connection between table-top and base

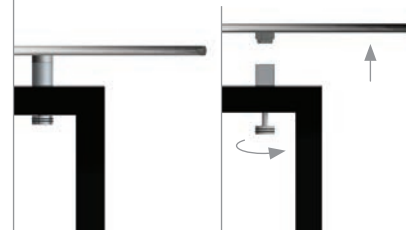

folding-system

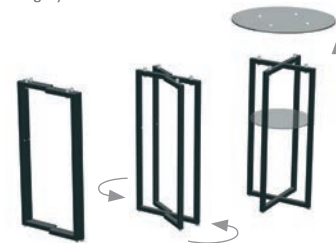

Item No.: 99101

Trolley for 10 x cocktail table_SET_70



weight: 35 kg [empty] / 220 kg [full]

SET_65 | glass top

Item No.: 23004100300300
[LxWxH]: 650 x 650 x 1050 mm
weight: 18,6 kg

Base
steel, powder-coated anthracite
profile 30 x 30 mm, can be folded
weight: 7 kg

Table-top
safety glass 10 mm, 650 x 650 mm,
to be fixed to the base,
weight: 10 kg

Lower-tray
safety glass 4 mm, 425 x 425 mm,
weight: 1,6 kg

The table top
has a size of
650 x 650 mm
to ensure the
stability of the
cocktail table.



MATERIAL+COLOR

basic
base: 100,101
table-top: 300
lower-tray: 300

option
all available colors in chapter
MATERIAL+COLOR

Trolley for
SET_65 tables
with table-top
and lower tray
in material
glass.

connection between table-top and base

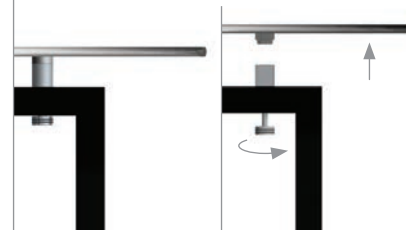

folding-system

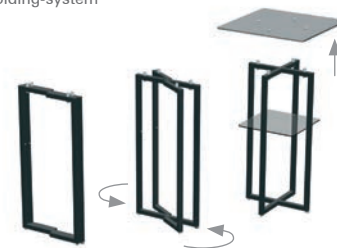

Item No.: 99103
Trolley for 10 x cocktail table_SET_65

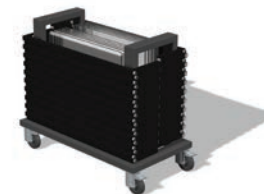

weight: 35 kg [empty] / 221 kg [full]

SET_70 | compact laminate

Item No.: 23001100402402

[LxWxH]: 700 x 700 x 1050 mm
weight: 14,0 kg

Base

steel, powder-coated anthracite
profile 30 x 30 mm, can be folded
weight: 7 kg

Table-top

safety glass 10 mm, $\phi = 700$ mm,
to be fixed to the base,
weight: 10 kg

Lower-tray

compact laminate 10 mm,
 $\phi = 425$ mm,
weight: 1,5 kg



MATERIAL+COLOR

basic

base: 100,101
table-top: 402
lower-tray: 402

option

all available colors in chapter
MATERIAL+COLOR

connection between table-top and base

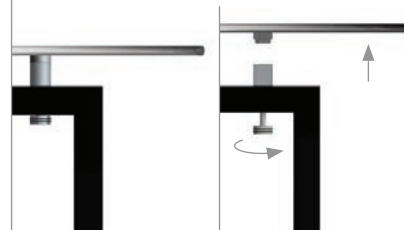

folding-system

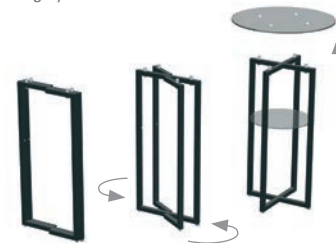

Item No.: 99102

Trolley for 10 x cocktail table_SET_70

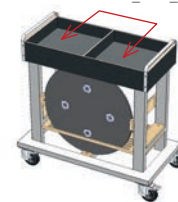

>>>each
compartment
can take 5 x
lower-tray

This special
trolley is neces-
sary for SET_70
with lower-tray
in material com-
pact laminate.

weight: 35 kg [empty] / 221 kg [full]

SET_65 | compact laminate

Item No.: 23004100402402

[LxWxH]: 650 x 650 x 1050 mm
weight: 14,6 kg

Base

steel, powder-coated anthracite
profile 30 x 30 mm, can be folded
weight: 7 kg

Table-top

safety glass 10 mm, 650 x 650 mm,
to be fixed to the base,
weight: 10 kg

Lower-tray

compact laminate 10 mm,
425 x 425 mm,
weight: 1,5 kg

The table top
has a size of
650 x 650 mm
to ensure the
stability of the
cocktail table.



MATERIAL+COLOR

basic

base: 100,101
table-top: 402
lower-tray: 402

option

all available colors in chapter
MATERIAL+COLOR

connection between table-top and base

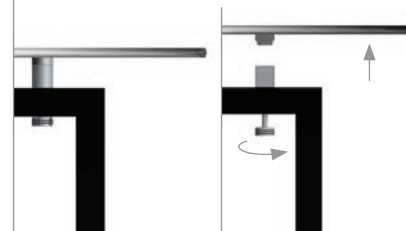

folding-system

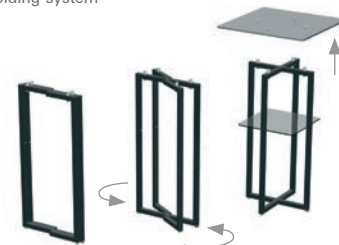

Item No.: 99104

Trolley for 10 x cocktail table_SET_65

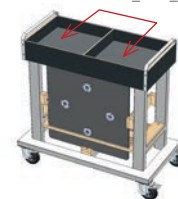

>>>each
compartment
can take 5 x
lower-tray

This special
trolley is neces-
sary for SET_65
with lower-tray
in material com-
pact laminate.

weight: 35 kg [empty] / 221 kg [full]

LED Frame

illuminate your cocktail table



SET_70_LED

Item No.: 23007100303

[LxWxH]: 700 x 700 x 1050 mm
weight: 20 kg

Base

steel, powder-coated anthracite
profile 30 x 30 mm, can be folded
weight: 7 kg

Table-top

safety glass 10 mm, $\phi = 700$ mm,
white glass-top
to be fixed to the base,
weight: 10 kg

remote control

to adjust the LED color



MATERIAL+COLOR

basic

base: 100,101
table-top: 300, 401, 402

option

all available colors in chapter
MATERIAL+COLOR

LED frame

steel, 1 mm, powder-coated
anthracite, white acrylic glass,
weight: 1,5 kg

Individual

other frame colors on request

illuminate your
table in any color



connection between table base and LED-frame

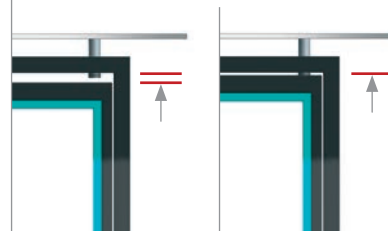

mounting of the LED-frame



folding-system of the SET Table



LED_FRAME_SET

66001100

[LxWxH]: 940 x 425 x 30 mm
weight: 5,5 kg

Base

steel, 1 mm, powder-coated
anthracite

Light frame

white acrylic glass,
30 x 15 mm

Electrical parts

input 100-240V, 50/60Hz,
working voltage 12~24V

additional LED frame
to upgrade your
cocktail table

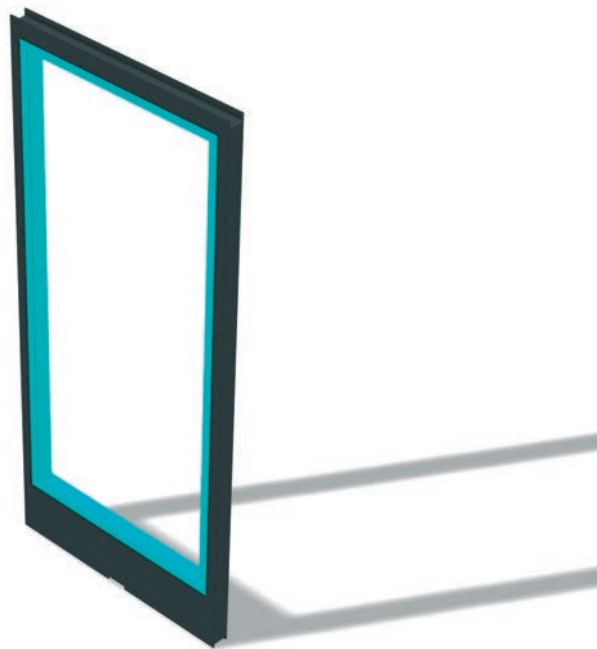

5 hours of
light capacity

remote control
to adjust the LED color



charging-system

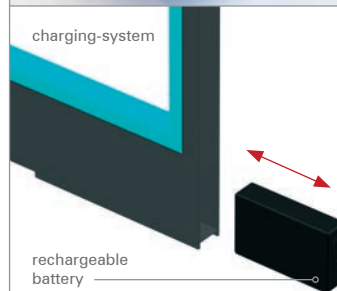

rechargeable
battery

Item No.: 99105
Trolley for 10 x LED frame



weight: 40 kg [empty] / 55 kg [full]

SET_100 | compact laminate

Item No.: 23017100402402

[LxWxH]: 1000 x 1000 x 1050 mm
weight: 24,7 kg

Base

steel, powder-coated anthracite
profile 30 x 30 mm, can be folded
weight: 8,8 kg

Table-top

compact laminate 10 mm,
ø = 1000 mm,
to be fixed to the base,
weight: 11,6 kg

Lower-tray

compact laminate 10 mm,
ø = 625 mm,
weight: 4,3 kg

only available in
compact laminate



MATERIAL+COLOR

basic

base: 100,101
table-top: 401, 402

option

all available colors in chapter
MATERIAL+COLOR

connection between table-top and base

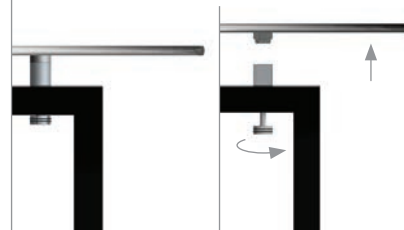

folding system

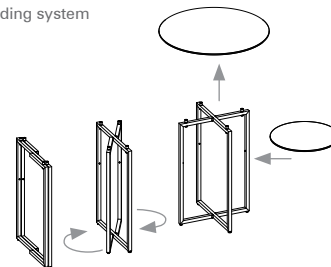

Item No.: 99164

Trolley for max. 5 x cocktail table_SET_100

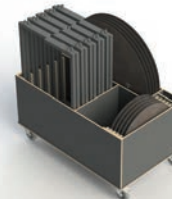

weight: 90 kg [empty] / 213,5 kg [full]

SET_100 | compact laminate

Item No.: 23018100402

[LxWxH]: 1000 x 1000 x 1050 mm
weight: 20,4 kg

Base

steel, powder-coated anthracite
profile 30 x 30 mm, can be folded
weight: 8,8 kg

Table-top

compact laminate 10 mm,
ø = 1000 mm,
to be fixed to the base,
weight: 11,6 kg



only available in
compact laminate

No Lower-tray !

MATERIAL+COLOR

basic

base: 100,101
table-top: 401, 402

option

all available colors in chapter
MATERIAL+COLOR

connection between table-top and base

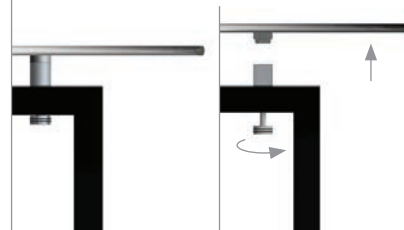

folding system

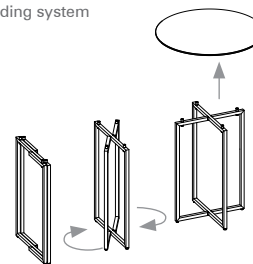

Item No.: 99164

Trolley for max. 5 x cocktail table_SET_100

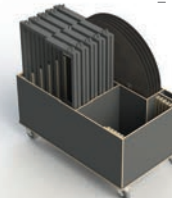

weight: 90 kg [empty] / 192 kg [full]

STAGE_50_L

Item No.: 51002100402

L: 1960 x 500 x 935 mm
total weight: 32,1 kg

Base

2 x main frame (VE-15800) 11,6 kg
2 x table leg (VE-15806) 5,0 kg
steel, powder-coated anthracite (100)
profile 40 x 40 mm, with height
compensation

height can
be adjusted
(93,5-117,5 cm)

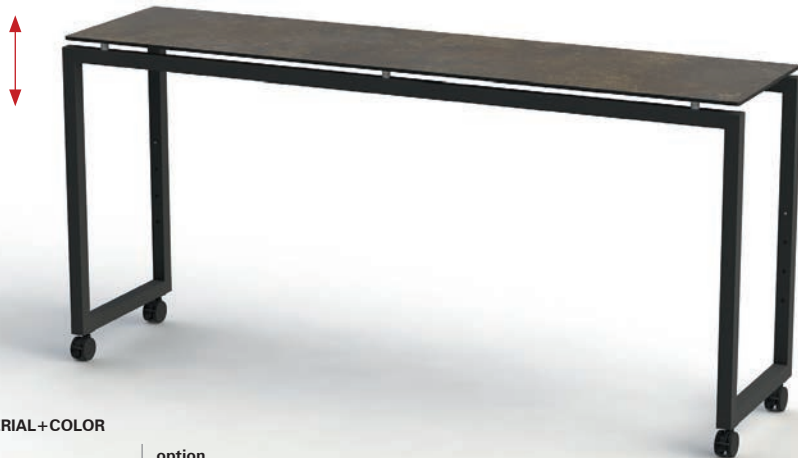

MATERIAL+COLOR

basic

base: 100, 101
table-top: 300, 401, 402

option

all available colors in chapter
MATERIAL+COLOR

4 x Castor (VE-11716)

diameter = 65 mm
weight: 0,5 kg

Height adjustable:

935 mm (lowest height)
1015, 1095, 1175 mm

Table-top (VE-14020)

compact laminate 10 mm,
ceramic anthracite (402)
weight: 15,0 kg

Alternative:

Table-top (VE-13026)

safety glass 10 mm,
transparent (300),
white colored (303)
weight: 24,0 kg

assembly of individual parts without tools

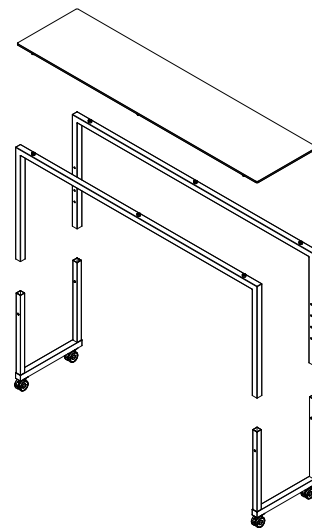

Item No.: 99109

Trolley for 4 x STAGE_50_L (maximum load)



weight: 75 kg [empty] / 203,4 kg [full]

STAGE_50_M

Item No.: 51003100402

L: 1960 x 500 x 855 mm
total weight: 29,1 kg

Base

2 x main frame 10,6 kg
2 x table leg 5,0 kg
steel, powder-coated anthracite (100)
profile 40 x 40 mm, with height
compensation

height can
be adjusted
(85,5-109,5 cm)



MATERIAL+COLOR

basic

base: 100,101
table-top: 300, 401, 402

option

all available colors in chapter
MATERIAL+COLOR

4 x Castor

diameter = 65 mm
weight: 0,5 kg

Height adjustable:

855 mm (lowest height)
935, 1015, 1095 mm

Table-top

compact laminate 10 mm,
ceramic anthracite (402)
weight: 13,0 kg

Alternative:

Table-top

safety glass 10 mm,
transparent (300),
white colored (303)
weight: 22,0 kg

assembly of individual parts without tools

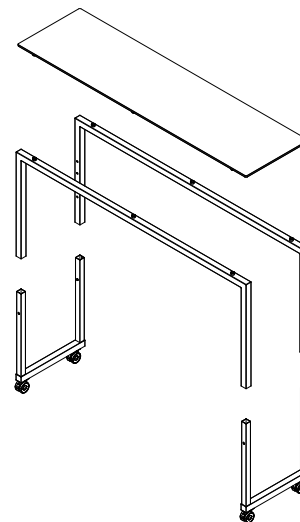

Item No.: 99109

Trolley for 4 x STAGE_80_M (maximum load)



weight: 75 kg [empty] / 191,4 kg [full]

PLATE_37

Item No.: 31001100280

[LxWxH]: 390 x 410 x 865 mm

seat-height: 765 mm

weight: 4,5 kg

Base

steel, powder-coated anthracite

profile 15 x 15 mm

weight: 3,5 kg

Seat

plywood 10 mm, bent, black

weight: 1,0 kg



MATERIAL+COLOR

basic

base: 100,101

seat: 279, 280

option

all available colors in chapter

MATERIAL+COLOR

side view



back view



arrangement (3 x Stool_PLATE_37_WHITE)



Item No.: 99133

Trolley for max. 10 x Stool_PLATE_37



weight: 16 kg [empty] / 61 kg [full]

BY_45

Item No.: 27004100300

[LxWxH]: 450 x 450 x 610 mm
weight: 10 kg

Base

steel, powder-coated anthracite
profile 30 x 30 mm, can be folded,
frame-measures: 430 x 430 x 560 mm
weight: 5 kg

Table-top

safety glass 10 mm, 450 x 450 mm,
to be fixed to the base,
weight: 5 kg

Individual

other colors on request

Special FEATURE

Table-top as small
as the width of the
metal frame to fit
in the trolley.
(inside of the frame)

connection between table-top and base

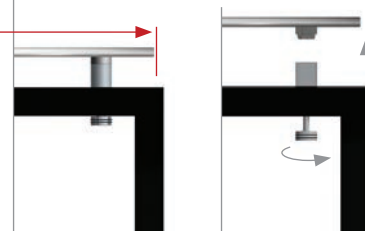

folding-system

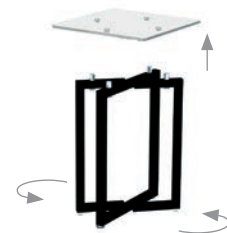

Item No.: 99142

Trolley for 10 x side table_BY_45

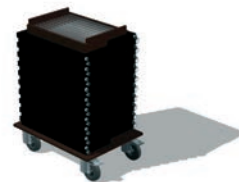

weight: 20 kg [empty] / 120 kg [full]



MATERIAL+COLOR

basic

base: 100,101
table-top: 300, 401, 402

option

all available colors in chapter
MATERIAL+COLOR

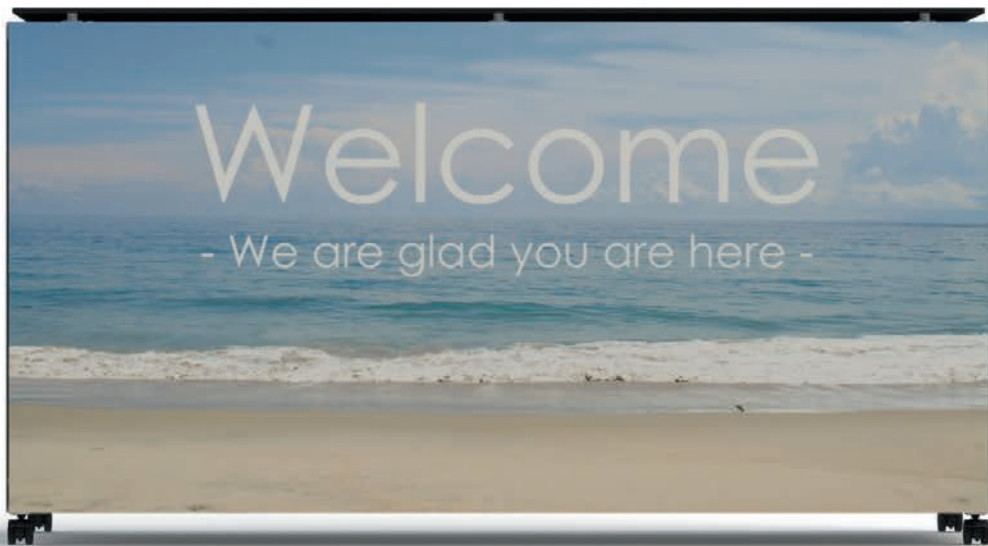

STAGE_50_L_HOSPI_DESK

Item No.: 51030100402

[LxWxH]: 1960 x 500 x 1095 mm
total weight: 32,1 kg

Base

2 x main frame 11,6 kg
2 x table leg 5,0 kg
steel, powder-coated anthracite (100)
profile 40 x 40 mm, with height
compensation

4 x Castor

diameter = 65 mm
weight: 0,5 kg

Height with BLINDS:

1095 mm (fix)

Table-top

compact laminate 10 mm,
ceramic anthracite (402)
weight: 15,0 kg

1 x FRONTBLIND_STAGE_L_108

Item No.: 38050100402

[LxWxH]: 1960 x 982 x 17 mm
weight: 7,8 kg

2 x SIDEBLIND_STAGE_50_108

Item No.: 38056100402

[LxWxH]: 500 x 982 x 17 mm
weight: 2,0 kg

OPTIONAL: SHELF_47



backside view



picture shows
decoration items

OPTIONAL: SHELF_LOW

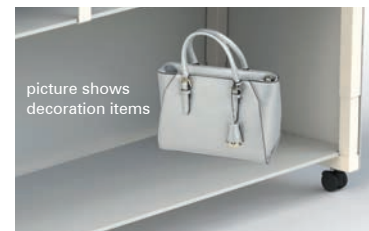

picture shows
decoration items



MATERIAL+COLOR

basic

base: 100,101
table-top: 401, 402
cover: 401, 402

option

all available colors in chapter
MATERIAL+COLOR

surface (compact panel /
high pressure laminate) can
be used for sticking logos
(optional application)

STAGE_50_BACKBAR_160_5



STAGE_50_BACKBAR_160_5

STAGE_50_BACKBAR_160_5

Item No.: 34101100402

[LxWxH]: 1600 x 500 x 1825 mm

weight: 99,3 kg

metal parts

steel, powder-coated (100)

total weight: 39,8 kg

top and bottom shelf (2 x)

[LxWxH]: 1830 x 500 x 10 mm

weight: 11,8 kg

middle shelf (3 x)

[LxWxH]: 1510 x 310 x 40 mm

weight: 11,8 kg

4 x Castor

diameter = 65 mm

weight: 0,5 kg



MATERIAL+COLOR

basic

base: 100,101

shelf: 401, 402

option

all available colors in chapter

MATERIAL+COLOR

overview of all single parts assembling by screws

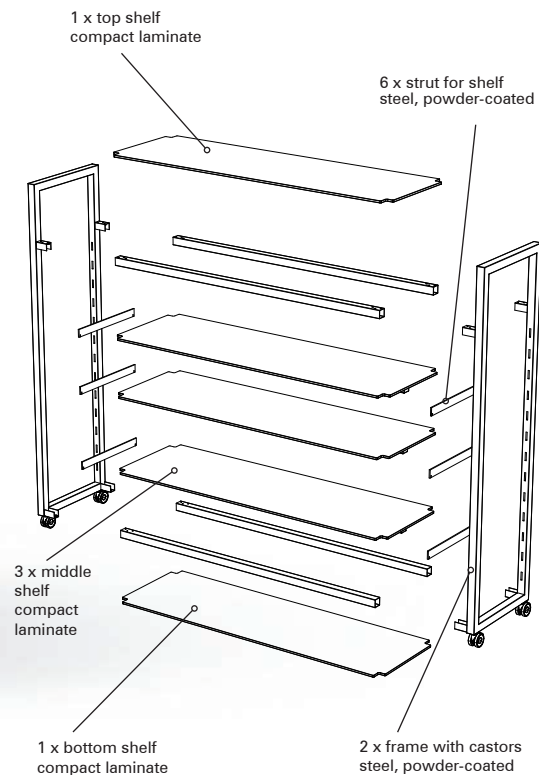

STAGE_50_BACKBAR_160_4



STAGE_50_BACKBAR_160_4

STAGE_50_BACKBAR_160_4

Item No.: 34102100402

[LxWxH]: 1600 x 500 x 1825 mm

weight: 83,7 kg

metal parts

steel, powder-coated (100)

total weight: 39,5 kg

top and bottom shelf (2 x)

[LxWxH]: 1830 x 500 x 10 mm

weight: 11,8 kg

middle shelf (2 x)

[LxWxH]: 1510 x 310 x 40 mm

weight: 11,8 kg

4 x Castor

diameter = 65 mm

weight: 0,5 kg

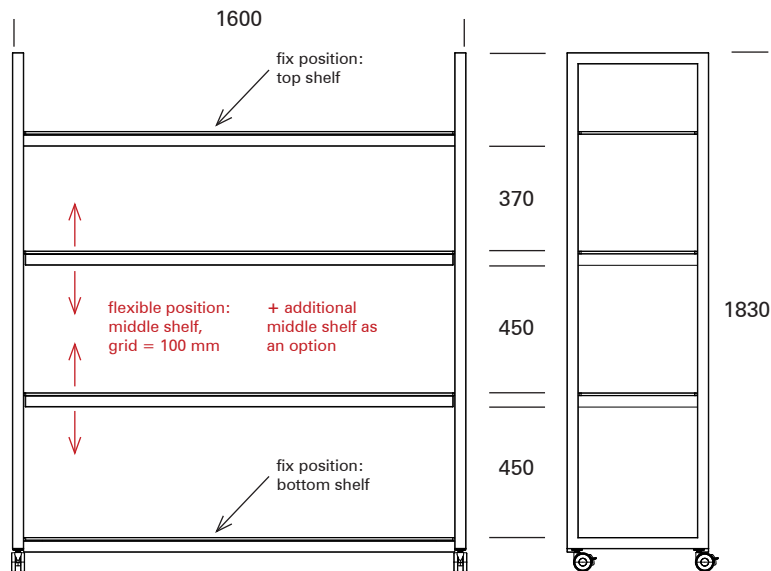

MATERIAL+COLOR

basic

base: 100,101

shelf: 401, 402

option

all available colors in chapter

MATERIAL+COLOR

+ additional shelf option

SHELF_MIDDLE_STAGE_50_BACKBAR_160

Item No.: 50053

[LxWxH]: 1510 x 310 x 50 mm

weight: 15,6 kg

metal parts

steel, powder-coated (100)

total weight: 3,8 kg

middle shelf

[LxWxH]: 1510 x 500 x 10 mm,

material: compact laminate

weight: 11,8 kg

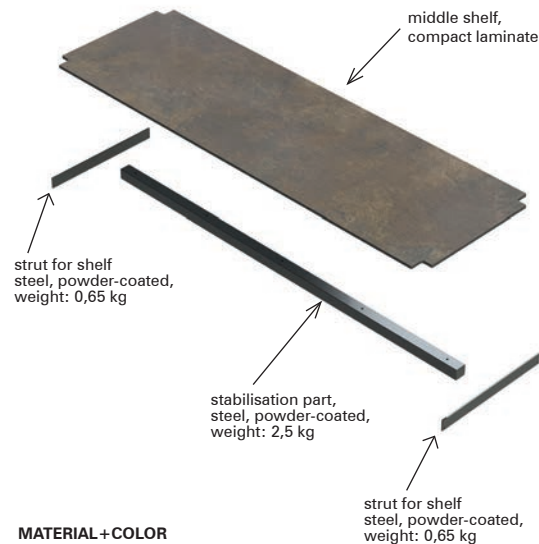

MATERIAL+COLOR

basic

metal parts: 100,101

shelf: 401, 402

option

all available colors in chapter

MATERIAL+COLOR

SIDEBLIND_STAGE_50_BACKBAR_160

Item No.: 38117100402

L: 500 x 1752 x 13 mm
total weight: 3,6 kg

Sideblind

compact panel, 3 mm, decor: ceramic anthracite (402)

Metal part

steel, powder-coated anthracite (100)
bended steel

Connecting part

magnet d = 20 mm glued on the sideblind



MATERIAL+COLOR

basic

base: 100, 101
sideblind: 401, 402

option

all available colors in chapter
MATERIAL+COLOR

SIDEBLINDS are available in all decor options (MATERIAL+COLOR)

mounting the SIDEBLIND at the BACKBAR

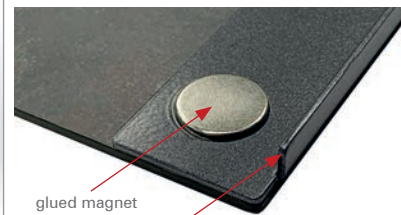
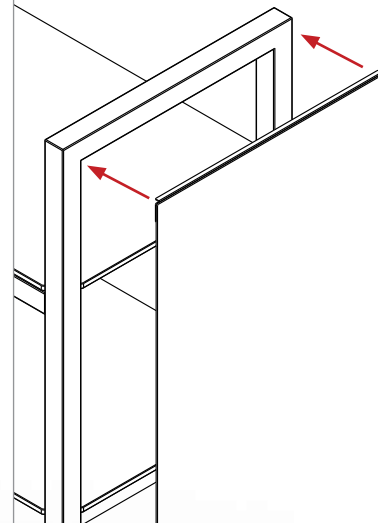

glued magnet
d = 20 mm

long hook (glued on the compact laminate panel)

SIDEBLIND_STAGE_50_BACKBAR_160_STRIPES_COVERED

Item No.: 38115100620

L: 1752 x 500 x 17 mm
total weight: 8,2 kg

Sideblind

steel, laser-cut decor „STRIPES”,
powder-coated, anthracite (100)

Cover

polyester, decotex, color: white
translucent (620)

Connecting part

magnet d = 20 mm glued on the
sideblind



backside cover only
available in color:
620, 621, 622

MATERIAL+COLOR

basic

base: 100, 101
cover: 620, 621, 622

option

all available colors in chapter
MATERIAL+COLOR

mounting the SIDEBLIND at
the BACKBAR

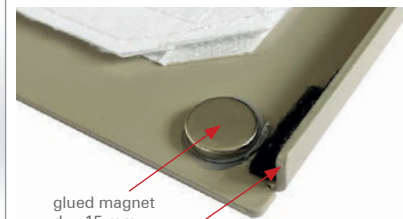
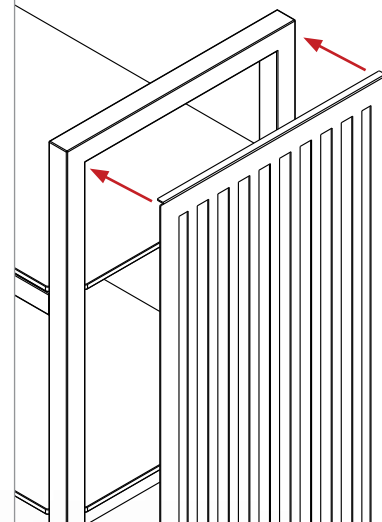

glued magnet
d = 15 mm

long hook
bended metal

Mobile Bar system with
Backbar and Stools

M Table (1800 x 500 mm)

S Table (1600 x 800 mm)



Mobile_Bar_Blinds

The Mobile Bar – a design experience, with an exclusive, modern design, flexibility and versatility.

The proven STAGE buffet system from our VENTA interior program can be transformed into a mobile bar. Instead of the glass-tops that are already part of all versions, we have added an additional table-top option to our portfolio. The compact-top is a durable plastic surface.

We use this top both as a table-top and as a fascia, transforming a STAGE buffet table into a mobile bar in just a few seconds. With additional magnetic plates (FRONTBLIND and SIDE-BLIND) the bar table (STAGE_80_M) is covered.

To make it perfect, you only need one more piece of furniture from the STAGE buffet system. With the STAGE_50_L buffet table as a counter, the mobile bar is ready for use. The table-top of the STAGE_50_L can be made of a glass-top (especially color matching) or a compact-top. There are almost no limits to the possible combinations. The mobile bar can be adapted to the color theme of the room or the event theme.

We offer two standard versions of the mobile bar – the corresponding table frames in the standard colors anthracite and champagne and the table tops and blinds in ceramic anthracite and premium white.

STAGE_MOBILE_BAR_BLINDS (Table L + Table M + BLINDS)

Table: STAGE_50_L
Item No.: 51002100402
[LxWxH]: 1960 x 500 x 935 mm
total weight: 32,1 kg

Table: STAGE_80_M
Item No.: 81003100402
[LxWxH]: 1800 x 800 x 855 mm
total weight: 35,8 kg

FRONTBLIND_STAGE_M
Item No.: 38044100402
[LxWxH]: 1800 x 822 x 17 mm
weight: 6,0 kg

SIDEBLIND_STAGE_80
Item No.: 38048100402
[LxWxH]: 800 x 822 x 17 mm
weight: 2,7 kg

bar-system
applicable with all
STAGE-tables



MATERIAL+COLOR

basic

base: 100, 101
table-top: 300, 401, 402
cover: 401, 402

option

all available colors in chapter
MATERIAL+COLOR

connection between table-top and base

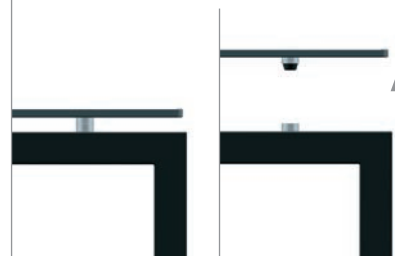

side cover
at table STAGE_80_M



front cover
at table STAGE_80_M



Item No.: 99124

Trolley for 2 x Mobile Bar



weight: 70 kg [empty] / 277 kg [full]

STAGE_MOBILE_BAR_BLINDS (Table L + Table M + BLINDS)

perfect system
to build up a new
application in a few seconds ...

table-top size:
1950 x 490 mm
material options:
compact panel
or glass top



space for equipment
(refrigerator/wastebin)

1 x STAGE_50_L
1 x STAGE_80_M
1 x FRONTBLIND_M
2 x SIDEBLIND_80

optional equipment/arrangement



Stool_PLATE_37

STAGE_50_M



Backbar



STAGE_MOBILE_BAR_VARIO | ICE WELL | VERSION 1

Item No.: 86005100402402



1 x base_STAGE_80_S / 81039100
1 x table-top_XS / 14018402
1 x table-top-unit_ICE_WELL / 11084100402



1 x FRONTBLIND_STAGE_S / 38046100402
2 x SIDEBLIND_STAGE_80 / 38048100402



1 x STAGE_50_M / 51003100402



optional equipment:
container 1/1 GN perforated
Item No.: 12309



optional equipment:
inlay perforated 2/1 GN+4 x distance_block
Item No.: 12345



delivery content:
including 2 x inlay panel
to close the ice well

STAGE_MOBILE_BAR_VARIO | ICE WELL | VERSION 2

Item No.: 86006100402402



1 x base_STAGE_80_S / 81039100
1 x table-top_XS / 14018402
1 x table-frame_ELEMENTS / 20007199



1 x 20012402
1 x 20040402
1 x 20017

1 x FRONTBLIND_STAGE_S / 38046100402
2 x SIDEBLIND_STAGE_80 / 38048100402



1 x STAGE_50_M / 51003100402



optional equipment:
container 1/1 GN perforated
Item No.: 12309



optional equipment:
inlay perforated 1/1 GN+4 x distance_block
Item No.: 12344



delivery content:
including 1 x inlay panel
to close the ice well

STAGE_MOBILE_BAR_VARIO | ICE WELL | VERSION 3

Item No.: 86007100402402



1 x base_STAGE_80_S / 81039100
 1 x table-top_XS / 14018402
 1 x table-frame_ELEMENTS / 20007199



2 x 20040402
 2 x 20017

1 x FRONTBLIND_STAGE_S / 38046100402
 2 x SIDEBLIND_STAGE_80 / 38048100402



1 x STAGE_50_M / 51003100402



optional equipment:
 container 1/1 GN perforated
 Item No.: 12309



optional equipment:
 inlay perforated 1/1 GN+4 x distance_block
 Item No.: 12344



delivery content:
 including 2 x inlay panel
 to close the ice well

STAGE_MOBILE_BAR_VARIO | ICE WELL | VERSION 4

Item No.: 86008100402402



optional equipment:
container 1/1 GN perforated
Item No.: 12309



optional equipment:
inlay perforated 1/1 GN+4 x distance_block
Item No.: 12344



delivery content:
including 2 x inlay panel
to close the ice well

1 x base_STAGE_80_S / 81039100
2 x table-frame_ELEMENTS / 20007199



2 x 20012402
2 x 20040402
2 x 20017

1 x FRONTBLIND_STAGE_S / 38046100402
2 x SIDEBLIND_STAGE_80 / 38048100402



1 x STAGE_50_M / 51003100402



STAGE_MOBILE_BAR_VARIO | ICE WELL | VERSION 2 | 90° rotated

Item No.: 86006100402402



1 x base_STAGE_80_S / 81039100
1 x table-top_XS / 14018402
1 x table-frame_ELEMENTS / 20007199



1 x 20012402
1 x 20041402
1 x 20017

1 x FRONTBLIND_STAGE_S / 38046100402
2 x SIDEBLIND_STAGE_80 / 38048100402



1 x STAGE_50_M / 51003100402



optional equipment:
container 1/1 GN perforated
Item No.: 12309



optional equipment:
inlay perforated 1/1 GN+4 x distance_block
Item No.: 12344



delivery content:
including 1 x inlay panel
to close the ice well

STAGE_MOBILE_BAR_VARIO | ICE WELL | VERSION 4 | 90° rotated

Item No.: 86008100402402



1 x base_STAGE_80_S / 81039100
2 x table-frame_ELEMENTS / 20007199



2 x 20012402
2 x 20041402
2 x 20017

1 x FRONTBLIND_STAGE_S / 38046100402
2 x SIDEBLIND_STAGE_80 / 38048100402



1 x STAGE_50_M / 51003100402



optional equipment:
container 1/1 GN perforated
Item No.: 12309



optional equipment:
inlay perforated 1/1 GN+4 x distance_block
Item No.: 12344



delivery content:
including 2 x inlay panel
to close the ice well



SPEEDRAIL_80

Item No.: 66085199

[LxWxH]: 800 x 170 x 200 mm
total weight: 3,0 kg

Base

stainless steel, brushed surface

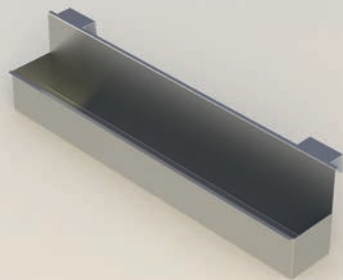

mounting the SPEEDRAIL_80 at the frame of a
STAGE_80_XS table

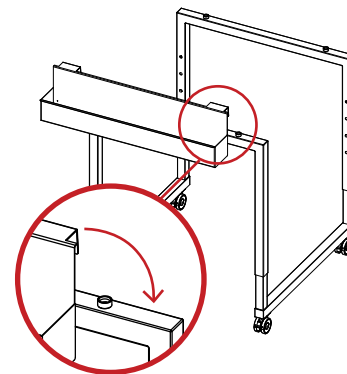

MATERIAL+COLOR

basic	option
base: 199	no other color option available

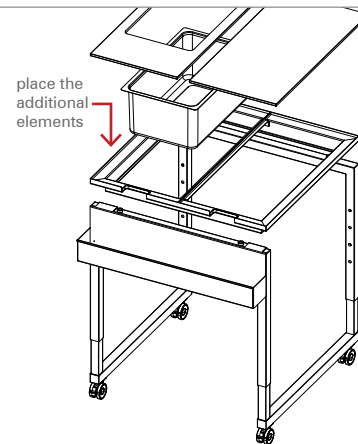

Service Furniture

Coffee Station | Cupboard | Rack



STAGE_80_COFFEE_STATION_SQ

Item No.: 81017101401267

[LxWxH]: 800 x 800 x 935 mm
weight: 70,0 kg

Base

steel, powder-coated champagne (101)
profile 40 x 40 mm, castors
diameter = 75 mm (all with brake)

Table-top

compact laminate 10 mm, with one
hole for disposal of coffee dregs
decor: premium white (401)

Designed for WMF
coffee machine (1500S+
and 5000S+), but can be
customized also for other
brands.



MATERIAL+COLOR

basic

base: 100, 101
cupboard: 267, 268
table-top: 401, 402

option

all available colors in chapter
MATERIAL+COLOR

only available on castors
diameter = 75 mm



setup 1 (standard)

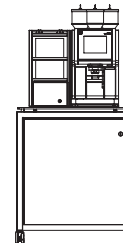

setup 2

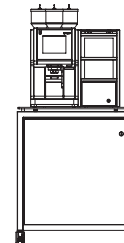

STAGE_80_COFFEE_STATION_RE

Item No.: 81018101401267

[LxWxH]: 1200 x 800 x 935 mm
weight: 80,0 kg

Base

steel, powder-coated anthracite (100)
profile 40 x 40 mm, castors
diameter = 75 mm (all with brake)

Table-Top

compact laminate, 10 mm, with one
hole for disposal of coffee dregs
decor: ceramic anthracite (402)

Designed for WMF
coffee machine (1500S+
and 5000S+), but can be
customized also for other
brands.

MATERIAL+COLOR

basic

base: 100,101
cupboard: 267,268
table-top: 401, 402

option

all available colors in chapter
MATERIAL+COLOR

Cupboard

melamine faced, chipboard 19 mm, two doors which can be locked,
decor: ceramic anthracite (402)



**only available on castors
diameter = 75 mm**

setup 1
(standard)

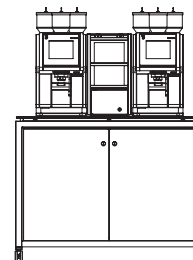

setup 2

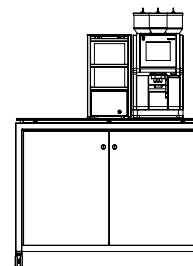

setup 3

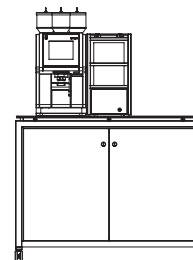

STAGE_80_CUPBOARD_SQ

Item No.: 81043100268402

[LxWxH]: 800 x 800 x 935 mm
weight: 70,0 kg

Base

steel, powder-coated anthracite (100)
profile 40 x 40 mm, castors
diameter = 75 mm (all with brake)

Table-top

compact laminate, 10 mm,
decor: ceramic anthracite (402)
weight: 8,8 kg

Cupboard

melamine faced, chipboard 19 mm,
one door which can be locked,
decor: ceramic anthracite (402)

The cupboard has two shelves
inside. The height of the shelves is
adjustable. One door can be locked.

Please define the door stop side
when you place an order (where the
hinges should be fixed).

top view
hinge side has to be defined



Standard
hinge left side

**MATERIAL+COLOR****basic**

base: 100, 101
cupboard: 267, 268
table-top: 401, 402

option

all available colors in chapter
MATERIAL+COLOR

**only available on castors
diameter = 75 mm**

two adjustable shelves inside

**Alternative / Table-top**

safety glass 10 mm, underside black colored (307)



STAGE_80_CUPBOARD_RE

Item No.: 81082100268402

[LxWxH]: 1200 x 800 x 935 mm
weight: 80 kg

Base

steel, powder-coated anthracite (100)
profile 40 x 40 mm, castors
diameter=75 mm (all with brake)

Table-top

compact panel, 10 mm
decor: ceramic anthracite (402)
weight: 10 kg

Cupboard

melamine faced, chipboard 19 mm,
two doors which can be locked



MATERIAL+COLOR

basic

base: 100,101
cupboard: 267, 268
table-top: 401, 402

option

all available colors in chapter
MATERIAL+COLOR

only available on castors
diameter = 75 mm

Alternative / Table-top

safety glass 10 mm, underside black colored
(307), weight: 23,0 kg



The cupboard inside has two
shelves in each side. The height of
the shelves is adjustable.

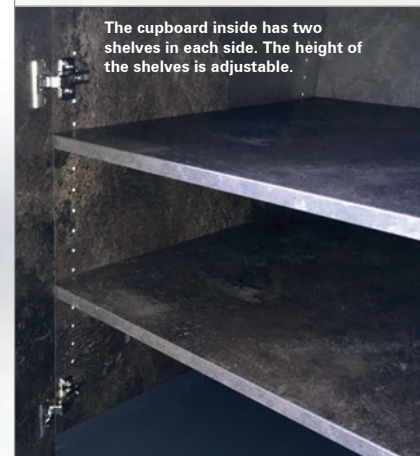



STAGE_80_XS_RACK

STAGE_80_XS_RACK

Item No.: 81088268402

[LxWxH]: 800 x 800 x 935 mm

weight: 109,7 kg

Rack

chipboard with ABS edge
material thickness: 38 mm,
color: ceramic anthracite (268)

Table-top: 402
(ceramic anthracite)
structure ST10

rack: 268
(ceramic anthracite)
structure ST87



MATERIAL+COLOR

basic

rack: 267, 268

table-top: 401, 402

option

all available colors in chapter

MATERIAL+COLOR

Table-top

Item No.: 14018

compact laminate 10 mm,

ceramic anthracite (402)

weight: 8,8 kg

Castor (4 pieces)

Item No.: 11716

diameter = 65 mm

weight: 0,5 kg

Alternative:

Table-top

Item No.: 13006

safety glass 10 mm,

transparent (300),

white colored (303)

weight: 15,0 kg

SPECIAL FEATURES:

Magnetic „WOOD“
It is possible to close
the rack with the VENTA
SIDEBLIND_80.

Frontside with three com-
partments / backside with
two compartments.



81088267401 / side with three compartments



81088267401 / side with two compartments





RACK

The RACK in the dimension 50 x 80 cm is a perfect addition to the existing STAGE system. All plates, bowls, glasses and cutlery required at the buffet can be perfectly accommodated here.

The RACK has fixed shelves which are separated from each other by a central wall.

On one side there is only one shelf in the middle, while on the other side are two fixed shelves. Depending on the required height of use, the customer selects the suitable side. The open sides can be closed by VENTA Standard SIDEBLINDS so that the contents disappear behind them. The shelf walls are equipped with magnets so that the SIDEBLINDS can be attached to them.

The shelving system is available for a buffet depth of 80 cm in widths of 50 and 80 cm.

STAGE_80_XS_50_RACK

STAGE_80_XS_RACK

Item No.: 81089268402

[LxWxH]: 500 x 800 x 935 mm

weight: 66,6 kg

Rack

chipboard with ABS edge
material thickness: 38 mm,
color: ceramic anthracite (268)

Table-top

compact laminate 10 mm,

ceramic anthracite (402)

weight: 8,8 kg

Castor

diameter = 65 mm

weight: 0,5 kg

Alternative:

Table-top

safety glass 10 mm,

transparent (300),

white colored (303)

Table-top: 402
(ceramic anthracite)
structure ST10

rack: 268
(ceramic anthracite)
structure ST87



SPECIAL FEATURES:

Magnetic „WOOD“
It is possible to close
the rack with the VENTA
SIDEBLIND_50.

Frontside with three compartments / backside with two compartments.



81089267401 / side with three compartments



81089267401 / side with two compartments



MATERIAL+COLOR

basic

rack: 267, 268

table-top: 401, 402

option

all available colors in chapter

MATERIAL+COLOR

Equipment

Heavy Load Strut | Cable Duct | Rollerskate | Silicone Pads | Cables



VENTA
BY BÜCHIN DESIGN

HEAVY_LOAD_STRUT_STAGE

HEAVY_LOAD_STRUT_STAGE_80_V3

Item No.: 15066

[LxWxH]: 750 x 40 x 37 mm
weight: 0,75 kg

Material

steel, profile 15 x 15 mm + 3 mm
bended steel, powder-coated
anthracite

additional item
to place heavy
equipment on the
STAGE tables

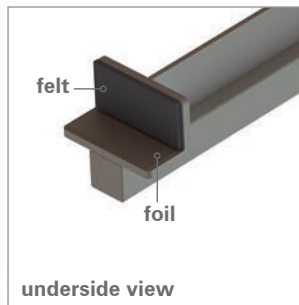

MATERIAL+COLOR

basic

base: 100, 101

option

all available colors in chapter MATERIAL+COLOR

HEAVY_LOAD_STRUT_STAGE_50_V3

Item No.: 15068

[LxWxH]: 450 x 40 x 37 mm
weight: 0,35 kg

Material

steel, profile 15 x 15 mm + 3 mm
bended steel, powder-coated
anthracite

15066 - for all STAGE_80 tables

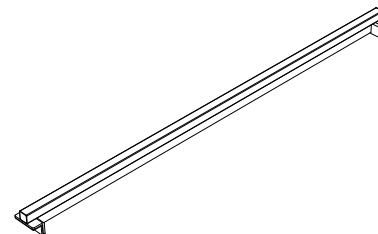

15068 - for all STAGE_50 tables

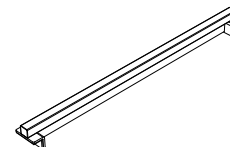

HEAVY_LOAD_STRUT_STAGE

Use the additional strut in case of placing heavy equipment such as coffee machines, ham slicing machines or any other heavy equipment.

The recommended quantity of struts depends on the weight and the dimension of the items placed on the table.

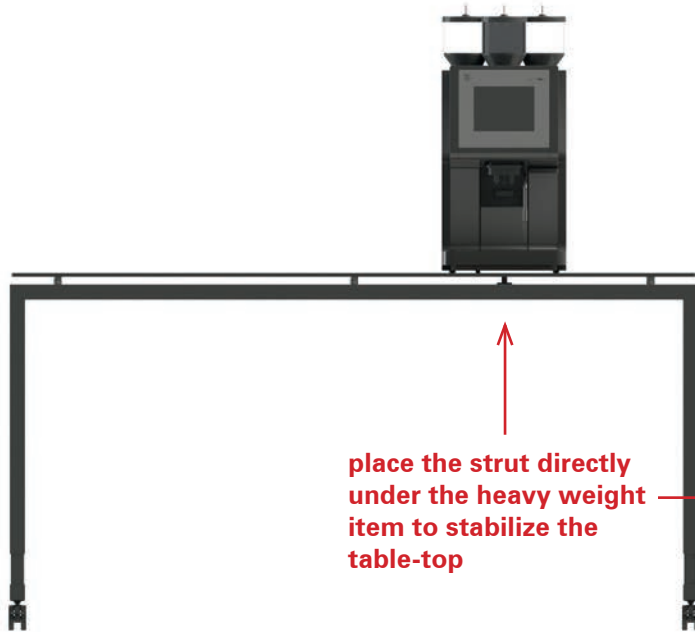

**place the strut directly
under the heavy weight
item to stabilize the
table-top**



CABLE_DUCT

Item No.: 11765

[LxWxH]: 770 x 35 x 21 mm
weight: 0,965 kg

Material

steel, 1 mm, bended, powder-coated anthracite

Item No.: 11766

[LxWxH]: 610 x 35 x 21 mm
weight: 0,85 kg

Material

steel, 1 mm, bended, powder-coated anthracite

Item No.: 11767

[LxWxH]: 400 x 35 x 21 mm
weight: 0,75 kg

Material

steel, 1 mm, bended, powder-coated anthracite

additional
equipment to
hide the cable

**MATERIAL+COLOR****basic**

base: 100, 101

option

all available colors in chapter MATERIAL+COLOR

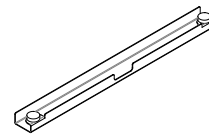
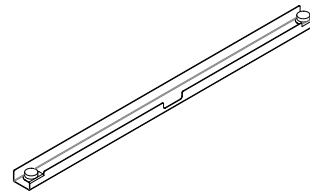
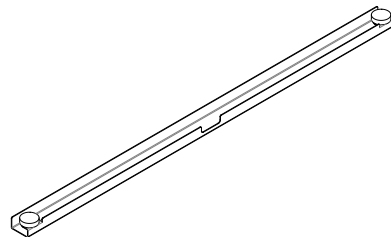

ROLLERSKATE_QUADRO

Item No.: 66007

[LxWxH]: 600 x 600 x 98 mm

weight: 2,4 kg

Material

steel, 2,5 mm, bended, powder-coated
anthracite



**additional
equipment to
move the table**



MATERIAL+COLOR

basic

base: 100, 101

option

all available colors in chapter MATERIAL+COLOR

**caster
Ø = 50 mm**

SILICONE PAD

Item No.: 66008

[LxWxH]: Ø = 150 mm, height = 3 mm

weight: 0,035 kg

material: silicone, black



Item No.: 66030

[LxWxH]: Ø = 200 mm, height = 4,5 mm

weight: 0,079 kg

material: silicone, black



Item No.: 66037

[LxWxH]: 315 x 168 mm, height = 5 mm

weight: 0,184 kg

material: silicone, black



equipment for
glass-top tables
and induction
tables

MAGNETIC PLUGBAR + EXTENSION CABLES

Item No.: 11060

cable length: 5 m / plug type: F (EU)
weight: 1,0 kg



Item No.: 11064

cable length: 5 m / plug type: F (EU)
weight: 0,6 kg



Item No.: 11078

[LxWxH]: 400 x 80 x 50 mm
cable length: 5 m / plug type: F (EU)
weight: 1,5 kg



equipment to
manage the
cables

CASTORS (spare parts)



Item No.: 11715

[LxWxH]: 50 x 47 x 66 mm / diameter = 50 mm,
weight: 0,1 kg, material: housing polyamide,
wheels: polyurethane

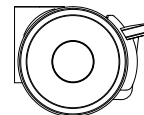

Item No.: 11716

[LxWxH]: 80 x 45 x 65 mm / diameter = 65 mm,
weight: 0,125 kg, material: housing polyamide,
wheels: polyurethane

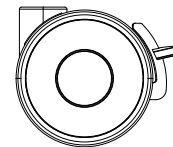

Item No.: 11741

[LxWxH]: 95 x 55 x 75 mm / diameter = 75 mm,
weight: 0,2 kg, material: housing polyamide,
wheels: polyurethane

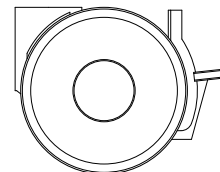

PROTECTIVE_COVER_STAGE

Item No.: 78010

[LxWxH]: 820 x 520 x 850 mm

weight: 2,5 kg

Features

protective cover for assembled VENTA buffet tables

material: plastic fabric, inside padded with 10 mm foam and lined with nylon (110D)

2 x zipper on one narrow side

clear pocket in size DIN A4 for inserting information sheets

**additional equipment
to protect the tables**

**available for all STAGE
tables (80/50)**

INDOOR USE with
material polyester
VENTA-CODE: 666

OUTDOOR USE with
material PVC
(polyvinyl chloride)
VENTA-CODE: 667



illumination by LED panels

This is the additional LED equipment for your buffet-table to create a unique and comfortable atmosphere for your guests.

Additionally you need only the VENTA decor blinds and the Shelf_Low to place the lights onto.



LED_PANEL | SQ + RE

Item No.: 66033

[LxWxH]: 625 x 625 x 54 mm
weight: 4,2 kg



LED_PANEL_SQ

suitable for all **STAGE_80** tables

Item No.: 66034

[LxWxH]: 600 x 300 x 54 mm
weight: 4,0 kg



LED_PANEL_RE

suitable for all **STAGE_50** tables

Features

LED surface light for illuminating STAGE tables with BLINDS (COVER: Decotex, white, translucent)
model number: RGB+CCT-36W, DC 24V,
input: 100-240V, features: RGB mode,
colour adjustable 2700-6500K, brightness
dimnable, supplied with remote control

Available with various plug options:
EU / UK / CH



Lectern

exchangeable front display

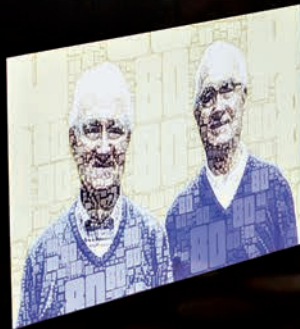

LECTERN_3G

Item No.: 35001

[LxWxH]: 500 x 600 x 1200 mm
weight: 30 kg

Body

acrylic glass, color: anthracite

Front-board

acrylic glass, transparent,
600 x 1090 mm

Base

metal plate, 2 mm,
color: anthracite, powder-coated

delivery version:
black front cover
(exchangeable)

Features:

exchangeable front for printings
LED reading lamp
preparation for microphone
soft cover for transport and storage
rollerskate

all electrical properties use standard
power supply of 230V/50Hz
plug: schuko (CEE 7/4)



front view



height: 120 cm



cable inlet under
the metal plate

Features

All VENTA furniture has special features that make our exclusive products distinctive and unique. Each individual product was designed as a foldable, stackable or modular system, so our high-quality furniture can always be securely stored, taking up very little space.

A matching trolley system is available for all VENTA furniture items, where the table parts can be stacked individually and secured in place against one another.

All VENTA furniture is put together without the use of any tools and there are no parts that can get lost. The connecting elements between the table frame and table-top are always made of stainless steel and are produced using high-precision lathes. The consistent quality of our products is ensured through regular physical controls.

VENTA products are designed as foldable, stackable or modular systems, enabling our furniture to be stored securely and using very little space. We also offer additional equipment for many VENTA products to make them even more simple and convenient to manage. All foldable tables can be equipped with rollerskates, for example. This enables the buffet tables to be moved around the room quickly and easily without having to carry them or take them apart and put them together again.

Features of VENTA products

feet-adjustment

The cocktail tables have three feet which are fixed. The fourth foot is adjustable. You can use your own foot to adjust easily the stability.



glass-top mounting

The cocktail tables and most of the buffet tables have a special feature to fix the glass-top to the base. The screw is mounted undetachable on the base.

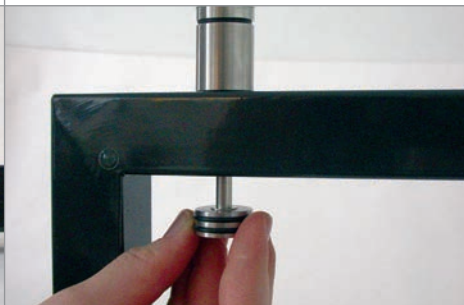

glass-top quality

All glass-tops are produced as safety glass. In case of damage, they will break into small pieces to avoid any injury.

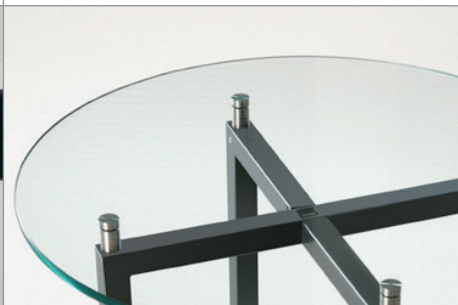

trolleys for storage

For almost all VENTA products we offer trolleys to store the goods. You can store ten cocktail tables in a trolley in less than 0,6m².



foldable furniture

Nearly all VENTA products are foldable.



stackable furniture

The stools can be stacked up to ten pieces.



Material + Color

BASIC and OPTION

Büchin Design offers a wide range of materials and colors in two categories **BASIC** and **OPTION**.

The category **LUXURY** is only available for gold and silver colored glass tops.

All VENTA items have a unique five-digit item number.

example: 23001 for the table model SET_70

To define the material + color of the model, just add the three-digit material code.

example: 23001 + 100 (base frame = anthracite) + 300 (table-top = glass, transparent) + 300 (lower-tray = glass, transparent).



Metal | color options

BASIC | 2 colors



OPTION | 13 colors

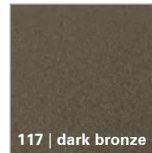
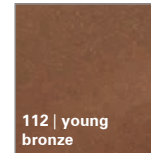
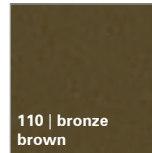
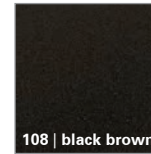
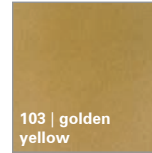

Additional Colors | select your color from IGP-range
(number 58 / color code: IGP DURA face/pearl mica effect)

Glass | color options

BASIC | only transparent glass (floatglass)

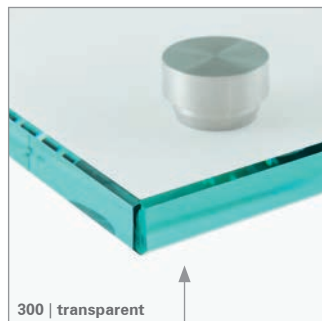

OPTION | 7 colors

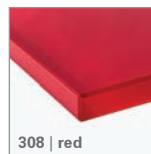
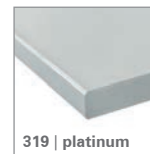

OPTION | choose any RAL color you like

LUXURY | two special metal colors

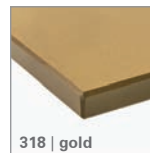

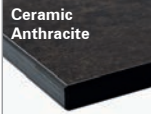

Compact panel | color options

BASIC | 2 decor options (table-top, shelf)











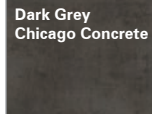

 Solid Alpine White 401	 Ceramic Anthracite 402 champagne	decor name
401	402 champagne	color-code

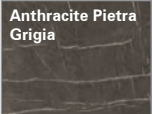
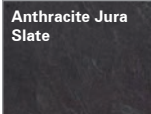
blinds in 3 mm (all with black core)

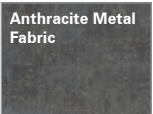
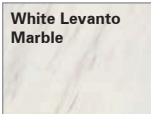
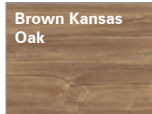
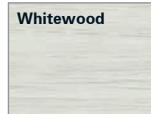
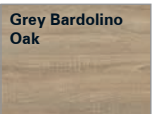
 Solid Alpine White 401
--

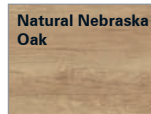

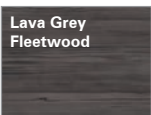
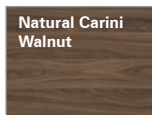
OPTION | 20 decor options (table-top, shelf, blind)

 Anthracite Metal Rock 431	 Light Grey Chicago Concrete 414	 Dark Grey Chicago Concrete 415	 White Carrara Marble 429
 Anthracite Pietra Grigia 432	 Anthracite Jura Slate 433	 Ferro Bronze 416	 Brown Linen 424
 Anthracite Metal Fabric 434	 White Levanto Marble 435	 Brown Kansas Oak 436	 Whitewood 417
 Grey Bardolino Oak 437	 Vintage Santa Fe Oak 438	 Graphite Denver Oak 439	 Natural Nebraska Oak 440
 White Aland Pine 412	 Lava Grey Fleetwood 419	 Natural Carini Walnut 430	 Natural Dijon Walnut 441

Chipboard decor | color options

BASIC | 2 decor options (coffee station, cupboard, rack)

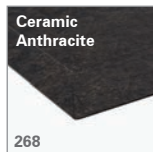

melamine-faced chipboard, 19 mm,
decor similar to HPL
ceramic anthracite (268)

table-top material:
compact panel, 10 mm
(black core)
ceramic anthracite (402)



cupboard / coffee station / rack

OPTION | 20 decor options (coffee station, cupboard, rack)

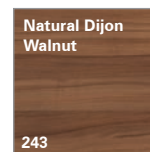
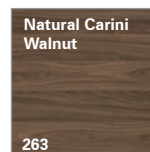
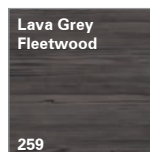
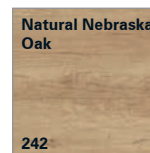
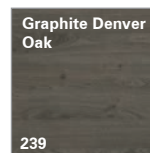
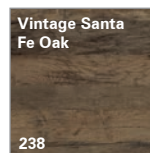
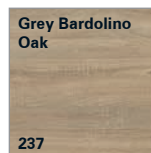
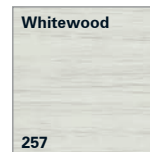
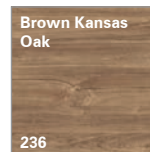
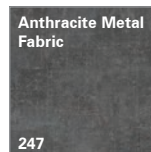
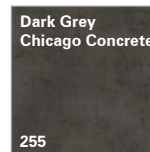
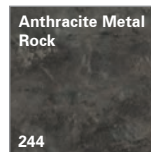

Plywood with HPL | color options

BASIC | 2 decor options

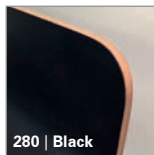

color-code



Polyester | color options

BASIC | 3 decor variations

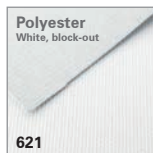
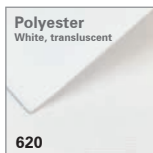

cover on the back in polyester

example: polyester block-out, ceramic anthracite printed, VENTA-Code: 622

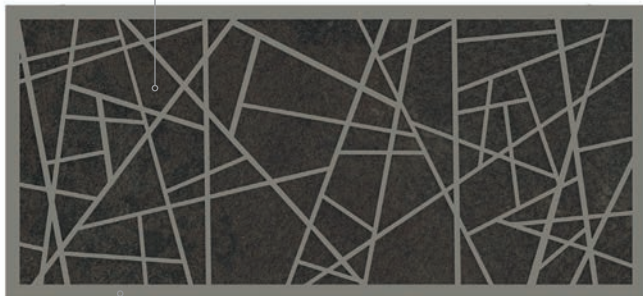

metal part in IGP-color

example: champagne, VENTA-Code: 101



Partner & Reseller

VENTA tables all around the world

VENTA products can be found all around the world in the showrooms of our partners.

We cooperate with other manufacturers of high quality hotel equipment like **Frilich** for the breakfast stations and **Zieher** for exclusive tableware.

WMF has in total four showrooms equipped with VENTA buffet tables.
Berlin, Birkenfeld, Düsseldorf, Hamburg

The **Hotelkompetenzzentrum** in Munich has also a selection of our tables.

Distribution partner who are selling our products worldwide:

Germany / Autenrieb
Switzerland / Cash Hôtel
United Kingdom / Signature FSE
Spain / Álvarez
Hungary / Kende Gastro
Czech Republic / Design Gastro

North America / BauscherHepp Inc.
United Arab Emirates / RestofairRAK
Singapore / Andy Mannhart Asia
Qatar / Royal Hospitality
Saudi Arabia / Portstores
Australia / Table Direct



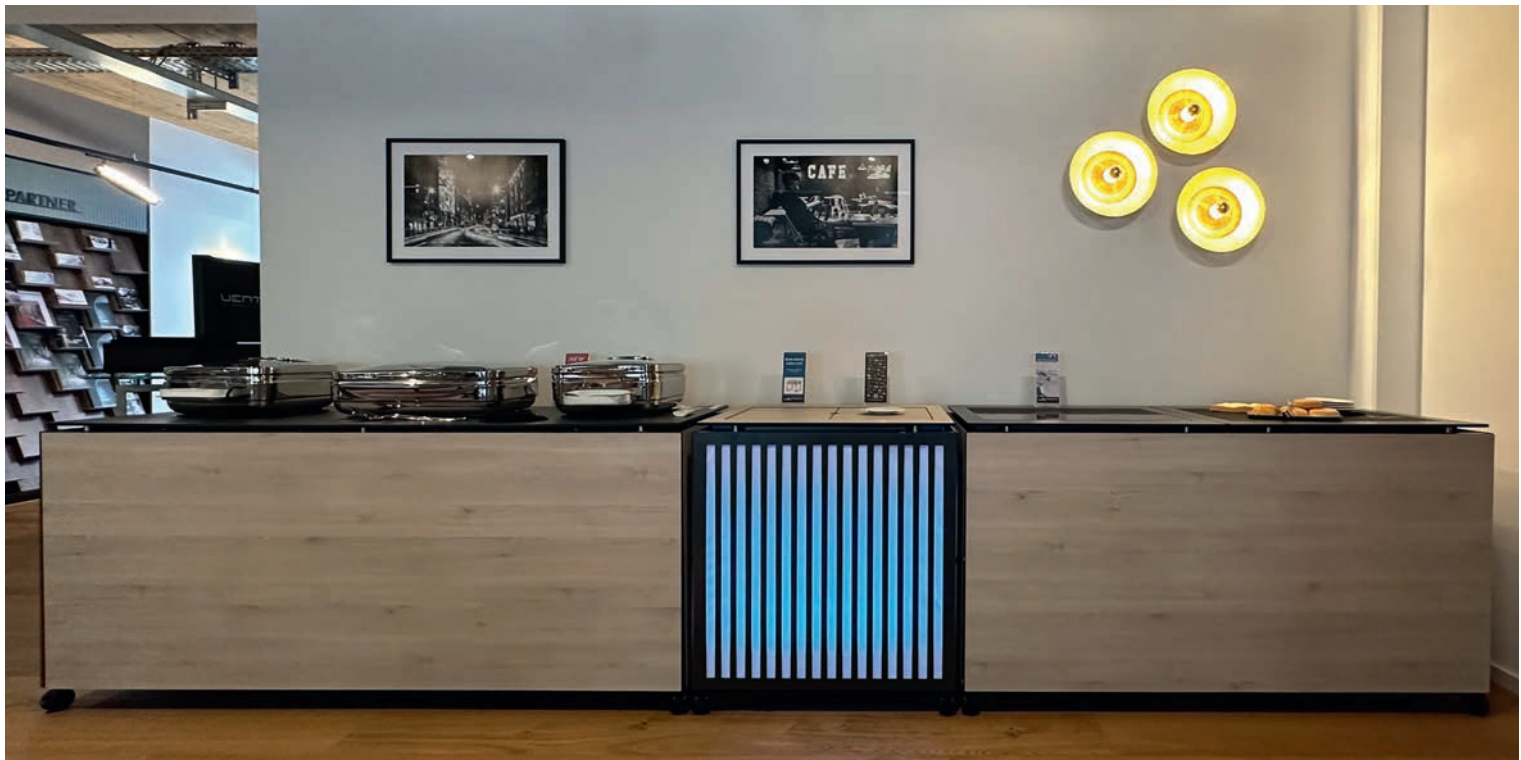

GERMANY | Munich

New equipment installed in June 2023.
STAGE_80_L with 4 x invisible induction and additional tables with COOL+HOT table-top-units.

Hotelkompetenzzentrum GmbH, Sonnenstraße 19, 85764 Oberschleißheim, GERMANY







GERMANY | Düsseldorf

Full range of VENTA equipment on two floors in a wonderful showroom atmosphere. Take advantage of many years of experience of the Autenrieb sales team in consulting and sales.

Autenrieb Gastronomy Service International GmbH, Pappelweg 2, 40489 Düsseldorf, GERMANY







USA | Raleigh, Chicago, New York

VENTA equipment on stock in Raleigh, North Carolina. BauscherHepp is our distributor for North America, Mexico and the Caribbean.



BauscherHepp Inc., 6612 Fleetwood Dr STE 104, Raleigh, NC 27612, Unites States



Textura

Excellence since 1986 - Exclusive Design since 2006

ZIEHER

The brand ZIEHER stands for innovative design in top class restaurants and the innovative gastronomy in over 90 countries.

Products made of different materials such as glass, stainless steel, solid wood, porcelain etc. and their combinations give birth to high-quality, modern tableware and buffet-systems.

This is why ZIEHER is internationally well known by its target audiences (executive floors, suites and lounges) as a modern company with the strength to create innovative products with appealing and emotional design - out of its own ideas.

Skyline

The system allows a maximum of flexibility for the most exclusive buffet presentations. The spectacular look, which is remotely reminiscent of the silhouette of skyscrapers, as well as the extensive functionality, leave nothing to be desired with this unique system.



All Zieher products from the range of buffet, wine & dine can be found at
WWW.ZIEHER.COM

STAGE_80_M/breakfast station





FRILICH
D



Worldwide | References

VENTA has designed exclusive furniture for the hotel, events and catering industry throughout the world. Our clients are based in a wide range of locations.

You can find all our clients worldwide on our website under references:

<https://ventadesign.com/references-world-wide-leading-hotels/>



Worldwide | References

7Pines Resort Ibiza
7Pines Resort Sardinia
Aberdeen Exhibition and Conference Centre
AC Hotel Berlin Humboldthain Park
AC Hotel Paris Le Bourget Airport
Accenture Innovation Centre London
Accra Marriott Hotel
Address Beach Resort Fujairah
Address Harbor Point – Dubai
Address Sky View
Adina Apartment Hotel Frankfurt Neue Oper
Adina Apartment Hotel Nuremberg
ADNH Compass
Al Baleed Resort Salalah by Anantara
Al Bustan Palace, A Ritz-Carlton Hotel
Al Messila, a Luxury Collection Resort & Spa, Doha
Alcron Hotel Prague
Allianz Deutschland AG
Aloft London Excel
Aloft Palm Jumeirah
Alois Dallmayr KG, Munich
AlRayyan Hotel Doha, Curio Collection by Hilton
Althoff Grandhotel Schloss Bensberg
Ambassadori Hotel
Amsterdam Marriott Hotel
Andaz London Liverpool Street
Andaz Prague
Arbor City Hotel London
ARCOTEL Rubin
Arena Leipzig
Armenia Marriott Hotel Yerevan
ARTE Seminar- und Konferenzhotel
Artizian Catering Limited
Assila Hotel Rocco Forte
Association of German Pfandbrief Banks
ATLANTIC Hotel Kiel
ATLANTIC Hotel Münster
Austrian Airlines
Aviator Hotel Hampshire
Axica Kongress- und Tagungszentrum
b'mine hotel Düsseldorf
Banque de France
Banyan Tree Doha At La Cigale Mushaireb
Barceló Castillo Beach Resort
Barceló Raval
BASF, Lounge Terrasse
Bay La Sun Hotel and Marina
Bayer Pharma AG
Bayerische Staatsoper
BCF ARENA
Bel-Air Country Club
Berlin Marriott Hotel
Bertelsmann SE & Co. KGaA
Big Marine Hotel
Bistro EssART, Funke Mediengruppe
Bozsik Stadion, Budapest Honvéd FC
Breidenbacher Hof, a Capella Hotel
Bristol Marriott Hotel City Centre
Bristol Marriott Royal Hotel
Brussels Marriott Hotel Grand Place
Budapest Marriott Hotel, Hungary
Bulgari Hotel Beijing
Bulgari Hotel Roma
Bulgari Hotel Tokyo
Bundespräsidialamt, Schloss Bellevue
Bürgenstock Resort
Calgary Marriott Downtown Hotel
Campus Hotel Hertenstein
Canon Deutschland GmbH
Capella Singapore
Carlo IV
CCD, The Convention Centre Dublin
Celtic Manor Resort
Cidade de Goa - IHCL SeleQtions
Circle at Paradisus Palma Real
City of Dreams
Cologne Marriott Hotel
COMP-LET Party Service Kft.
Concert Hall „Great Amber“
CONRAD Seoul
Copenhagen Marriott Hotel
Coral Level at Iberostar Selection Cancun
Corinthia Hotel London
Courtyard Amsterdam Airport
Courtyard Berlin City Center
Courtyard Brno
Courtyard Budapest City Center
Courtyard Hamburg City
Courtyard Marriott Batumi
Courtyard Paris Gare de Lyon
Courtyard Paris Roissy Charles de Gaulle Airport Hotel
Courtyard Prague City
Courtyard Riyadh Olaya
Courtyard Sarajevo
Courtyard St. Petersburg Vasilievsky
Courtyard Stockholm Kungsholmen
Crown Sydney
Crowne Plaza Copenhagen Towers
Crowne Plaza Dusseldorf - Neuss
Cummins Inc.
Cunard Line
D Maris Bay
D-Resort Šibenik
DAMAC Towers by Paramount Hotels & Resorts Dubai
Danubius Health Spa Resort Margitsziget
dbb forum berlin
DEINspeisesalon
Delta Hotels Bessborough
Delta Hotels by Marriott City Center Doha
Delta Hotels Calgary Airport In-Terminal
Der Hermannshof (Gästehaus)
Deutsche Lufthansa AG
Deutsches Historisches Museum
Dods
Doha Marriott Hotel
Dorint Maison Messmer Baden-Baden
DORMERO Hotel Berlin Ku'damm
DoubleTree by Hilton Berlin Ku'damm
DoubleTree by Hilton Novosibirsk
Dream Cruises, Genting Dream
Dubai World Trade Centre
Durango Casino and Resort
Durham Marriott Hotel Royal County
Dusit Doha Hotel
Eagle ski club
Easthampstead Park
Eichberg
Eldora AG
Empire Riverside Hotel
Enterprise Hotel
ERGO Gourmet, ERGO Group AG
EUREF-Campus Berlin
Fairmont Hotel Vier Jahreszeiten Hamburg
Fairmont Quasar Istanbul
Falkenstein Grand, Königstein
Federal Foreign Office
Fes Marriott Hotel Jnan Palace
FIFA World Football Museum
FONTANA Restaurant GmbH
Four Seasons Hotel Doha
Frankfurt Marriott Hotel
Fraser Suites Doha
Fraunhofer-Forum Berlin
Freudenberg Real Estate GmbH

Worldwide | References

Freudenberg Real Estate GmbH
Geneva Marriott Hotel
Genting Dream
German Embassy Kiev
German Embassy Moscow
German Embassy Skopje
Giardino Ascona
Gold Coast Convention and Exhibition Centre
Golf- und Land-Club Berlin Wannsee e.V.
Golfhotel Bodensee
Gothal, Liptovská Osada
Grace La Margna St. Moritz
Gran Meliá Palacio de los Duques
Gran Meliá Victoria
Grand Heritage Doha Hotel
Grand Hotel Cirta
Grand Hotel Des Bains Kempinski St. Moritz
Grand Hotel Djibloho
Grand Hotel Europe
Grand Hotel Huis ter Duin
Grand Hotel Kempinski Riga
Grand Hotel Savoia
Grand Hyatt Berlin
Grand Millennium Muscat
Grand Rostov by Hyatt Regency
Grosvenor House Suites
Grosvenor House, a Luxury Collection Hotel, Dubai
Grosvenor House, JW Marriott Hotel
Gurten Park im Grünen
Gut Brandlhof
Güterbahnhof Neubrandenburg
H10 Berlin Ku'damm
H4 Hotel Berlin Alexanderplatz
Hallenstadion Zürich
Hamad Medical Corporation
Hamburg Marriott Hotel
Hamburg Süd
Hamburger Feuerkasse
HARPA Concert Hall
HC Fribourg-Gottéron
Heidelberg Marriott Hotel
Henkel AG
Hilton at St. George's Park, Burton upon Trent
Hilton Barcelona
Hilton Brisbane
Hilton Budapest
Hilton Dubai Palm Jumeirah
Hilton Garden Inn Mannheim

Hilton Garden Inn Volgograd
Hilton Geneva Hotel and Conference Centre
Hilton Luxor Resort & Spa
Hilton Mainz
Hilton Prague
Hilton Prague Old Town
Hilton Salwa Beach Resort & Villas
Hilton Sofia
Hilton Tangier Al Houara Resort & Spa
Holiday Inn Edmonton S - Ellerslie Road
Holiday Inn Express London - Limehouse
Holiday Inn Leipzig - Günthersdorf
Holiday Inn Lubeck
Holiday Inn Munich – City Centre
Home Les Crêtes
Hotel 47°
Hotel Adlon Kempinski Berlin
Hotel Alfonso XIII, A Luxury Collection Hotel, Sevilla
Hotel am Steinplatz, Autograph Collection
Hotel Arte, Seminar- und Konferenzhotel
Hotel Arts
Hotel Astoria
Hotel Atlantic Kempinski Hamburg
Hotel Belvoir
Hotel Berlin Central District
Hotel Bristol, a Luxury Collection Hotel, Warsaw
Hotel Camiral, PGA Catalunya Resorts
Hotel Continental
Hotel Crystal
Hôtel des Horlogers
Hôtel du Léman
Hotel Fairmont Riyadh
Hotel Goldenes Rad Ulm
Hotel Hafen Hamburg
Hotel Indigo St. Petersburg, Tchaikovskogo
Hotel Kloster Haydau
Hotel Malbork by DeSilva
Hotel Maximilian's
Hotel Meilenstein
Hotel Michaelis
Hotel Neues Pastorat
Hotel NH Düsseldorf City
Hotel Passage
Hotel RIU Plaza España
Hotel Rosatsch, Pontresina
Hotel Schweizerhof Luzern
Hotel Sedartis
Hotel Vier Jahreszeiten Kempinski Munich

Hungexpo, Budapest
Hyatt Centric Gran Via Madrid
Hyatt House Dusseldorf / Andreas Quarter
Hyatt Place Taghazout Bay
Hyatt Regency Casablanca
Hyatt Regency Dar es Salaam, The Kilimanjaro
Hyatt Regency London - The Churchill
Hyatt Regency London Blackfriars
Hyatt Regency Sochi
Hyatt Regency Sofia
Hyatt Regency Zurich Airport The Circle
Iberostar Dominicana
Iberostar Grand Hotel Bavaro
Iberostar Grand Paraiso
Iberostar Rose Hall Beach
Iberostar Selection Cancun
InterContinental Bahrain
InterContinental Berlin
InterContinental Bucharest
InterContinental Doha - The City
InterContinental Dusseldorf
InterContinental Fujairah Resort
InterContinental Ljubljana
InterContinental Muscat
InterContinental San Francisco
InterContinental Tashkent
InterContinental Vienna
Internationale Stiftung Mozarteum
Irvine Marriott
Istanbul Marriott Hotel Sisli
Johannesburg Marriott Melrose Arch Hotel
Jumeirah Port Soller Hotel & Spa
JW Marriott Absheron Baku
JW Marriott Bucharest Grand Hotel
JW Marriott Chandigarh
JW Marriott Edmonton Ice District & Residences
JW Marriott Grosvenor House London
JW Marriott Hotel Ankara
JW Marriott Hotel Cairo
JW Marriott Hotel Frankfurt
JW Marriott Hotel Hong Kong
JW Marriott Hotel Singapore South Beach
JW Marriott Hotel Tripoli
JW Marriott Marquis Dubai
JW Marriott parc Vancouver
JW Marriott Venice Resort & Spa
K Hotel Douala
Kameha Suite Frankfurt

Worldwide | References

Kempinski Hotel Berchtesgaden
Kempinski Hotel Frankfurt Gravenbruch
Kempinski Seychelles Resort Baie Lazare
Kigali Marriott Hotel
Kimpton Aysla Mallorca
Kings Palace Oman
Klinik Hirslanden AG
Klostergut Paradies
Kongresshaus Zürich
Kongresshotel Potsdam
Krasnodar Marriott Hotel
Kulmhotel St. Moritz
Kultur- und Kongresszentrum Luzern
Kursaal Bern
La Ville Hotel & Suites CITY WALK, Dubai, Autogr. Col.
Lancashire Cricket Club
Lapita, Dubai Parks and Resorts, Autograph Collection
Le Méridien Barcelona
Le Méridien Hamburg
Le Méridien Piccadilly
Le Méridien Stuttgart
Leipzig Marriott Hotel
Leon's Place
lewisford group
Lindner Hotel & Residence Main Plaza
Lindner Hotel & Sporting Club Wiesensee
Lindner Hotel Am Michel
Lindner Hotel City Plaza
Linklaters LLP
London Bridge
London Marriott Hotel Grosvenor Square
London Marriott Hotel Kensington
LondonHouse Chicago, Curio Collection by Hilton
Lufthansa Seeheim GmbH
Lusso Catering
Macdonald Cardrona Hotel, Golf & Spa
Madinat Jumeirah Resort
Mainova AG
Majid Al Futtaim
Makkah Marriott Hotel Jabal Omar
Mandarin Orchard Singapore
Mandarin Oriental Barcelona
Mandarin Oriental, Washington D.C.
Marina Bay Sands
Maritim Hotel Düsseldorf
Marriott Bloom Central
Marriott Executive Apartments Addis Ababa
Marriott Hotel Al Forsan, Abu Dhabi
Marsa Malaz Kempinski, The Pearl - Doha
McAllen Country Club
ME Dubai
Me Ibiza
Media One Hotel Dubai
Meliá Alicante
Meliá Bilbao
Meliá Castilla
Meliá Costa del Sol
Meliá Frankfurt City
Meliá Palma Bay
Meliá Sevilla
Meliá Sitges
Meliá Vienna
Messe Berlin, CityCube Berlin
METZLER, B. Metzler seel. Sohn & Co. Holding AG
Milan Suite Hotel
Millennium
Millennium Place Mirfid
Millennium Stadium (Principality Stadium)
Miranda de Pedralbes
Mishcon de Reya
Mohammed V-University
Moment Cuisine
Mondrian Doha Hotel
Moor House, London Wall
Mövenpick Hotel Amsterdam City Centre
Mövenpick Hotel Basel
Mövenpick Hotel Doha
MOXY Vienna Airport
Müller-Zeiner Industrieverpackungen GmbH
Munich Marriott Hotel
Munich Marriott Hotel City West
Neuro Campus Hotel DAS MORGEN
New Century Hotel Frankfurt Offenbach
Niepce Paris Hotel, Curio Collection by Hilton
Nikki Beach Resort & Spa Dubai
Nikki Beach Resort & Spa Porto Heli
Normafa Rendezvényház Budapest
Novosibirsk Marriott Hotel
Novotel Duesseldorf City West (Seestern) Hotel
Novotel Wien Hauptbahnhof Hotel
NRW.Bank
Nujuma, a Ritz-Carlton Reserve
NYX Esperia Palace Athens
O.N.E. Hospitality Group
O2 universum
Original Sokos Hotel Vaakuna
Palais Hansen Kempinski Vienna
Palau de Congressos de Catalunya
Palazzo Versace Dubai
Paris Marriott Champs Elysees Hotel
Paris Marriott Charles de Gaulle Airport Hotel
Paris Marriott Rive Gauche Hotel & Conference Center
Park Hotel Vitznau
Park Hyatt Mallorca
Park Hyatt Paris-Vendôme
Park Hyatt Zurich
Park Inn by Radisson Amsterdam City West
Park Inn by Radisson Poznan
Pathé Theater Amersfoort
Patinoire de Malley
Pilsner Urquell International
Platz Hotel
Powerscourt Hotel Resort & Spa
Prague Marriott Hotel
Protea Hotel by Marriott Ikeja Select
Pullman Berlin Schweizerhof
Puskás Aréna
PWC PricewaterhouseCoopers
QO Amsterdam
Radisson Blu Béke Hotel, Budapest
Radisson Blu Hotel & Residences, Zakopane
Radisson Blu Hotel Reussen, Andermatt
Radisson Blu Hotel, Basel
Radisson Blu Hotel, Frankfurt
Radisson Blu Hotel, Hamburg
Radisson Blu Hotel, Hannover
Radisson Blu Hotel, Lucerne
Radisson Blu Hotel, Prague
Radisson Blu Hotel, Zurich Airport
Radisson Blu Schwarzer Bock Hotel, Wiesbaden
Radisson Collection Hotel, Berlin
Radisson Collection Hotel, Magdalena Plaza Sevilla
RAMADA Hotel Berlin Alexanderplatz
RCP North, William Henry Duncan Building
Regent Warsaw Hotel
Renaissance Amsterdam Hotel
Renaissance Barcelona Hotel
Renaissance Downtown Hotel, Dubai
Renaissance Lagos Ikeja Hotel
Renaissance Minsk Hotel
Renaissance Paris La Defense Hotel
Renaissance Paris Le Parc Trocadero Hotel
Renaissance Paris République Hotel
Renaissance Paris Vendome Hotel

Worldwide | References

Renaissance Porto Lapa Hotel
Renaissance Warsaw Airport Hotel
Renaissance Zurich Tower Hotel
Résidence Claire-Fontaine
Résidence Plantzette - EMS
Resort Mark Brandenburg
Resort Schwielowsee
Restaurant Lebenswert
Revo
Rheinhotel Dreesen
Rixos Borovoe Hotel
Robinson Club Fleesensee
ROOMERS Hotel Munich
Rosewood Abu Dhabi
Rosewood Yangon
Rotterdam Marriott Hotel
Royal Canberra Golf Club
Royal College of Physicians
Royal Hideaway Corales Suites
Royal Palace Riyadh
Royal Savoy Lausanne
Scandic Berlin Kurfürstendamm
Scandic Berlin Potsdamer Platz
Scandic Frankfurt Hafepark
Scandic Frankfurt Museumsufer
Scandic Hamburg Emporio
Scenic Eclipse II
Schloss Bellevue
Schloss Benkhausen
Schloss Fuschl Resort & Spa
Searcys at the Gherkin
Seehotel Zarrentin
Seminarhotel Bocken
Setif Algeria Courtyard by Marriott
Seven Visions The Dvin Hotel & Places
Shangri-La Hotel Doha
Shaza Doha
Sheraton Berlin Grand Hotel Esplanade
Sheraton Bratislava Hotel
Sheraton Frankfurt Airport Hotel and Conference Center
Sheraton Frankfurt Congress Hotel
Sheraton Grand Doha Resort & Convention Hotel
Sheraton Grand Hotel & Spa, Edinburgh
Sheraton Munich Arabellapark Hotel
Sheraton Nur-Sultan Hotel
Sheraton Oman
Sheraton Riyadh Hotel & Towers
Sheraton Sopot Hotel

Sheraton Towers Singapore
Sheraton Warsaw Hotel
Siau Ibiza Hotel
SIDE Hotel
Singapore Airlines
Skopje Marriott Hotel
SLS Dubai Hotel & Residences
Sofitel Frankfurt Opera
Sofitel Hotel München Bayerpost
Sofitel Legend The Grand Amsterdam
St. Pancras Renaissance London
Staatlicher Hofkeller
Stademos Mediterranean Beach Hotel
Stadtsparkasse Düsseldorf
Starling Hotel Geneva
Steigenberger Airport Hotel, Frankfurt
Steigenberger Bellerive au Lac
Steigenberger Frankfurter Hof
Steigenberger Graf Zeppelin
Steigenberger Hotel Am Kanzleramt, Berlin
Steigenberger Hotel Bad Homburg
Steigenberger Hotel de Saxe
Steigenberger Hotel Hamburg
Studierendenwerk Stuttgart
Stuttgart Marriott Hotel Sindelfingen
Sugar Beach, a Viceroy Resort
Swiss Life Karriere-Campus Hannover
Swissôtel The Bosphorus
Symphony Style Hotel, Kuwait
Taj Dubai
Taj Exotica Resort & Spa, The Palm, Dubai
Taj Mahal, New Delhi
Taj Palace New Delhi, India
Taj Resort & Convention Centre, Goa
Taj Skyline, Ahmedabad
Taj Wellington Mews, Chennai
Taylor Wessing
Tennis-Club 1899 e. V. Blau-Weiss
The Address Boulevard Dubai
The Address Downtown Dubai
The Address Dubai Mall
The Address Dubai Marina
The Address Montgomerie Dubai
The Alexander, a Luxury Collection Hotel, Yerevan
The Alpina Gstaad
The American Club, Singapore
The Balmoral Hotel Edinburgh, UK
THE BVLGARI HOTEL LONDON

The Capitol Kempinski Hotel Singapore
The Carlton Hotel
The Charles Hotel
The Dunloe Hotel & Gardens
The Europe Hotel & Resort
THE FONTENAY Hamburg
The H Dubai
The ICC Birmingham, UK
The ICON Hotel & Lounge
The J.M. Smucker Co.
The Joule
The Lake Spa Resort
The Landmark London
The Langham, London
The Lapa Park Hotel
The London EDITION
The Parkgate Hotel
The President Hotel Prague
The Ritz-Carlton Riyadh, Saudi Arabia
The Ritz-Carlton, Almaty
The Ritz-Carlton, Astana
The Ritz-Carlton, Baku
The Ritz-Carlton, Berlin
The Ritz-Carlton, Budapest
The Ritz-Carlton, Doha
The Ritz-Carlton, Dubai
The Ritz-Carlton, Herzliya
The Ritz-Carlton, Macau
The Ritz-Carlton, Moscow
The Ritz-Carlton, Naples
The Ritz-Carlton, St. Thomas
The Ritz-Carlton, Vienna
The Ritz-Carlton, Washington, D.C.
The Ritz-Carlton, Wolfsburg
The Royal Hashemite Court
The Savoy
The St. Regis Cairo
The St. Regis Doha
The St. Regis Macao, Cotai Central
The St. Regis Red Sea Resort
The Torch Doha
The Westin Grand Frankfurt
The Westin Hamburg
Tirana Marriott Hotel
Trans World Hotel Auefeld, Hann. Münden
Trans World Hotel Columbus
Trans World Hotel Kranichhöhe, Much
Traube Tonbach

Worldwide | References

Union Investment
Vienna House Andel's Prague
Vienna House Andel's Berlin
Vienna Marriott Hotel
Villa Hammerschmidt
Villa Wellenrausch Lübeck
Volksbank Ruhr Mitte eG
Voronezh Marriott
Voronezh Marriott
W Doha Hotel & Residences
W Hotel Amman
W Hotel Amsterdam
W Melbourne
W/Ray Construction Pte Ltd
Waldhaus Flims, Alpine Grand Hotel & Spa
Warner Hotels - Holme Lacy House
Warsaw Marriott Hotel
Wasserturm Hotel Cologne Curio Collection
Wellness Hotel Vista
Widder Hotel
Winton Capital Management Limited
Wyndham Garden Lahnstein Koblenz
Wyndham Grand Regency Doha
Yotel Glasgow
Zonar Zagreb
Zurich Marriott Hotel

Worldwide | References | Cities

Aberdeen
Abu Dhabi
Abu Samra
Accra
Addis Ababa
Agadir
Ahmedabad
Al Aqah, Fujairah
Al Baleed Salalah
Alicante
Almaty
Amersfoort
Amman
Amsterdam
Amsterdam
Andermatt
Ankara
Aschaffenburg
Ascona
Astana
Athen
Augsburg
Bad Homburg
Baden-Baden
Bahrain
Baie Lazare Mahé Island
Baku
Barcelona
Basel
Bassecourt
Batumi
Beaufort, Killarney, Co. Kerry
Beijing
Benkhaisen
Berchtesgaden
Bergisch Gladbach, Cologne
Berlin
Bern
Bilbao
Birmingham
Bonn
Bratislava
Brisbane
Bristol
Brno
Broadbeach, Queensland
Brussels
Bucharest

Budapest
Burton upon Trent
Cairo
Caldes de Malavella, Girona
Calgary
Cancún
Canyamel, Mallorca
Cardiff
Casablanca
Castillo Caleta de Fuste, Las Palmas
Chandigarh
Chicago, Illinois
Cologne
Columbus, Indianapolis
Constantine
Copenhagen
Dallas
Dar es Salaam
Djibloho
Doha
Dolní Morava
Douala
Dresden
Dubai
Dublin
Durham
Dusseldorf
Edinburgh
Edmonton
EL Sittard
Essen
Farnborough, Hampshire
Fes
Fleesensee, Göhren-Lebbin
Flims
Frankfurt
Fribourg
Fujairah
Fuschlsee-Salzburg
Gelsenkirchen
Geneva
Genova
Glasgow
Grimisuat
Gstaad
Güterslöh
Hamburg
Hann. Münden

Hannover
Heidelberg
Heiligenhaus
Helsinki
Hereford
Herzliya
Hong Kong
Horgen
Hurst, Berkshireshire
Ibiza
Ibiza, Santa Eulalia del Río
Ikeja GRA Lagos
Ikeja, Lagos
Ilfracombe
Irvine
Istanbul
Jeddah
Jerewan
Johannesburg
Jongny s/ Vevey, Vaud
Kiel
Kiev
Kigali
Killarney
Königstein, Frankfurt
Konstanz
Krasnodar
Kuwait City
Lahnstein, Rhineland-Palatinate
Langenthal
Lausanne
Le Brassus
Leipzig
Liepaja
Limassol
Liptovská Osada
Liverpool
Ljubljana
London
Los Angeles
Lübeck
Lucerne
Ludwigshafen
Luxor
Macau
Madrid
Mainz
Makkah

Worldwide | References | Cities

Málaga
Malbork
Mallorca
Manchester
Manila
Mannheim
Marmaris, Mugla
McAllen, Texas
Melbourne
Milano
Minsk
Mirdif, Dubai
Montego Bay
Montreux
Morschen
Moscow
Much
Munich
Münster
Muscat
Naples, Florida
Neubrandenburg
Neuruppin
Neuss
New Delhi
Noordwijk
Novosibirsk
Novosibirsk
Nuremberg
Nur-Sultan
Obbürgen/Lucerne
Oberwaltersdorf
Olten
Orrville, Ohio
Palma de Mallorca
Panaji, Goa
Paris
Peebles
Pontresina
Port Soller, Mallorca
Porto
Porto Heli
Potsdam
Poznan
Prague
Prague
Prilly
Punta Cana

Rabat
Red Sea Resort
Reykjavik
Riga
Riviera Maya
Riyadh
Rome
Rostov-on-Don, Rostov Oblast
Rotterdam
Saalfelden
Salzburg
San Francisco
Sarajevo
Sardinia
Saskatchewan
Schlatt
Seeheim
Seengen
Seligenstadt
Seoul
Setif
Seville
Shchuchinsk, Akmolá region
Šibenik
Sierre
Singapore
Skopje
Sochi
Sofia
Sopot
Soufriere, Saint Lucia
Sovata
Spring Valley
Springe-Völkxen
St. Moritz
St. Petersburg
St. Thomas, U.S. Virgin Islands
Stockholm
Stuttgart
Sydney
Tangier
Tashkent
Tbilisi
Tenerife
Thalwil
Tharamani, Chennai, Tamil Nadu
Tirana
Tokyo

Tonbach
Tripoli
Ulm
Ummahat Island, Red Sea Resort
Usk Valley, London
Vancouver
Venice
Vienna
Vilamoura, Algarve
Vitznau
Volgograd
Voronezh
Warsaw
Washington, D. C.
Weggis
Weinheim
Weißensberg
Werder/Havel
Westerburg/Westerwald
Wiesbaden
Wokingham
Wolfsburg
Würzburg
Yangon
Yarralumla, Canberra
Yerevan
Zagreb
Zakopane
Zarrentin am Schaalsee
Zurich

Worldwide | References | Countries

Albania	Philippines
Algeria	Poland
Armenia	Portugal
Australia	Qatar
Austria	Republic of Belarus
Azerbaijan	Romania
Bahrain	Russia
Belgium	Rwanda
Bosnia Herzegovina	Saudi Arabia
Bulgaria	Seychelles
Cameroon	Singapore
Canada	Slovakia
China	South Africa
Croatia	South Korea
Cyprus	Spain
Czech Republic	St. Lucia
Denmark	Sweden
Dominican Republic	Switzerland
Egypt	Tansania
Equatorial Guinea	Turkey
Ethiopia	UAE United Arab Emirates
Finland	UK, Great Britain
France	UK, Ireland
Georgia	UK, Scotland
Germany	Ukraine
Ghana	USA
Greece	Uzbekistan
Hong Kong/China	
Hungary	
Iceland	
India	
Israel	
Italy	
Jamaica	
Japan	
Jordan	
Kazakhstan	
Kuwait	
Latvia	
Libya	
Macedonia	
Mexico	
Morocco	
Myanmar	
Netherlands	
Nigeria	
North Macedonia	
Oman	

www.ventadesign.com