

LISTINO PREZZI PRICE LIST 09.2022

NUOVI PRODOTTI DA PAGINA 181 - NEW PRODUCTS FROM PAG.181

LAMPADE RISCALDANTI / STERLIZZATORI UNIVERSALI / CARRELI E MOBILI DI SERVIZIO IN LEGNO

HEATING LAMPS / UNIVERSAL UV STERILISERS / WOODEN SERVICE TROLLEYS AND CABINETS

CATALOGUE&PRICE.2022

MULTISERVICE

fimar
group

forcar[®]
MULTISERVICE







Storia della Forcar

HISTORY
HISTOIRE
GESCHICHTE

IT

Forcar srl nasce da un'idea di Oriano Tamburini che dopo aver creato il brand Fimar decide di ampliare il ventaglio di prodotti dedicati alla ristorazione e non solo, con una linea di attrezzature professionali per il servizio in sala. Nasce nel 1994 la **Forcar Multiservice**: una linea di carrelli in acciaio e in legno, mobili di servizio, carrelli per alberghi, articoli per la pizzeria e la macelleria, bacinelle e vaschette, fino a pattumiere, portarifiuti e articoli per la pulizia professionale. Una gamma sempre più ampia grazie all'apertura nel 2019 di una nuova area logistica di oltre 17.000 m² a Villa Verucchio.

EN

Forcar srl was born from an idea of Oriano Tamburini who, after creating the brand Fimar, decided to expand the range of products dedicated to catering professionals and other sectors, with a line of professional equipment for waiting service. In 1994 **Forcar Multiservice** was founded: a line of steel and wooden trolleys, service furniture, trolleys for hotels, items for pizzerias and butchers, containers and trays, up to dustbins, waste bins and items for the professional cleaning. A range now increasingly wide thanks to the opening in 2019 of a new logistics area of over 17,000 m² located in Villa Verucchio.

FR

Forcar srl est née de l'idée d'Oriano Tamburini qui, après avoir créé la marque Fimar, a décidé de compléter la gamme de produits destinés à la restauration en créant un équipement professionnel pour le service en salle. En 1994 naît **Forcar Multiservice**: une ligne de chariots en acier et en bois, meubles de service, chariots pour hôtels, articles pour pizzerias et boucheries, bacs et plateaux, poubelles et articles pour le nettoyage professionnel. Une offre en constante évolution grâce à l'ouverture en 2019 d'une nouvelle zone logistique de plus de 17.000 m² à Villa Verucchio.















DE

Forcar srl wurde aus einer Idee von Oriano Tamburini geboren, nach der Gründung der Marke Fimar wollte er die Bandbreite der Produkte für die Gastronomie und verwandte Bereiche, mit einer Reihe von professionellen Geräten für den Tischservice erweitern. 1994 wurde **Forcar Multiservice** gegründet: eine Produktlinie von Stahl- und Holzwagen, Servicemöbeln, Wagen für Hotels, Artikeln für Pizzerien und Metzgereien, Behältern und Blechen bis hin zu Müllbehältern, Mülltonnen und Artikeln für die professionelle Reinigung. Ein zunehmend breiteres Angebot dank der Eröffnung im Jahr 2019 einer neuen Logistikanlage von über 17.000 m² in Villa Verucchio.



ICONE

ICONS
ICÔNES
SYMBOLE

	IT	EN	FR	DE
	INFORMAZIONI	INFORMATION	INFORMATION	INFO
	NUMERO PIANI	NUMBER OF SHELVES	NOMBRE D'ÉTAGÈRES	STELLFLÄCHENANZAHL
	CARICO MASSIMO	MAXIMUM LOAD	CHARGE MAXIMALE	MAXIMALE BELASTUNG
	DIMENSIONI MACCHINA	MACHINE DIMENSIONS	DIMENSIONS DES MACHINES	MASCHINEN ABMESSUNGEN
	POTENZA	POWER	PUISSANCE	LEISTUNG
	PIASTRE/FUOCHI	PLATES/BURNERS	CUSINIÈRES/BRÛLEURS	KOCHFLÄCHEN/KOCHSTELLEN
	DIMENSIONI DEL PIANO DI LAVORO	DIMENSIONS OF THE WORKTOP	DIMENSIONS DU PLAN DE TRAVAIL	ABMESSUNGEN DER ARBEITSPLATTE
	NUMERO VASCHE	NUMBER OF BOWLS	NOMBRE DE CUVES	ANZAHL DER WANNEN
	ALIMENTAZIONE MONOFASE	SINGLE-PHASE POWER SUPPLY	ALIMENTATION MONOPHASÉE	EINPHASIGE STROMVERSORGUNG
	TEMPERATURA DI LAVORO	WORKING TEMPERATURE	TEMPÉRATURE DE FONCTIONNEMENT	BETRIEBSTEMPERATUR
	TIPO DI GAS	TYPE OF GAS	TYPE DE GAZ	GASTYP
	NUMERO DI TEGLIE	NUMBER OF TRAYS	NOMBRE DE PLAQUES	ANZAHL DER BLECHE
	NUMERO PIATTI	NUMBER OF PLATES	NOMBRE DE PLATS	ANZAHL DER TELLER
	CAPACITÀ DEL CONTENITORE	CONTAINER CAPACITY	CAPACITÉ DU CONTENANT	BEHÄLTERKAPAZITÄT



INDICE

INDEX
TABLE DES MATIÈRES
INHALT

CATEGORIE	IT	EN	FR	DE	
CARRELLI E MOBILI DI SERVIZIO IN LEGNO	CARRELLI GUÉRIDON	GUÉRIDON TROLLEYS	CHARIOTS GUÉRIDON	GUÉRIDON WAGEN	13
WOODEN SERVICE TROLLEYS AND SERVING FURNITURE	CARRELLI DI SERVIZIO IN LEGNO	WOODEN SERVICE TROLLEYS	CHARIOTS DE SERVICE EN BOIS	SERVIERWAGEN AUS HOLZ	15
CHARIOTS ET MEUBLES DE SERVICE EN BOIS	CARRELLI FLAMBÈ	FLAMBÈ TROLLEYS	CHARIOTS FLAMBÉS	FLAMBÉ WAGEN	25
SERVIERWAGEN UND SERVICEMÖBEL AUS HOLZ	MOBILI DI SERVIZIO IN LEGNO	WOODEN SERVING FURNITURE	MEUBLES DE SERVICE EN BOIS	SERVICEMÖBEL AUS HOLZ	27
CARRELLI DI SERVIZIO IN ACCIAIO INOX AISI 304	CARRELLI DI SERVIZIO IN ACCIAIO INOX E RIPIANI IN NOBILITATO	STAINLESS STEEL SERVICE TROLLEYS WITH SHELVES MADE OF MELAMINE	CHARIOTS DE SERVICE ET ÉTAGÈRES EN ACIER INOX EN MÉLAMINE	SERVIERWAGEN AUS EDELSTAHL MIT ABLAGEN AUS MELAMINHARZ	37
SERVICE TROLLEYS IN STAINLESS STEEL AISI 304	CARRELLI DI SERVIZIO IN ACCIAIO INOX	STAINLESS STEEL SERVICE TROLLEYS	CHARIOTS DE SERVICE EN ACIER INOX	SERVIERWAGEN AUS EDELSTAHL	39
CHARIOTS DE SERVICE EN ACIER INOX AISI 304	CARRELLI DI SERVIZIO MULTIUSO IN PLASTICA	MULTIPURPOSE PLASTIC SERVICE TROLLEYS	CHARIOTS POLYVALENTE EN PLASTIQUE	MEHRZWECK-SERVICEWAGEN AUS KUNSTSTOFF	49
SERVIERWAGEN AUS EDELSTAHL AISI 304	CARRELLI REFRIGERATI IN LEGNO	WOODEN REFRIGERATED TROLLEYS	CHARIOTS RÉFRIGÉRÉS EN BOIS	GEKÜHLTE SERVIERWAGEN AUS HOLZ	51
CARRELLI ED ESPOSITORI REFRIGERATI E TERMICI IN LEGNO	ESPOSITORI REFRIGERATI IN LEGNO	WOODEN REFRIGERATED DISPLAYS	VITRINES RÉFRIGÉRÉES EN BOIS	GEKÜHLTE VITRINE AUS HOLZ	54
WOODEN THERMAL AND REFRIGERATED TROLLEYS AND DISPLAYS	CARRELLI TERMICI A BAGNOMARIA IN LEGNO	WOODEN BAIN-MARIE TROLLEYS	CHARIOTS CHAUDES BAIN-MARIE EN BOIS	BAIN-MARIE WAGEN AUS HOLZ	57
CHARIOTS ET VITRINES RÉFRIGÉRÉS ET CHAUFFÉS EN BOIS	ESPOSITORI TERMICI A BAGNOMARIA IN LEGNO	WOODEN HEATED BAIN-MARIE DISPLAYS	VITRINES CHAUDES BAIN-MARIE EN BOIS	BEHEIZTE BAIN-MARIE VITRINE AUS HOLZ	61
GEKÜHLTE UND BEHEIZTE SERVIERWAGEN UND VITRINEN AUS HOLZ	ESPOSITORI IN LEGNO NEUTRO	DISPLAYS IN NEUTRAL WOOD	VITRINES EN BOIS NEUTRE	AUFSATZVITRINEN AUS NEUTRALEM HOLZ	64
	CARRELO TERMICO, IDEALE PER BOLLITI E ARROSTI	HEATED TROLLEYS, IDEAL FOR BOILED AND ROASTED MEATS	CHARIOTS CHAUFFANTS, IDÉAUX POUR BOUILLIR ET RÔTIR	BEHEIZTE SERVIERWAGEN, IDEAL FÜR GEKOCHTES UND GEBRATENES FLEISCH	64
	MENSOLE IN LEGNO PER UNIONE	CONNECTION WOODEN SHELF	ÉTAGÈRES EN BOIS POUR RACCORDS	VERBINDUNGSREGALE AUS HOLZ	66
CARRELLI REFRIGERATI E TERMICI, VASCHE DA INCASSO, DISTRIBUTORI PRIMA COLAZIONE, IN ACCIAIO INOX	VASCHE REFRIGERATE IN ACCIAIO INOX (DROP-IN)	STAINLESS STEEL REFRIGERATED BOWLS (DROP-IN)	CUVES RÉFRIGÉRÉES EN ACIER (A POSER)	KÜHLWANNEN AUS EDELSTAHL (DROP-IN)	69
REFRIGERATED AND HEATED TROLLEYS, BUILT-IN BOWLS, BREAKFAST DISPENSERS, MADE OF STAINLESS STEEL	VASCHE TERMICHE A BAGNOMARIA IN ACCIAIO INOX	STAINLESS STEEL HEATED BAIN-MARIE BOWLS	CUVES BAIN-MARIE EN ACIER INOX	BAIN-MARIE HEIZWANNEN AUS EDELSTAHL	70
CHARIOTS RÉFRIGÉRÉS ET CHAUFFÉS, BACS INTÉGRÉS, DISTRIBUTEURS DE PETIT DÉJEUNER, EN ACIER INOX	CARRELLI REFRIGERATI IN ACCIAIO INOX	REFRIGERATED STAINLESS STEEL TROLLEYS	CHARIOTS RÉFRIGÉRÉS EN ACIER INOX	GEKÜHLTE SERVIERWAGEN AUS EDELSTAHL	71
	CARRELLI TERMICI IN ACCIAIO INOX	HEATED STAINLESS STEEL TROLLEYS	CHARIOTS CHAUFFANTS EN ACIER INOX	BEHEIZTE SERVIERWAGEN AUS EDELSTAHL	72
GEKÜHLTE UND BEHEIZTE SERVIERWAGEN, EINGEBAUTE BEHÄLTER, FRÜHSTÜCKSSPENDER, AUS EDELSTAHL	DISTRIBUTORI PRIMA COLAZIONE IN ACCIAIO INOX	STAINLESS STEEL BREAKFAST DISPENSERS	DISTRIBUTEURS DE PETIT DÉJEUNER EN ACIER INOX	FRÜHSTÜCKSSPENDER SERVIERWAGEN AUS EDELSTAHL	80

CATEGORIE	IT	EN	FR	DE	
ELEMENTI RISCALDANTI E VETRINE NEUTRE	TAVOLE CALDE	HEATED TABLES	TABLES CHAUDES	BEHEIZTE TISCHE	83
	PIANI CALDI	HEATED TOPS	PLANS DE TRAVAIL CHAUDS	BEHEIZTE ARBEITSFLÄCHE	86
HEATING ELEMENTS AND NEUTRAL DISPLAYS	LAMPADE A RAGGI INFRAROSSI	INFRARED LAMPS	LAMPES INFRAROUGES	INFRAROT-LAMPEN	87
	VETRINE RISCALDANTI	HEATED DISPLAYS	VITRINES CHAUFFÉES	BEHEIZTE VITRINEN	90
ELÉMENTS CHAUFFANTS ET VITRINES NEUTRES	VETRINE NEUTRE	NEUTRAL DISPLAYS	VITRINES NEUTRES	NEUTRALE VITRINEN	91
	MOBILETTI SCALDAPIAZZI	PLATES HEATING CABINETS	ARMOIRES CHAUFFE-PLATS	TELLERWÄRMER	94
HEIZELEMENTE UND NEUTRALE VITRINEN	VETRINE RISCALDANTI CON GRIGLIE	HEATED DISPLAY CASES WITH GRIDS	VITRINES CHAUFFÉES AVEC GRILLES	BEHEIZTE VITRINEN MIT GITTER	95
	CARRELLI PORTAVASSOI GN	GN TRAY TROLLEYS	CHARIOTS À PLATEAUX GN	SERVIERWAGEN FÜR GN PLATTEN	97
CARRELLI PER LA CUCINA	CARRELLI PORTAVASSOI UNIVERSALI	UNIVERSAL TRAY TROLLEYS	CHARIOTS À PLATEAUX UNIVERSELS	UNIVERSAL SERVIERWAGEN	100
KITCHEN TROLLEYS	CARRELLI PORTATEGLIE GN	GASTRONOM GN PANS TROLLEYS	CHARIOTS À PLAQUES GN	SERVIERWAGEN FÜR GASTRONOMIE GN BLECHE	102
CHARIOTS POUR LA CUISINE	CARRELLI PORTATEGLIE PER PASTICCERIA	PASTRY PANS TROLLEY	CHARIOTS POUR PLAQUES DE PÂTISSERIE	SERVIERWAGEN FÜR KONDI TOREI BLECHE	104
KÜCHENWAGEN	PORTAPIATTI DA BANCO, PORTAPIATTI DA PARETE E CARRELLI	TABLE TOP PLATE RACK, WALL PLATE RACK AND TROLLEYS	ÉTAGERE À ASSIETTES DE TABLE, PORTE-ASSIETTES À MURO ET CHARIOTS	TISCH-TELLERSTÄNDER, WANDTELLERHALTER. UND TELLERWAGEN	107
CARRELLI PORTAPIATTI E CESTELLI	CARRELLI PORTAPIATTI ARMADIATI	CABINET PLATE TROLLEYS	CHARIOTS PORTE-ASSIETTES SUR ÉLÉMENT FERMÉ	TELLERWAGEN MIT SCHRANKELEMENT	110
	CARRELLI PORTAPIATTI RISCALDATI	HEATED PLATE STORAGE TROLLEYS	CHARIOTS CHAUFFÉS À ASSIETTES	BEHEIZTE TELLERWAGEN	111
PLATE AND BASKETS TROLLEYS	CARRELLI PORTAPIATTI REFRIGERATI	REFRIGERATED PLATE STORAGE TROLLEYS	CHARIOTS RÉFRIGÉRÉS À ASSIETTES	GEKÜHLTE TELLERWAGEN	112
CHARIOTS POUR PANIERS ET ASSIETTES	CARRELLI PORTAPIATTI PER TRASPORTO E RITIRO	PLATES TRANSPORT AND COLLECTION TROLLEYS	CHARIOTS DE COLLECTE, DE DISTRIBUTION ET DE STOCKAGE DE PLATEAUX	WAGEN ZUM SAMMELN, VERTEILEN UND LAGERN VON TABLETTS	113
SERVIERWAGEN FUER TELLER UND KÖRBE	SCOLAPIATTI E BICCHIERI	PLATE AND GLASSES DRAINER	ÉGOUTTOIR POUR VERRES ET ASSIETTES	HÄNGE-ABTROPFER FÜR TELLER UND GLÄSER	113
	CARRELLI PORTACESTELLI	BASKET TROLLEYS	CHARIOT À PANIERS	KORBWAGEN	114
CARRELLI PORTACASSETTE PER IMPASTI PIZZA	TROLLEY FOR PIZZA DOUGH CONTAINERS	CHARIOT À BACS POUR PÂTE À PIZZA	WAGEN FÜR PIZZATEIGBEHÄLTER	116	
CESTELLI PER LAVASTOVILIE	DISHWASHER BASKETS	PANIERS POUR LAVE-VAISSELLE	KÖRBE FÜR GESCHIRRPÜLER	117	
CARRELLI E ARTICOLI PER IL SERVIZIO IN CAMERA	CARRELLI PER LA COLAZIONE	BREAKFAST TROLLEYS	CHARIOTS DE PETIT DÉJEUNER	FRÜHSTÜCKSWAGEN	119
	CARRELLI PORTAVALIGIE E PORTABITI	LUGGAGE TROLLEYS AND CLOTHES RACKS	CHARIOTS À BAGAGES ET PORTE-VÊTEMENTS	KÖFFERWAGEN UND KLEIDERSTÄNDER	121
TROLLEYS AND EQUIPMENT FOR ROOM SERVICE	REGGI VALIGIE	LUGGAGE HOLDER	SUPPORTS DE BAGAGES	KOFFERTRÄGER	125
CHARIOTS ET ARTICLES POUR LE ROOM SERVICE	CARRELLI PER TRASPORTO PESANTE	TROLLEYS FOR HEAVY TRANSPORT	CHARIOTS POUR CHARGES LOURDES	WAGEN FÜR DEN SCHWERTRANSPORT	126
WAGEN UND AUSTRÜSTUNG FÜR DEN ZIMMERSERVICE	ASTA DELIMITA CORSIA	RETRACTABLE BARRIERS	DÉLIMITEUR DE ZONE	BEGRENZUNG	127
	MACCHINE PULISCI SCARPE	SHOE CLEANER MACHINE	MACHINE DE NETTOYAGE DE CHAUSSURES	SCHUHPUTZMASCHINE	129

CATEGORIE	IT	EN	FR	DE	
CARRELLI PORTABIANCHERIA, RIFORNIMENTO FRIGOBAR, PULIZIA E MULTIUSO LAUNDRY, MINIBAR, CLEANING AND MULTI-PURPOSE TROLLEYS CHARIOTS À LINGE, RECHARGE MINIBAR, NETTOYAGE ET POLYVALENT WÄSCHEREI-, MINIBAR-, REINIGUNG- UND MEHRZWECKWAGEN	CARRELLI PORTABIANCHERIA	LAUNDRY TROLLEYS	CHARIOTS À LINGE	WÄSCHEWAGEN	131
	CARRELLI PER RIFORNIMENTO FRIGOBAR	TROLLEYS FOR MINI-BAR REFUELLING	CHARIOTS DE REMPLISSAGE POUR MINIBARS	WAGEN FÜR DIE MINIBARFÜLLUNG	134
	CESTONE E CARRELLI CON CESTO PER BIANCHERIA	BASKET AND TROLLEYS WITH LAUNDRY BASKET	PANIERI ET CHARIOTS AVEC PANIER À LINGE	KORB UND WAGEN MIT WÄSCHEKORB	135
	CARRELLI PER PULIZIA	CLEANING TROLLEYS	CHARIOTS DE NETTOYAGE	REINIGUNGSWAGEN	136
	CARRELLO MULTIUSO IN PLASTICA	MULTI-PURPOSE PLASTIC TROLLEY	CHARIOT POLYVALENT EN PLASTIQUE	MEHRZWECK-KUNSTSTOFFWAGEN	140
ARTICOLI VARI PER LA MACELLERIA ITEMS FOR THE MEAT PROCESSING ARTICLES POUR LA TRANSFORMATION DE LA VIANDE ARTIKEL FÜR DIE FLEISCHVERARBEITUNG	LAVAMANI	HAND WASHER	LAVE-MAINS	HANDWÄSCHER	143
	STERILIZZATORI ELETTRICI PER COLTELLI	ELECTRIC STERILIZERS FOR KNIVES	DISPOSITIFS ÉLECTRIQUES DE DÉSINFECTION POUR COUTEAUX	ELEKTRISCHE ENTKEIMUNGSGERÄTE FÜR MESSER	145
	GREMBIULI E GUANTI	APRONS AND GLOVES	TABLIERS ET GANTS	SCHÜRZEN UND HANDSCHUHE	146
	CEPPI	BUTCHER BLOCKS	BLOCS DE BOUCHERIE	METZGERBLOCKS	147
	TAGLIERI E RASCHIETTO	CUTTING BOARDS AND SCRAPER	PLANCHES À DÉCOUPER ET RACLOIR	SCHNEIDEBRETTER UND ABSTREIFER	149
	SCAFFALATURA MODULARE	MODULAR SHELVING	RAYONNAGE MODULAIRE	MODULAR REGALE	150
	ELETTROINSETTICIDI	ELECTRO-INSECTICIDES	ELECTRO-INSECTICIDES	ELEKTROINSEKT-KILLER	151
ATTREZZATURA PER LA COLAZIONE BREAKFAST EQUIPMENT ÉQUIPEMENT DE PETIT-DÉJEUNER FRÜHSTÜCKSAUSRÜSTUNG	CHAFING DISHES	CHAFING DISHES	CHAFING DISHES	CHAFING DISHES	153
	ZUPPIERA ELETTRICA	ELECTRIC SOUP TUREEN	SOUPIÈRE ÉLECTRIQUE	ELEKTRISCHE SUPPENSCHÜSSEL	156
	DISTRIBUTORI CAFFÈ, BEVANDE E CEREALI	COFFEE, DRINKS AND CEREALS DISPENSERS	DISTRIBUTEURS DE CAFÉ, DE BOISSONS ET DE CÉRÉALES	KAFFEE-, GETRÄNKE- UND MÜSLISPENDER	156
	FORNELLO FLAMBÈ	FLAMBÉ COOKER	CUISINIÈRE FLAMBÉE	FLAMBÉ GASHERD	158
	PADELLA FLAMBÈ	FLAMBÉ PAN	CASSEROLE À FLAMBER	FLAMBIERPANNE	158
ARTICOLI VARI PER CUCINA E PIZZERIA ITEMS FOR COOKING AND PIZZERIA ARTICLES POUR LA CUISINE ET POUR LA PIZZERIA KOCH- UND PIZZERIAARTIKEL	BACINELLE, TEGLIE, VASCHE PER GELATO, VASSOI, APRISCATOLE, MORSO PER PROSCIUTTO, SPATOLE, PALETTE, PINZE, ROTELLE, TAGLIERI, CONTENITORI IMPASTI PER PIZZA, BILANCE	CONTAINERS, PANS, ICE CREAM CONTAINERS, TRAYS, CAN OPENERS, HAM CLAMPS, SPATULAS, SLIDES, CLAMPS, ROLLS, CHOPPING BOARDS, PIZZA DOUGH CONTAINERS, SCALES	BACS, PLAQUES, BACS À CRÈME GLACÉE, PLATEAUX, OUVRE-BOÎTES, OUVRE-BOÎTES, ÉTAU À JAMBON, SPATULES, PALETTES, PINCES, ROUES, PLANCHES À DÉCOUPER, RÉCIPIENTS À PÂTE DE PIZZA, BALANCES	BEHÄLTER, BLECHE, EISBEHÄLTER, SCHALEN, DOSENÖFFNER, SCHINKENKLAMMERN, SPATEL, SCHAUFELN, KLAMMERN, ROLLEN, SCHNEIDEBRETTER, PIZZATEIGBEHÄLTER, WAAGEN	161
PATTUMIERE-PORTARIFIUTI GARBAGE AND DUST BINS POUBELLES MÜLL- UND ABFALLBEHÄLTER	PATTUMIERE-PORTARIFIUTI	GARBAGE AND DUST BINS	POUBELLES	MÜLL- UND ABFALLBEHÄLTER	177
	CONDIZIONI GENERALI DI VENDITA	GENERAL SALES CONDITIONS	CONDITIONS GÉNÉRALES DE VENTE	ALLGEMEINE VERKAUFSBEDINGUNGEN	182



Carrelli e mobili di servizio in legno

WOOD TROLLEYS AND SERVICE FURNITURE
CHARIOTS ET MEUBLES DE SERVICE EN BOIS
WAGEN UND SERVICEMÖBEL AUS HOLZ

CA 901 2R



CA 901 2R

IT Carrelli Guéridon. Struttura portante in tubo di acciaio inox AISI 304 - ripiani in nobilitato con bordo in gomma - carrelli disponibili nei colori noce e wengé - 2 ruote multidirezionali ø 95 mm.

EN Guéridon trolleys. Tubular stainless steel AISI 304 supporting structure - melamine shelves with rubber edges - trolleys available in walnut and wenge colour - 2 multidirectional wheels ø 95 mm.

FR Chariots Guéridon. Structure portante en tube d'acier inox AISI 304 - étagères en mélaminé avec bord en caoutchouc - chariots disponibles en noyer et wengé - 2 roues multidirectionnelles ø 95 mm.

DE Guéridon Wagen. Stützrahmen aus Edelstahlrohr AISI 304 - Regale aus Melamin mit Gummikante - Wagen in den Farben Nussbaum und Wenge erhältlich - 2 Mehrweg-Räder ø 95 mm.

i	CA 901 2R noce-walnut	CA 901 2RW wengé
↗ cm	70 x 50 x 78(h) cm	
N.	2	
MAX Kg	40 Kg	
	320 €	

CA 901

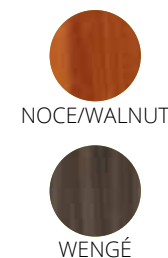

CA 901

IT Carrelli Guéridon. Struttura portante in tubo di acciaio inox AISI 304 - ripiani in nobilitato con bordo in gomma - carrelli disponibili nei colori noce e wengé - 4 ruote multidirezionali ø 95 mm.

EN Guéridon trolleys. Tubular stainless steel supporting structure AISI 304 - melamine shelves with rubber edges - trolleys available in walnut and wenge colour - 4 multidirectional wheels ø 95 mm.

FR Chariots Guéridon. Structure portante en tube d'acier inox AISI 304 - étagères en mélaminé avec bord en caoutchouc - chariots disponibles en noyer et wengé - 4 roues multidirectionnelles ø 95 mm.

DE Guéridon Wagen. Stützrahmen aus Edelstahlrohr AISI 304 - Einlegeböden aus Melamin mit Gummikante - Wagen in den Farben Walnuss und Wenge erhältlich - 4 Mehrwegräder ø 95 mm.

i	CA 901 noce-walnut	CA 901W wengé
↗ cm	70 x 50 x 78(h) cm	
N.	2	
MAX Kg	40 Kg	
	340 €	

Carrelli Guéridon
Guéridon trolleys

OPTIONAL



CL 903



CL 903B

IT Carrelli Guéridon. Struttura portante in legno massello - ripiani in nobilitato con bordo in gomma - carrelli disponibili nei colori noce, wengè, bianco o nero - ruote multidirezionali ottonate ø 95 mm.

EN Guéridon trolleys. Solid wood supporting structure - melamine shelves with rubber edges - trolleys available in walnut, wenge, white or black colour - multidirectional brass-plated wheels ø 95 mm.

FR Chariots Guéridon. Structure portante en bois massif - étagères en mélaminé avec bord en caoutchouc - chariots disponibles en noyer, wengè, blanc ou noir - roues multidirectionnelles laitonées ø 95 mm.

DE Guéridon Wagen. Stützrahmen aus Massivholz- Einlegeböden aus Melamin mit Gummikante - Wagen in den Farben Walnuss, Wenge, Schwarz und Weiß erhältlich - messingbeschichtete Mehrwegräder ø 95 mm.

i	CL 903 noce-walnut	CL 903W wengé	CL 903B bianco-white	CL 903N nero-black
↗ cm	70 x 50 x 78(h) cm			
N.	2			
MAX Kg	40 Kg			
	335 €		620 €	

CLE



CLE

IT Carrelli Guéridon. Struttura in legno massello - ripiani in multistrato di betulla - disponibile nel colore noce - ruote multidirezionali ø 95 mm. Su richiesta disponibili altri colori RAL.

EN Guéridon trolleys. Solid wood structure - multi-layered birch shelves - available in walnut colour - multidirectional brass-plated wheels ø 95 mm. Further RAL colours available on request.

FR Chariots Guéridon. Structure en bois massif - étagères en multicouche de bouleau - disponible en couleur noyer - roues multidirectionnelles de ø 95 mm. Couleurs RAL disponibles sur demande.

DE Guéridon Wagen. Massivholzrahmen - Einlegeböden aus Birkensperholz - erhältlich in Walnussfarbe - Mehrwegräder ø 95 mm. RAL-Farben auf Anfrage erhältlich.

i	CLE noce-walnut	CLE ral
↗ cm	90 x 45 x 77(h) cm	
N.	2	
MAX Kg	40 Kg	
	—	—

CLP 2002



CLP 2002N

IT Carrelli di servizio in legno. Struttura in legno massello - ripiani in multistrato di betulla - maniglie di spinta integrate nel piano superiore - ringhiere di contenimento sui piani inferiori - carrelli disponibili nei colori noce, wengé, bianco e nero - ruote multidirezionali cromate ø 95 mm.

EN Wooden service trolleys. Solid wood structure - birch multi-layered wood shelves - integrated push handles in the upper shelf - retaining rails on the lower shelves - trolleys available in walnut, wengé, white and black colour - multidirectional chrome-plated wheels ø 95 mm.

FR Chariots de service en bois. Structure en bois massif - étagères en bouleau multicouche - poignées de poussée intégrées à l'étagère supérieur - profilés de retenue aux étagères inférieurs - chariots disponibles en noyer, wengé, blanc et noir - roues multidirectionnelles chromées ø 95 mm.

DE Servicewagen aus Holz. Massivholzstruktur - Ablageflächen aus Birkensperrholz - Schubgriffe eingebaut an der obersten Fläche - Halterungen in den untersten Etagen - Wagen in Nussbaum, Wenge, Weiß und Schwarz erhältlich - Mehrweg-Chromräder ø 95 mm.

i	CLP 2002 noce-walnut	CLP 2002W wengé	CLP 2002B bianco-white	CLP 2002N nero-black
cm	110 x 55 x 82(h) cm			
N.	2			
MAX Kg	80 Kg			
	710 €		870 €	

CLP 2002 L40

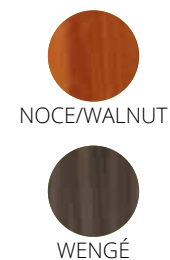

CLP 2002 L40W

IT Carrelli di servizio in legno. Struttura in legno massello - ripiani in multistrato di betulla - maniglie di spinta integrate nel piano superiore - carrelli disponibili nei colori noce e wengé - ruote multidirezionali cromate ø 95 mm.

EN Wooden service trolleys. Solid wood structure - birch multi-layered wood shelves - integrated push handles in the upper shelf - trolleys available in walnut and wengé colour - multidirectional chrome-plated wheels ø 95 mm.

FR Chariots de service en bois. Structure en bois massif - étagères en bouleau multicouche - poignées de poussée intégrées à l'étagère supérieur - p chariots disponibles en noyer et wengé - roues multidirectionnelles chromées ø 95 mm.

DE Servicewagen aus Holz. Massivholzstruktur - Ablageflächen aus Birkensperrholz - Schubgriffe eingebaut an der obersten Fläche - Wagen in Nussbaum und Wenge - Mehrweg-Chromräder ø 95 mm.

i	CLP 2002 L40 noce-walnut	CLP 2002 L40W wengé
cm	110 x 40 x 82(h) cm	
N.	2	
MAX Kg	80 Kg	
	610 €	

Carrelli di servizio in legno
Wooden service trolleys

OPTIONAL



CLP 2003



CLP 2003B

- IT** Carrelli di servizio in legno. Struttura in legno massello - ripiani in multistrato di betulla - maniglie di spinta integrate nel piano superiore - ringhiere di contenimento sui piani inferiori - carrelli disponibili nei colori noce, wengé, bianco e nero - ruote multidirezionali cromate \varnothing 95 mm.
- EN** Wooden service trolleys. Solid wood structure - birch multi-layered wood shelves - integrated push handles in the upper shelf - retaining rails on the lower shelves - trolleys available in walnut, wengé, white and black colour - multidirectional chrome-plated wheels \varnothing 95 mm.
- FR** Chariots de service en bois. Structure en bois massif - étagères en bouleau multicouche - poignées de poussée intégrées à l'étagère supérieure - profilés de retenue aux étagères inférieures - chariots disponibles en noyer, wengé, blanc et noir - roues multidirectionnelles chromées \varnothing 95 mm.
- DE** Servicewagen aus Holz. Massivholzstruktur - Ablageflächen aus Birkensperrholz - Schubgriffe eingebaut an der obersten Fläche - Halterungen in den untersten Etagen - Wagen in Nussbaum, Wenge, Weiß und Schwarz erhältlich - Mehrweg-Chromräder \varnothing 95 mm.

	CLP 2003 noce-walnut	CLP 2003W wengé	CLP 2003B bianco-white	CLP 2003N nero-black
	110 x 55 x 89(h) cm			
	3			
	80 Kg			
	940 €		1.170 €	

CLP 2003 L40

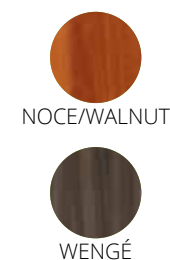

CLP 2003 L40

- IT** Carrelli di servizio in legno. Struttura in legno massello - ripiani in multistrato di betulla - maniglie di spinta integrate nel piano superiore - ringhiere di contenimento sui piani inferiori - carrelli disponibili nei colori noce e wengé - ruote multidirezionali cromate \varnothing 95 mm.
- EN** Wooden service trolleys. Solid wood structure - birch multi-layered wood shelves - integrated push handles in the upper shelf - retaining rails on the lower shelves - trolleys available in walnut and wengé colour - multidirectional chrome-plated wheels \varnothing 95 mm.
- FR** Chariots de service en bois. Structure en bois massif - étagères en bouleau multicouche - poignées de poussée intégrées à l'étagère supérieure - chariots disponibles en noyer et wengé - roues multidirectionnelles chromées \varnothing 95 mm.
- DE** Servicewagen aus Holz. Massivholzstruktur - Ablageflächen aus Birkensperrholz - Schubgriffe eingebaut an der obersten Fläche - Wagen in Nussbaum und Wenge - Mehrweg-Chromräder \varnothing 95 mm.

	CLP 2003 L40 noce-walnut	CLP 2003 L40W wengé
	110 x 40 x 89(h) cm	
	3	
	80 Kg	
	740 €	

CL 2000



CL 2000

IT Carrelli di servizio in legno. Struttura in legno multistrato di betulla - ripiani in nobilitato - cornice perimetrale e maniglia in legno massello - disponibili nei colori noce e wengé - ruote multidirezionali di serie cromate ø 95 mm.

EN Wooden service trolleys. Birch multi-layered wood structure - melamine shelves - solid wood perimeter frame and handle - available in walnut and wenge colour - standard multidirectional chrome-plated wheels ø 95 mm.

FR Chariots de service en bois. Structure en bouleau multicouche - étagères en bois mélaminé - cadre périmétral et poignée en bois massif - disponible en noyer et wengé - de série roues multidirectionnelles chromées ø 95 mm.

DE Servicewagen aus Holz. Struktur aus Birkensperrholz - Regale aus melaminharzbeschichtetem Birkenholz - Zierrahmen und Griff aus Struktur aus Birkenfurnierholz - Ablagefläche aus Furnierholz - umlaufender Rahmen und Griff aus Massivholz - erhältlich in den Farben Nussbaum und Wenge - serienmäßig mit Mehrweg-Chromräder ø 95 mm.

i	CL 2000 noce-walnut	CL 2000W wengé
cm	86 x 55 x 85(h) cm	
N.	2	
MAX Kg	80 Kg	
	750 €	

CL 2001

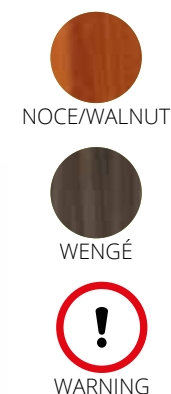

CL 2001W

IT Carrelli di servizio in legno. Struttura in legno multistrato di betulla - ripiani in nobilitato - cornice perimetrale in legno massello - disponibili nei colori noce e wengé - ruote multidirezionali cromate ø 95 mm.

EN Wooden service trolleys. Birch multi-layered wood structure - melamine shelves - solid wood perimeter frame - available in walnut and wenge colour - multidirectional chrome-plated wheels ø 95 mm.

FR Chariots de service en bois. Structure en bouleau mélaminé - étagères en bois multicouche - cadre périmétral en bois massif - disponible en noyer et wengé - roues multidirectionnelles chromées ø 95 mm.

DE Servicewagen aus Holz. Struktur aus Birkensperrholz - Regale aus melaminharzbeschichtetem Birkenholz - Zierrahmen und Griff aus Struktur aus Birkenfurnierholz - Ablagefläche aus Furnierholz - umlaufender Rahmen aus Massivholz - erhältlich in den Farben Nussbaum und Wenge - Mehrweg-Chromräder ø 95 mm.

i	CL 2001 noce-walnut	CL 2001W wengé
cm	106 x 55 x 85(h) cm	
N.	2	
MAX Kg	80 Kg	
	790 €	



Foto con OPTIONAL - n. 4 ruote con cuffia ottonata o cromata
Photos with OPTIONAL - 4 Brass or chrome ball casters
Photo avec ACCESSOIRES - 4 Roulette à bille en laiton ou chromée
Abgebildet mit ZUBEHÖR - 4 Messing- oder Chrom-Kugelrolle

OPTIONAL



CL 2150



CL 2150

IT Carrelli di servizio in legno. Struttura in legno multistrato di betulla - ripiani in nobilitato - cornice perimetrale e maniglia in legno massello - disponibili nei colori noce e wengé - ruote multidirezionali di serie cromate ø 95 mm.

EN Wooden service trolleys. Birch multi-layered wood structure - melamine shelves - solid wood perimeter frame and handle - available in walnut and wenge colour - standard multidirectional chrome-plated wheels ø 95 mm.

FR Chariots de service en bois. Structure en bouleau multicouche - étagères en bois mélaminé - cadre périmétral et poignée en bois massif - disponible en noyer et wengé - de série roues multidirectionnelles chromées ø 95 mm.

DE Servicewagen aus Holz. Struktur aus Birkenperrholz - Regale aus melaminharzbeschichtetem Birkenholz - Zierrahmen und Griff aus Struktur aus Birkenfurnierholz - Ablagefläche aus Furnierholz - umlaufender Rahmen und Griff aus Massivholz - erhältlich in den Farben Nussbaum und Wenge - serienmäßig mit Mehrweg-Chromräder ø 95 mm.

i	CL 2150 noce-walnut	CL 2150W wengé
↗ cm	86 x 55 x 85(h) cm	
N.	3	
MAX Kg	80 Kg	
	875 €	

CL 2151

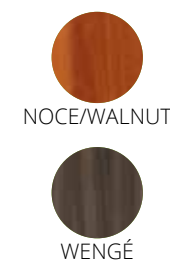

CL 2151W

IT Carrelli di servizio in legno. Struttura in legno multistrato di betulla - ripiani in nobilitato - cornice perimetrale e maniglia in legno massello - disponibili nei colori noce e wengé - ruote multidirezionali di serie cromate ø 95 mm.

EN Wooden service trolleys. Birch multi-layered wood structure - melamine shelves - solid wood perimeter frame and handle - available in walnut and wenge colour - standard multidirectional chrome-plated wheels ø 95 mm.

FR Chariots de service en bois. Structure en bouleau multicouche - étagères en bois mélaminé - cadre périmétral et poignée en bois massif - disponible en noyer et wengé - de série roues multidirectionnelles chromées ø 95 mm.

DE Servicewagen aus Holz. Struktur aus Birkenperrholz - Regale aus melaminharzbeschichtetem Birkenholz - Zierrahmen und Griff aus Struktur aus Birkenfurnierholz - Ablagefläche aus Furnierholz - umlaufender Rahmen und Griff aus Massivholz - erhältlich in den Farben Nussbaum und Wenge - serienmäßig mit Mehrweg-Chromräder ø 95 mm.

i	CL 2151 noce-walnut	CL 2151W wengé
↗ cm	106 x 55 x 85(h) cm	
N.	3	
MAX Kg	80 Kg	
	920 €	

LP 800

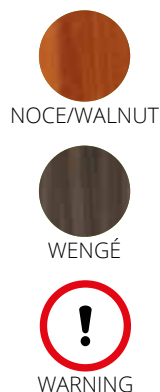

LP 800

IT Carrelli di servizio in legno. Struttura in legno massello - ripiani in nobilitato di betulla - carrelli disponibili nei colori noce o wengé - ruote multidirezionali cromate ø 100 mm.

EN Wooden service trolleys. Solid wood structure - birch multi-layered wood shelves - trolleys available in walnut or wenge colour - multidirectional chrome-plated wheels ø 100 mm.

FR Chariots de service en bois. Structure en bois massif - étagères en bouleau mélaminé - chariot disponible en noyer ou wengé - roues multidirectionnelles chromées ø 100 mm.

DE Servicewagen aus Holz. Struktur aus melaminharzbeschichtetem Birkenholz - Regale aus melaminharzbeschichtetem Birkenholz - Zierrahmen und Griff aus Struktur aus Massivholz- Ablagefläche aus Birkenfurnierholz - erhältlich in den Farben Nussbaum oder Wenge - Mehrweg-Chromräder ø 100 mm.

i	LP 800 noce-walnut	LP 800W wengé
cm	81 x 55 x 82(h) cm	
N.	2	
MAX Kg	80 Kg	
	930 €	

LP 850

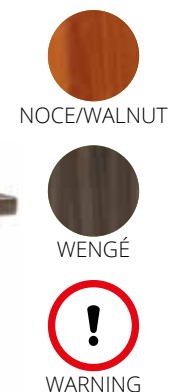

LP 850W

IT Carrelli di servizio in legno. Struttura in legno massello - ripiani in nobilitato di betulla - carrelli disponibili nei colori noce o wengé - ruote multidirezionali cromate ø 100 mm.

EN Wooden service trolleys. Solid wood structure - birch multi-layered wood shelves - trolleys available in walnut or wenge colour - multidirectional chrome-plated wheels ø 100 mm.

FR Chariots de service en bois. Structure en bois massif - étagères en bouleau mélaminé - chariot disponible en noyer ou wengé - roues multidirectionnelles chromées ø 100 mm.

DE Servicewagen aus Holz. Struktur aus melaminharzbeschichtetem Birkenholz - Regale aus melaminharzbeschichtetem Birkenholz - Zierrahmen und Griff aus Struktur aus Massivholz- Ablagefläche aus Birkenfurnierholz - erhältlich in den Farben Nussbaum oder Wenge - Mehrweg-Chromräder ø 100 mm.

i	LP 850 noce-walnut	LP 850W wengé
cm	81 x 55 x 82(h) cm	
N.	3	
MAX Kg	80 Kg	
	1.120 €	



Foto con OPTIONAL - n. 4 ruote con cuffia ottonata o cromata
Photos with OPTIONAL - 4 Brass or chrome ball casters
Photo avec ACCESSOIRES - 4 Roulette à bille en laiton ou chromée
Abgebildet mit ZUBEHÖR - 4 Messing- oder Chrom-Kugelrolle

OPTIONAL



LP 1000

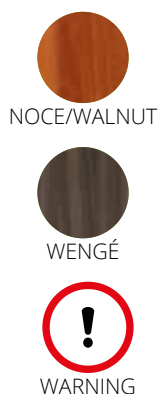

LP 1000

IT Carrelli di servizio in legno. Struttura in legno massello - ripiani in nobilitato di betulla - carrelli disponibili nei colori noce o wengé - ruote multidirezionali cromate ø 100 mm.

EN Wooden service trolleys. Solid wood structure - birch multi-layered wood shelves - trolleys available in walnut or wenge colour - multidirectional chrome-plated wheels ø 100 mm.

FR Chariots de service en bois. Structure en bois massif - étagères en bouleau mélaminé - chariot disponible en noyer ou wengé - roues multidirectionnelles chromées ø 100 mm.

DE Servicewagen aus Holz. Struktur aus melaminharzbeschichtetem Birkenholz - Regale aus melaminharzbeschichtetem Birkenholz - Zierrahmen und Griff aus Struktur aus Massivholz- Ablagefläche aus Birkenfurnierholz - erhältlich in den Farben Nussbaum oder Wenge - Mehrweg-Chromräder ø 100 mm.

i	LP 1000 noce-walnut	LP 1000W wengé
cm	115 x 55 x 82(h) cm	
N.	2	
MAX Kg	80 Kg	
	975 €	

LP 1050

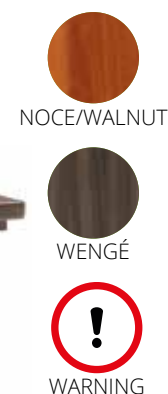

LP 1050W

IT Carrelli di servizio in legno. Struttura in legno massello - ripiani in nobilitato di betulla - carrelli disponibili nei colori noce o wengé - ruote multidirezionali cromate ø 100 mm.

EN Wooden service trolleys. Solid wood structure - birch multi-layered wood shelves - trolleys available in walnut or wenge colour - multidirectional chrome-plated wheels ø 100 mm.

FR Chariots de service en bois. Structure en bois massif - étagères en bouleau mélaminé - chariot disponible en noyer ou wengé - roues multidirectionnelles chromées ø 100 mm.

DE Servicewagen aus Holz. Struktur aus melaminharzbeschichtetem Birkenholz - Regale aus melaminharzbeschichtetem Birkenholz - Zierrahmen und Griff aus Struktur aus Massivholz- Ablagefläche aus Birkenfurnierholz - erhältlich in den Farben Nussbaum oder Wenge - Mehrweg-Chromräder ø 100 mm.

i	LP 1050 noce-walnut	LP 1050W wengé
cm	115 x 55 x 82(h) cm	
N.	3	
MAX Kg	80 Kg	
	1.160 €	

20 Carrelli di servizio in legno
Wooden service trolleys



Foto con OPTIONAL - n. 4 ruote con cuffia ottonata o cromata
Photos with OPTIONAL - 4 Brass or chrome ball casters
Photo avec ACCESSOIRES - 4 Roulette à bille en laiton ou chromée
Abgebildet mit ZUBEHÖR - 4 Messing- oder Chrom-Kugelrolle

CLC 2012



CLC 2012



IT Carrelli di servizio in legno con cupola. Struttura in legno massello - ripiani in multistrato di betulla - cupola semicircolare in plexiglass apribile su due lati - maniglie di spinta integrate nel piano superiore - ringhiere di contenimento sui piani inferiori- carrelli disponibili nei colori noce, wengè, bianco e nero - ruote multidirezionali di serie cromate ø 95 mm.

EN Wooden service trolleys with dome. Solid wood structure - birch multi-layered wood shelves - half-circle dome in Plexiglas that opens on two sides - integrated push handles in the upper shelf - retaining rails on the lower shelves - trolleys available in walnut, wengè, white and black colour - standard multidirectional chrome-plated wheels ø 95 mm.

FR Chariots de service en bois avec clochette. Structure en bois massif - étagères en bouleau multicouche - clochette en plexiglas de forme semi-circulaire avec ouverture sur les deux côtés - poignées de poussée intégrées à l'étagère supérieur - profilés de retenue aux étagères inférieures - chariots disponibles en noyer, wengè, blanc et noir - de série roues multidirectionnelles chromées ø 95 mm.

DE Servicewagen aus Holz für Kuchen. Massivholzstruktur - Ablageflächen aus Birkenperrholz - zweiseitig aufklappbare, halbrunde Plexiglashaube - Schubgriffe eingebaut an der obersten Fläche - Halterungen in den untersten Etagen - Wagen in Nussbaum, Wenge, Weiß und Schwarz erhältlich - Mehrweg-Chromräder ø 95 mm.

i	CLC 2012 noce-walnut	CLC 2012W wengé	CLC 2012B bianco-white	CLC 2012N nero-black
cm	110 x 55 x 107(h) cm			
N.	2			
MAX Kg	80 Kg			
	1.010 €		1.162 €	

CLC 2013



CLC 2013W

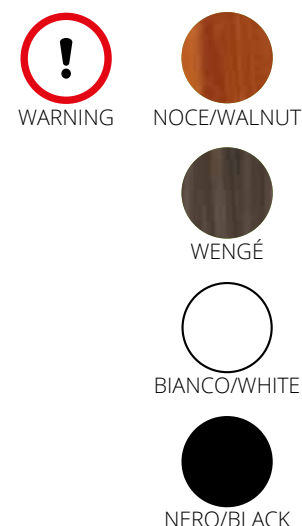

IT Carrelli di servizio in legno con cupola. Struttura in legno massello - ripiani in multistrato di betulla - cupola semicircolare in plexiglass apribile su due lati - maniglie di spinta integrate nel piano superiore - ringhiere di contenimento sui piani inferiori- carrelli disponibili nei colori noce, wengè, bianco e nero - ruote multidirezionali di serie cromate ø 95 mm.

EN Wooden service trolleys with dome. Solid wood structure - birch multi-layered wood shelves - half-circle dome in Plexiglas that opens on two sides - integrated push handles in the upper shelf - retaining rails on the lower shelves - trolleys available in walnut, wengè, white and black colour - standard multidirectional chrome-plated wheels ø 95 mm.

FR Chariots de service en bois avec clochette. Structure en bois massif - étagères en bouleau multicouche - clochette en plexiglas de forme semi-circulaire avec ouverture sur les deux côtés - poignées de poussée intégrées à l'étagère supérieur - profilés de retenue aux étagères inférieures - chariots disponibles en noyer, wengè, blanc et noir - de série roues multidirectionnelles chromées ø 95 mm.

DE Servicewagen aus Holz für Kuchen. Massivholzstruktur - Ablageflächen aus Birkenperrholz - zweiseitig aufklappbare, halbrunde Plexiglashaube - Schubgriffe eingebaut an der obersten Fläche - Halterungen in den untersten Etagen - Wagen in Nussbaum, Wenge, Weiß und Schwarz erhältlich - Mehrweg-Chromräder ø 95 mm.

i	CLC 2013 noce-walnut	CLC 2013W wengé	CLC 2013B bianco-white	CLC 2013N nero-black
cm	110 x 55 x 114(h) cm			
N.	3			
MAX Kg	80 Kg			
	1.230 €		1.460 €	

Carrelli di servizio in legno con cupola
Wooden service trolleys with dome

OPTIONAL



CL 2255 - CL 2260



h 58 cm

CL 2255W

IT Carrelli di servizio in legno con cupola. Struttura portante in legno multistrato di betulla - cupola semicircolare in plexiglass apribile su due lati - maniglia di spinta in legno - disponibile nei colori noce e wengé - 2 ripiani - ruote multidirezionali \varnothing 100 mm. Il carrello in foto è con optional pianetto reggiplatto a scomparsa e cassetto portaposate a 3 scomparti .

EN Wooden service trolleys with dome. Load-bearing structure in birch multi-layered wood - half-circle dome in Plexiglas that opens on two sides - wooden push handle - available in walnut and wenge - 2 shelves - multidirectional wheels \varnothing 100 mm. The trolley shown here is equipped with optional retractable plate support and cutlery drawer with 3 compartments.

FR Chariots de service en bois avec clochette. Structure portante en bouleau multicouche - clochette en plexiglas de forme semi-circulaire avec ouverture sur les deux côtés - poignée en bois - disponible en noyer et wengé - 2 étagères- roues multidirectionnelles \varnothing 100 mm. Le chariot illustré est équipé en option d'un support pour assiettes rétractable et d'un tiroir à couverts à 3 compartiments.

DE Servicewagen aus Holz für Kuchen. Struktur aus Birkensperholz Birkenholz - zweiseitig aufklappbare, halbrunde Plexiglashaube - Schubgriff aus Holz - erhältlich in Nussbaum und Wenge - 2 Einlegeböden - Mehrwegräder \varnothing 100 mm. Der Wagen auf dem Bild ist mit dem ausziehbarem Pfannenträger und Besteckschublade mit 3 Fächern ausgestattet.

i	CL 2255 noce-walnut	CL 2255W wengé	CL 2260 noce-walnut	CL 2260W wengé
cm	86 x 55 x 110(h) cm		106 x 55 x 110(h) cm	
N.	2			
MAX Kg	80 Kg			
	1.000 €		1.055 €	

CL 2350 - CL 2351

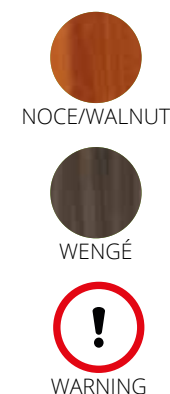

h 58 cm

CL 2350

IT Carrelli di servizio in legno con cupola. Struttura e ripiani in legno nobilitato - cupola semicircolare in plexiglass - maniglia di spinta in legno - disponibile nei colori noce e wengé - ruote multidirezionali 100 mm. Il carrello in foto è con optional pianetto reggiplatto a scomparsa e cassetto portaposate a 3 scomparti.

EN Wooden service trolleys with dome. Load-bearing structure in birch multi-layered wood - half-circle dome in Plexiglas - wooden push handle - available in walnut and wenge - multidirectional wheels \varnothing 100 mm. The trolley shown here is equipped with retractable plate support and cutlery drawer with 3 compartments.

FR Chariots de service en bois avec clochette. Structure portante en bouleau multicouche - clochette en plexiglas de forme semi-circulaire - poignée en bois - disponible en noyer et wengé - roues multidirectionnelles \varnothing 100 mm. Le chariot illustré est équipé en option d'un support pour assiettes rétractable et d'un tiroir à couverts à 3 compartiments.

DE Servicewagen aus Holz für Kuchen. Struktur aus Birkensperholz und Ablageflächen aus melaminharzbeschichtetem Birkenholz - halbrunde Plexiglashaube - Schubgriff aus Holz - erhältlich in Nussbaum und Wenge - Mehrwegräder \varnothing 100 mm. Der Wagen auf dem Bild ist mit dem ausziehbarem Pfannenträger und Besteckschublade mit 3 Fächern ausgestattet.

i	CL 2350 noce-walnut	CL 2350W wengé	CL 2351 noce-walnut	CL 2351W wengé
cm	86 x 55 x 95(h) cm		106 x 55 x 95(h) cm	
N.	2			
MAX Kg	80 Kg			
	990 €		1.050 €	

LPC 800 LPC 850



LPC 800



NOCE/WALNUT



WENGÉ



WARNING

LPC 1000 LPC 1050



LPC 1050



NOCE/WALNUT



WENGÉ



WARNING

IT Carrelli di servizio in legno con cupola. Struttura portante in legno massello - ripiani in nobilitato di betulla - cupola semicircolare in plexiglass - ripiani in nobilitato - cornice perimetrale in legno massello - disponibile in colori noce o wengé - modelli a 2 o 3 ripiani - ruote multidirezionali ø 100 mm.

EN Wooden service trolleys with dome. Load-bearing structure in solid wood - shelves in birch laminated wood - half-circle dome in Plexiglas - melamine shelves - solid wood perimeter frame - available in walnut or wengé colour - models with 2 or 3 shelves - multidirectional wheels ø 100 mm.

FR Chariots de service en bois avec clochette. Structure portante en bois massif - étagères en bouleau mélaminé - clochette en plexiglas de forme semi-circulaire - étagères en bouleau stratifié - cadre périmétral en bois massif - disponible en noyer ou wengé - modèles à 2 ou 3 étagères - roues multidirectionnelles ø 100 mm.

DE Servicewagen aus Holz für Kuchen. Struktur aus Massivholz - Ablageflächen aus melaminharzbeschichtetem Birkenholz - halbrunde Plexiglashaube - Ablageflächen aus Melamin - umlaufender Rahmen aus Massivholz - erhältlich in den Farben Nussbaum oder Wenge - Modelle mit 2 oder 3 Einlegeböden - Mehrwegräder ø 100 mm.

IT Carrelli di servizio in legno con cupola. Struttura portante in legno massello - ripiani in nobilitato di betulla - cupola semicircolare in plexiglass - ripiani in nobilitato - cornice perimetrale in legno massello - disponibile in colori noce o wengé - modelli a 2 o 3 ripiani - ruote multidirezionali ø 100 mm.

EN Wooden service trolleys with dome. Load-bearing structure in solid wood - shelves in birch laminated wood - half-circle dome in Plexiglas - melamine shelves - solid wood perimeter frame - available in walnut or wengé colour - models with 2 or 3 shelves - multidirectional wheels ø 100 mm.

FR Chariots de service en bois avec clochette. Structure portante en bois massif - étagères en bouleau mélaminé - clochette en plexiglas de forme semi-circulaire - étagères en bouleau stratifié - cadre périmétral en bois massif - disponible en noyer ou wengé - modèles à 2 ou 3 étagères - roues multidirectionnelles ø 100 mm.

DE Servicewagen aus Holz für Kuchen. Struktur aus Massivholz - Ablageflächen aus melaminharzbeschichtetem Birkenholz - halbrunde Plexiglashaube - Ablageflächen aus Melamin - umlaufender Rahmen aus Massivholz - erhältlich in den Farben Nussbaum oder Wenge - Modelle mit 2 oder 3 Einlegeböden - Mehrwegräder ø 100 mm.

i	LPC 800 noce-walnut	LPC 800W wengé	LPC 850 noce-walnut	LPC 850W wengé
cm	81 x 55 x 108(h) cm			
N.	2		3	
MAX Kg	80 Kg			
	1.170 €		1.370 €	

i	LPC 1000 noce-walnut	LPC 1000W wengé	LPC 1050 noce-walnut	LPC 1050W wengé
cm	115 x 55 x 108(h) cm			
N.	2		3	
MAX Kg	80 Kg			
	1.275 €		1.410 €	



Foto con OPTIONAL - n. 4 ruote con cuffia ottonata o cromata
Photos with OPTIONAL - 4 Brass or chrome ball casters
Photo avec ACCESSOIRES - 4 Roulette à bille en laiton ou chromée
Abgebildet mit ZUBEHÖR - 4 Messing- oder Chrom-Kugelrolle

OPTIONAL



CL 2785

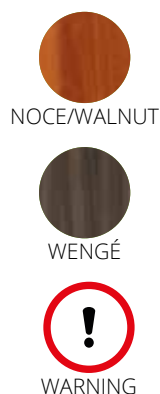

CL 2785

IT Carrello di servizio in legno con cupola. Struttura portante in legno multistrato di betulla - cupola in plexiglass trasparente 150(h) mm - vasca e griglia in acciaio inox - 8 piastre eutettiche refrigeranti - ruote multidirezionali ø 100 mm. Può contenere numero 5 bacinelle GN1/4 con 65(h) mm oppure 5 bacinelle GN1/6 con 65(h) mm.

EN Wooden service trolley with dome. Multi-layered birch wood supporting structure - clear Plexiglas dome 150(h) mm - stainless steel bowl and grid - 8 refrigerant eutectic plates - multidirectional wheels ø 100 mm. It can contain 5 GN1/4 containers 65(h) mm or 5 GN1/6 containers 65(h) mm.

FR Chariot de service en bois avec clochette. Structure portante en bouleau multicouche - clochette en plexiglas transparent 150(h) mm - cuve et grille en acier inox - 8 plaques de refroidissement eutectiques - roues multidirectionnelles ø 100 mm. Contient 5 bacs GN1/4 avec 65(h) mm ou 5 bacs GN1/6 avec 65(h) mm.

DE Servicewagen aus Holz für Kuchen. Tragkonstruktion aus Birkensperrholz - transparente Plexiglashaube 150(h) mm - Edelstahlbehälter und Grill - 8 Eutektik-Kühlplatten - Mehrwegräder ø 100 mm. Enthält 5 GN1/4 Behälter mit 65(h) mm oder 5 GN1/6 Behälter mit 65(h) mm.

	CL 2785 noce-walnut	CL 2785W wengé
	106 x 55 x 108(h) cm	
	2	
	1.960 €	

Carrelli di servizio in legno con cupola

WOODEN SERVICE TROLLEYS WITH DOME
CHARIOTS DE SERVICE EN BOIS AVEC CLOCHETTE
SERVICEWAGEN AUS HOLZ MIT HAUBE

A 100
Pianetto reggipiatto a scomparsa Retractable shelf Étagère à plateaux encastrée Verdeckte Tablettablage
77 €
A 200
Cassetto portaposate a 3 scomparti Cutlery drawer with 3 compartments Tiroir à couverts avec 3 compartiments Besteckschublade mit 3 Fächern
110 €

CL 2751 - CL 2752



CL 2751

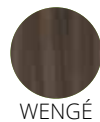

↑ h 91 cm ↓

IT Carrelli Flambè. Struttura portante in legno multistrato di betulla monocorpo - rivestimento in legno massello di castagno - piano di cottura in acciaio inox - ribaltina laterale - maniglia di spinta in acciaio cromato - portabottiglie in acciaio cromato - 2 cassetti - vano porta bombola da 2 kg - ruote multidirezionali ø 100 mm.

EN Flambé trolleys. Load-bearing structure in one-piece multi-layered wood - solid chestnut wood lining - stainless steel cooking plate - side folding panel - chrome-plated steel push handle - chrome-plated steel bottle rack - 2 drawers - 2 kg gas bottle compartment - multidirectional wheels ø 100 mm.

FR Chariots Flambé. Structure portante en bois de bouleau multicouche à structure monocoque - revêtement en châtaignier massif - plaque de cuisson en acier inox - volet latéral - poignée de poussée en acier chromé - porte-bouteille en acier chromé - 2 tiroirs - compartiment porte-bouteille de 2 kg - roues multidirectionnelles ø 100 mm.

DE Flambè-Wagen. Monoblock Struktur aus Birkensperholz - Verkleidung aus massivem Kastanienholz - Kochplatte aus Edelstahl - Seitenklappe - Schubgriff aus verchromtem Stahl - Flaschenständer aus verchromtem Stahl - 2 Schubladen - 2 kg Gasflaschenfach - Mehrwegräder ø 100 mm.

CL 2750



CL 2750W

↑ h 91 cm ↓

	CL 2751 noce-walnut	CL 2751W wengé	CL 2752 noce-walnut	CL 2752W wengé
				
	107/145 x 58 x 91(h) cm			
	1 piastra - 1 fuoco 1 plate - 1 burner		2 piastre a 1 fuoco separato 2 plates 1 separate burner	
	35 Kg		35 Kg	
	1.710 €		2.020 €	

	CL 2750 noce-walnut	CL 2750W wengé
		
	107/145 x 58 x 91(h) cm	
	1 piastra - 2 fuochi 1 plate - 2 burners	
	35 Kg	
	1.840 €	

Carrelli Flambè
Flambè trolleys



Foto con OPTIONAL - n. 4 ruote con cuffia ottonata o cromata
Photos with OPTIONAL - 4 Brass or chrome ball casters
Photo avec ACCESSOIRES - 4 Roulette à bille en laiton ou chromée
Abgebildet mit ZUBEHÖR - 4 Messing- oder Chrom-Kugelrolle

CF 1200 - CF 1201 CF 1202

NOCE/WALNUT

WENGÉ



h 91 cm

CF 1200

IT Carrelli Flambè. Struttura portante in legno nobilitato - piano di cottura in acciaio inox con bruciatore regolabile - ribaltina laterale - maniglia di spinta in acciaio cromato - portabottiglie in acciaio cromato - 1 cassetto - 1 sportello vano porta bombola da 3 Kg - ruote multidirezionali ø 100 mm.

EN Flambé trolleys. Load-bearing structure in laminated wood - stainless steel cooking plate with adjustable burner - side folding panel - chrome-plated steel push handle - chrome-plated steel bottle rack - 1 drawer - 3 kg gas bottle compartment - multidirectional wheels ø 100 mm.

FR Chariots Flambé. Structure portante en bois mélaminé - plaque de cuisson en acier inox avec brûleur réglable - volet latéral - poignée de poussée en acier chromé - porte-bouteille en acier chromé - 1 tiroir - compartiment avec porte pour bouteille de 3 kg - roues multidirectionnelles ø 100 mm.

DE Flambè-Wagen. Struktur aus melaminharzbeschichtetem Holz - Kochplatte aus Edelstahl mit einstellbarem Brenner - Schubgriff aus verchromtem Stahl - Flaschenständeraus verchromtem Stahl - 1 Schublade - 3 Kg Gasflaschenfach - Mehrwegräder ø 100 mm.

Carrelli Flambé Flambè Trolleys

AB2 CL2750-51-52	AB3 CF1200-1201-1202
Bombola gas 2 Kg. (vuota) Gas bottle 2 kg (empty) Bouteille de gaz 2 kg (vide) Gasflasche 2 kg (leer)	Bombola gas 3 Kg. (vuota) Gas bottle 3 kg (empty) Bouteille de gaz 3 kg (vide) Gasflasche 3 kg (leer)



80 €



85 €

i	CF 1200 noce-walnut	CF 1200W wengé	CF 1201 noce-walnut	CF 1201W wengé
cm	105/137 x 57 x 91(h) cm			
	1 piastra - 1 fuoco 1 plate - 1 burner		1 piastra - 2 fuochi 1 plate - 2 burners	
MAX Kg	35 Kg			
	1.245 €		1.375 €	

i	CF 1202 noce-walnut	CF 1202W wengé
cm	105/137 x 57 x 91(h) cm	
	2 piastre a 1 fuoco separato 2 plates 1 separate burner	
MAX Kg	35 Kg	
	1.570 €	



Foto con OPTIONAL - n. 4 ruote con cuffia ottonata o cromata
Photos with OPTIONAL - 4 Brass or chrome ball casters
Photo avec ACCESSOIRES - 4 Roulette à bille en laiton ou chromée
Abgebildet mit ZUBEHÖR - 4 Messing- oder Chrom-Kugelrolle

ML 3000 SS

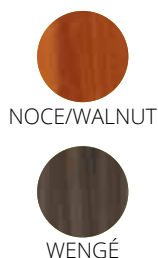

ML 3170SS ML 3170ST



ML 3000 SS

IT Mobili di servizio bassi doppi - struttura e pannelli in nobilitato con bordi protetti da profilo in gomma - 2 cassetti portaposate di cui 1 con separatore - 2 sportelli - disponibile in colore noce e wengé - ruote multidirezionali ø 50 mm.

EN Low double service cabinets - structure and panels in melamine with edges protected by rubber profile - 2 cutlery drawers, 1 with separator - 2 doors - available in walnut and wenge colour - multidirectional wheels ø 50 mm.

FR Meubles bas de service double - structure et panneaux en mélaminé avec bords en caoutchouc - 2 tiroirs à couverts dont 1 avec séparateur - 2 portes - disponible en noyer et wengé - roues multidirectionnelles ø 50 mm.

DE Niedrige Doppelservicemöbel - Struktur und Blenden aus Melamin mit Gummikantenschutz - 2 Besteckschubladen, davon 1 mit Trennwand - 2 Türen - erhältlich in Nussbaum und Wenge - Mehrwegräder ø 50 mm.

ML 3170 SS

IT Mobili di servizio alti doppi - struttura e pannelli in nobilitato con bordi protetti da profilo in gomma - sportello superiore in plexiglass fumè - 2 cassetti portaposate di cui 1 con separatore - 2 sportelli (SS) oppure 1 sportello e 1 tramoggia (ST) - disponibile in colore noce - ruote multidirezionali ø 50 mm.

EN High double service cabinets - structure and panels in melamine with edges protected by a rubber profile - smoky grey Plexiglas upper door - 2 cutlery drawers, 1 with separator - 2 doors (SS) or 1 door and 1 hopper (ST) - available in walnut colour - multidirectional wheels ø 50 mm.

FR Meubles hauts de service double - structure et panneaux en mélaminé avec bords en caoutchouc - porte supérieure en plexiglas fumé - 2 tiroirs à couverts dont 1 avec séparateur - 2 portes (SS) ou 1 porte et 1 trémie (ST) - disponible en noyer - roues multidirectionnelles ø 50 mm.

DE Hohe Doppelservicemöbel - Struktur und Blenden aus Melamin mit Gummikantenschutz - obere Tür aus dunklem Plexiglas - 2 Besteckschubladen, davon 1 mit Trennwand - 2 Türen (SS) oder 1 Tür und 1 Trichter (ST) - erhältlich in Nussbaum - Mehrwegräder ø 50 mm.

	ML 3000 SS noce-walnut	ML 3000 SSW wengé
	95 x 49 x 99(h) cm	
	2 sportelli - 2 cassetti 2 doors - 2 drawers	
	830 €	

	ML 3170 SS noce-walnut	ML 3170 ST noce-walnut
	95 x 49 x 144(h) cm	
	2 sportelli in plexiglas fumè 2 sportelli - 2 cassetti 2 doors in smoky grey Plexiglas 2 doors - 2 drawers	2 sportelli in plexiglas fumè 1 sportello - 1 tramoggia - 2 cassetti 2 doors in smoky grey Plexiglas 1 door - 1 hopper - 2 drawers
	1.310 €	1.425 €

Mobili di servizio in legno
Wooden serving furniture

OPTIONAL



ML 3150ST ML 3100SS

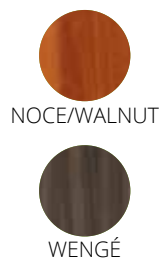

ML 3150 STW

ML 3050S



IT Mobili di servizio alti doppi - struttura e pannelli in nobilitato con bordi protetti da profilo in gomma - alzatina con 2 mensole - 2 cassetti portaposate di cui 1 con separatore - 2 sportelli (SS) oppure 1 sportello e 1 tramoggia (ST) - disponibile in colore noce e wengé - ruote multidirezionali ø 50 mm.

EN High double service cabinets - structure and panels in melamine with edges protected by rubber profile - backsplash with 2 shelves - 2 cutlery drawers, 1 with separator - 2 doors (SS) or 1 door and 1 hopper (ST) - available in walnut and wenge colour - multidirectional wheels ø 50 mm.

FR Meubles hauts de service double - structure et panneaux en mélaminé avec bords en caoutchouc - dossier avec 2 étagères - 2 tiroirs à couverts dont 1 avec séparateur - 2 portes (SS) ou 1 porte et 1 trémie (ST) - disponible en noyer et wengé - roues multidirectionnelles ø 50 mm.

DE Hohe Doppelservicemöbel - Struktur und Blenden aus Melamin mit Gummikantenschutz - Rückwand mit 2 Regalen - 2 Besteckschubladen, davon 1 mit Trennwand - 2 Türen (SS) oder 1 Tür und 1 Trichter (ST) - erhältlich in Nussbaum und Wenge - Mehrwegräder ø 50 mm.

IT Mobile di servizio alto singolo - struttura e pannelli in nobilitato con bordi protetti da profilo in gomma - alzatina con 2 mensole - 1 cassetto portaposate con separatore - 1 sportello - disponibile in colore noce - ruote multidirezionali ø 50 mm.

EN Low single service cabinet - structure and panels in melamine with edges protected by rubber profile - backsplash with 2 shelves - 1 cutlery drawer with separator - 1 door - available in walnut colour - multidirectional wheels ø 50 mm.

FR Meuble bas de service simple - structure et panneaux en mélaminé avec bords en caoutchouc - dossier avec 2 étagères - 1 tiroir à couverts avec séparateur - 1 porte - disponible en noyer et wengé - roues multidirectionnelles ø 50 mm.

DE Niedrige Doppelservicemöbel - Struktur und Blenden aus Melamin mit Gummikantenschutz - Rückwand mit 2 Regalen - 1 Besteckschublade mit Trennwand - 1 Tür - erhältlich in Nussbaumfarbe - Mehrwegräder ø 50 mm.

	ML 3150 ST noce-walnut	ML 3150 STW wengé	ML 3100 SS noce-walnut	ML 3100 SSW wengé
	95 x 49 x 144(h) cm			
	1 sportello - 1 tramoggia - 2 cassetti 1 door - 1 hopper - 2 drawers		2 sportelli - 2 cassetti 2 doors - 2 drawers	
	1.150 €		1.030 €	

	ML 3050 S noce-walnut
	45 x 49 x 144(h) cm
	1 sportello - 1 cassetto 1 door - 1 drawer
	910 €

ML 3202SS



ML 3202 SS

IT Mobili di servizio in legno. Mobili di servizio bassi doppi - struttura e pannelli in nobilitato - 2 cassetti portaposate di cui 1 con separatore - 2 sportelli - disponibile in colore noce, wengé e rovere - ruote multidirezionali ø 50 mm.

EN Wooden service cabinets. Low double service cabinets - melamine structure and panels - 2 cutlery drawers, 1 with separator - 2 doors - available in walnut, wenge and oak colour - multidirectional wheels ø 50 mm.

FR Meubles de service en bois. Meubles bas de service double - structure et panneaux en mélaminé - 2 tiroirs à couverts dont 1 avec séparateur - 2 portes - disponible en noyer, wengé et chêne - roues multidirectionnelles ø 50 mm.

DE Servicemöbel aus Holz. Niedrige Doppelservicemöbel - Struktur und Blenden aus Melamin - 2 Besteckschubladen, davon 1 mit Trennwand - 2 Türen - erhältlich in Nussbaum, Wenge und Eichenfarbe - Mehrwegräder ø 50 mm.

	ML 3202 SSN noce-walnut	ML 3202 SSW wengé	ML 3202 SS rovere-durmast
	90 x 48 x 95(h) cm		
	2 sportelli - 2 cassetti 2 doors - 2 drawers		
	870 €		

ML 3212SS



ML 3212 SS

ML 3212 SSW

IT Mobili di servizio alti doppi - struttura e pannelli in nobilitato - 2 cassetti portaposate di cui 1 con separatore - 2 sportelli - disponibile in colore noce, wengé e rovere - ruote multidirezionali ø 50 mm.

EN High double service cabinets - melamine structure and panels - 2 cutlery drawers, 1 with separator - 2 doors - available in walnut, wenge and oak colour - multidirectional wheels ø 50 mm.

FR Meubles hautes de service double - structure et panneaux en mélaminé - 2 tiroirs à couverts dont 1 avec séparateur - 2 portes - disponible en noyer, wengé et chêne - roues multidirectionnelles ø 50 mm.

DE Hohe Doppelservicemöbel - Struktur und Blenden aus Melamin - 2 Besteckschubladen, davon 1 mit Trennwand - 2 Türen - erhältlich in Nussbaum, Wenge und Eichenfarbe - Mehrwegräder ø 50 mm.

	ML 3212 SSN noce-walnut	ML 3212 SSW wengé	ML 3212 SS rovere-durmast
	90 x 48 x 155(h) cm		
	2 sportelli - 2 cassetti 2 doors - 2 drawers		
	1.230 €		

Mobili di servizio in legno
Wooden serving furniture

OPTIONAL



ML 3200S



ML 3200 SW

ML 3210S



ML 3210 SW

IT Mobili di servizio singoli bassi - struttura e pannelli in nobilitato - 1 cassetto portaposate con separatore - 1 sportello - disponibile in colore noce, wengé e rovere - ruote multidirezionali ø 50 mm.

EN High single service cabinet - melamine structure and panels - 1 cutlery drawer with separator - 1 door - available in walnut, wenge and oak colour - multidirectional wheels ø 50 mm.

FR Meubles bas de service simple - structure et panneaux en mélaminé - 1 tiroir à couverts avec séparateur - 1 porte - disponible en noyer, wengé et chêne - roues multidirectionnelles ø 50 mm.

DE Niedrige Einzelne Servicemöbeln - Struktur und Blenden aus Melamin - 1 Besteckschublade mit Trennwand - 1 Tür - erhältlich in Nussbaum, Wenge und Eichenfarbe - Mehrwegräder ø 50 mm.

IT Mobili di servizio singoli alti - struttura e pannelli in nobilitato - 1 cassetto portaposate con separatore - 1 sportello - disponibile in colore noce, wengé e rovere - ruote multidirezionali ø 50 mm.

EN High single service cabinet - melamine structure and panels - 1 cutlery drawer with separator - 1 door - available in walnut, wenge and oak colour - multidirectional wheels ø 50 mm.

FR Meubles hautes de service simple - structure et panneaux en mélaminé - 1 tiroir à couverts avec séparateur - 1 porte - disponible en noyer, wengé et chêne - roues multidirectionnelles ø 50 mm.

DE Hohe Einzelne Servicemöbeln - Struktur und Blenden aus Melamin - 1 Besteckschublade 1 mit Trennwand - 1 Tür - erhältlich in Nussbaum, Wenge und Eichenfarbe - Mehrwegräder ø 50 mm.

	ML 3200 SN noce-walnut	ML 3200 SW wengé	ML 3200 S rovere-durmast
	45 x 48 x 95(h) cm		
	1 sportello - 1 cassetto 1 door - 1 drawer		
	640 €		

	ML 3210 SN noce-walnut	ML 3210 SW wengé	ML 3210 S rovere-durmast
	45 x 48 x 155(h) cm		
	1 sportello - 1 cassetto 1 door - 1 drawer		
	995 €		

ML 3204SS



ML 3204 SS

IT Mobili di servizio bassi tripli - struttura e pannelli in nobilitato - 3 cassetti portaposate di cui 2 con separatore - 2 sportelli - 1 vano interno - disponibile in colore noce, wengé e rovere - ruote multidirezionali ø 50 mm.

EN Low triple service cabinets - melamine structure and panels - 3 cutlery drawers, 2 with separator - 2 doors - 1 internal compartment - available in walnut, wenge and oak colour - multidirectional wheels ø 50 mm.

FR Meubles bas de service triple - structure et panneaux mélaminés - 3 tiroirs à couverts, dont 2 avec séparateur - 2 portes - 1 compartiment intérieur - disponible en couleur noyer, wengé et chêne - roues multidirectionnelles ø 50 mm.

DE Niedrige Trippelservicemöbel - Struktur und Blenden aus Melamin - 3 Besteckschubladen, davon 2 mit Trennwand - 2 Türen - 1 Innenfach - erhältlich in Nussbaum, Wenge und Eichenfarbe - Mehrwegräder ø 50 mm.

	ML 3204 SSN noce-walnut	ML 3204 SSW wengé	ML 3204 SS rovere-durmast
	136 x 48 x 95(h) cm		
	2 sportelli - 3 cassetti - 1 vano interno 2 doors - 3 drawers - 1 internal compartment		
	1.130 €		

ML 3214SS



ML 3214 SSW

IT Mobili di servizio alti tripli - struttura e pannelli in nobilitato - 3 cassetti portaposate di cui 2 con separatore - 2 sportelli - 1 vano interno - disponibile in colore noce, wengé e rovere - ruote multidirezionali ø 50 mm.

EN High triple service cabinets - melamine structure and panels - 3 cutlery drawers, 3 with separator - 2 doors - 1 internal compartment - available in walnut, wenge and oak colour - multidirectional wheels ø 50 mm.

FR Meubles de service hautes triple - structure et panneaux en mélaminé - 3 tiroirs à couverts dont 2 avec séparateur - 2 portes - 1 compartiment intérieur - disponible en noyer, wengé et chêne - roues multidirectionnelles ø 50 mm.

DE Hohe Trippelservicemöbel - Struktur und Blenden aus Melamin - 3 Besteckschubladen, davon 2 mit Trennwand - 2 Türen - 1 Innenfach - erhältlich in Nussbaum, Wenge und Eichenfarbe - Mehrwegräder ø 50 mm.

	ML 3214 SSN noce-walnut	ML 3214 SSW wengé	ML 3214 SS rovere-durmast
	136 x 48 x 155(h) cm		
	2 sportelli - 3 cassetti - 1 vano interno 2 doors - 3 drawers - 1 internal compartment		
	1.530 €		

Mobili di servizio in legno
Wooden serving furniture

OPTIONAL



ML 3212 SSP

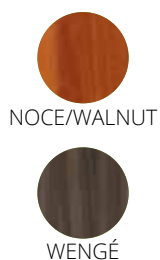

ML 3212 SSPW

IT Mobili di servizio alti doppi - struttura e pannelli in nobilitato - struttura reggi pensili in acciaio plastificato - 2 pensili - 2 cassetti portaposate di cui 1 con separatore - 2 sportelli - disponibile in colore noce e wengé - ruote multidirezionali \varnothing 50 mm. Optional tramoggia A270-A270W.

EN High double service cabinets - melamine structure and panels - plastic-coated steel wall cabinets support structure - 2 wall cabinets - 2 cutlery drawers, 1 with separator - 2 doors - available in walnut and wenge colour - multidirectional wheels \varnothing 50 mm. Optional hopper A270-A270W.

FR Meubles hautes de service double - structure et panneaux en mélaminé - 2 tiroirs à couverts dont 1 avec séparateur - 2 portes - disponible en noyer, wengé et chêne - roues multidirectionnelles \varnothing 50 mm. Trémie A270-A270W en option.

DE Hohe Servicemöbel - Struktur und Blenden aus Melamin - kunststoffbeschichtete Stahl-Halterungen - 2 Hängeschränke - 2 Besteckschubladen, davon 1 mit Trennwand - 2 Türen - erhältlich in Nussbaum und Wenge - Mehrwegräder \varnothing 50 mm. Auf Wunsch Trichter A270-A270W.

i	ML 3212 SSPN noce-walnut	ML 3212 SSPW wengé
↗ cm	92 x 48 x 153(h) cm	
	2 pensili - 2 sportelli - 2 cassetti 2 wall cabinets - 2 doors - 2 drawers	
	1.535 €	

ML 3214 SSP



ML 3214 SSPN

IT Mobili di servizio alti tripli - struttura e pannelli in nobilitato - struttura reggi pensili in acciaio plastificato - 3 pensili - 3 cassetti portaposate di cui 2 con separatore - 2 sportelli - 1 vano interno - disponibile in colore noce e wengé - ruote multidirezionali \varnothing 50 mm.

EN High triple service cabinets - melamine structure and panels - plastic-coated steel wall cabinets support structure - 3 wall cabinets - 3 cutlery drawers, 2 with separator - 2 doors - 1 internal compartment - available in walnut and wenge colour - multidirectional wheels \varnothing 50 mm.

FR Meubles de service hautes triple - structure et panneaux en mélaminé - structure de supports pour meubles à mur en acier plastifié - 3 tiroirs à couverts dont 2 avec séparateur - 2 portes - 1 compartiment intérieur - disponible en noyer et wengé - roues multidirectionnelles \varnothing 50 mm.

DE Hohe Trippelservicemöbel - Struktur und Blenden aus Melamin - kunststoffbeschichtete Stahl-Halterungen - 3 Hängeschränke - 3 Besteckschubladen, davon 2 mit Trennwand - 2 Türen - 1 Innenfach - erhältlich in Nussbaum und Wenge - Mehrwegräder \varnothing 50 mm.

i	ML 3214 SSPN noce-walnut	ML 3214 SSPW wengé
↗ cm	137 x 48 x 153(h) cm	
	3 pensili - 2 sportelli - 3 cassetti - 1 vano interno 3 wall cabinets - 2 doors - 3 drawers - 1 internal compartment	
	1.880 €	



Su tutti i modelli
On all models

CL - CLP - CLC

n. 4 ruote con cuffia ottonata o cromata
4 brass or chrome plated copper castors
4roulette à bille en laiton ou chromée
4 Messing- oder Chrom-Kugelrolle



160 €

Solo per mobili
di servizio
Service furniture only

Applicazione tramoggia per mobili
overprice for furniture hopper
surprix de trémie pour meubles
Preiszuschlag für Möbeltrichter

A 250	A 250W	A 260	A 270
ML 3000 SS		ML 3200SS	
ML 3170 SS	ML 3000SSW	ML 3202SS	
ML 3100 SS	ML 3100SSW	ML 3210S	ML 3214SSPN
ML 3050 S		ML 3212SS	ML 3214SSPW
		ML 3204SS	
		ML 3210SN	
		ML 3212SSPN	

148 €

Carrelli di servizio in legno
Wooden service trolleys

Espositore di vini - portabottiglie - struttura in legno
Wine display rack - bottle rack - wooden frame
Présentoir à vin - porte-bouteilles - structure en bois
Weinständer - Flaschenregal - Holzstruktur

	A 1250 noce-walnut	A 1250W wengé	A 1260 noce-walnut	A 1260W wengé
Mod.	CL 2000 CL 2150	CL 2000W CL 2150W	CL 2001 CL 2151	CL 2001W CL 2151W
↗ cm	68 x 46 x 19(h) cm		88 x 46 x 19(h) cm	
	290 €		370 €	



Espositore di liquori - portabottiglie - struttura in legno - ringhiere in acciaio inox
Wine display rack, bottle rack, wooden frame, stainless steel railings
Présentoir à vin, porte-bouteilles, structure en bois, barres de protection en acier inox
Weinständer - Flaschenregal - Holzstruktur, Edelstahlleisten

	A 1270 noce-walnut	A 1270W wengé	A 1280 noce-walnut	A 1280W wengé
Mod.	CL 2000 CL 2150	CL 2000W CL 2150W	CL 2001 CL 2151	CL 2001W CL 2151W
↗ cm	68 x 46 x 37(h) cm		88 x 46 x 37(h) cm	
	200 €		220 €	



Carrelli di servizio in legno Wooden service trolleys

Espositore ghiacciaia. Struttura in legno con vasca e griglia in acciaio inox - cupola plexiglass - provvisto di 8 contenitori eutettici.

Icebox display. Wooden structure with stainless steel bowl and grill - Plexiglas dome - equipped with 8 eutectic containers.

Présentoir glacière. Structure en bois avec cuve et grille en acier inox - clochette en plexiglas - équipé de 8 conteneurs eutectiques.

Gefrierfachvitrine. Holzstruktur mit Edelstahlwanne und Gitter - Plexiglashaube - ausgestattet mit 8 eutektischen Behältern.



	A 1290 noce-walnut	A 1290W wengé
Mod.	CL2001 CL2151	CL2001W CL2151W
 cm	90 x 48,5 x 23(h) cm	
	950 €	

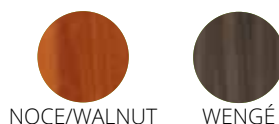

Vetrinetta con struttura in legno e cupola in plexiglass

Display with wooden structure and Plexiglas dome.

Présentoir avec structure en bois et clochette en plexiglas.

Vitrine mit Holzstruktur und Plexiglashaube.



	A 1299 noce-walnut	A 1299W wengé	A 1298 noce-walnut	A 1298W wengé
Mod.	CL 2000 CL 2150	CL 2000W CL 2150W	CL2001 CL2151	CL2001W CL2151W
 cm	70 x 50 x 22(h) cm		90 x 50 x 22(h) cm	
	395 €		425 €	



Carrelli di servizio in acciaio inox

STAINLESS STEEL SERVICE TROLLEYS
CHARIOTS DE SERVICE EN ACIER INOX
SERVICEWAGEN AUS EDELSTAHL

CA 1000 - CA 1001



CA 1000W

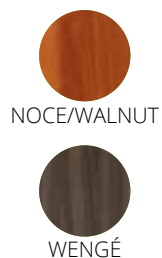

CA 1050 - CA 1051



CA 1050



IT Struttura tubolare 20x20 mm in acciaio inox **AISI 304** - ripiani in nobilitato con cornice perimetrale in acciaio inox **AISI 304** - paracolpi in gomma - ruote multidirezionali \varnothing 125 mm.

EN Tubular structure 20x20 mm in stainless steel **AISI 304** - melamine shelves with perimeter frame in stainless steel **AISI 304** - rubber shock absorber - multidirectional wheels \varnothing 125 mm.

FR Structure tubulaire 20x20 mm en acier inox **AISI 304** - étagères en mélaminé avec cadre périmétral en acier inox **AISI 304** - butoirs en caoutchouc - roues multidirectionnelles \varnothing 125 mm.





DE Rohrrahmen 20x20 mm aus Edelstahl **AISI 304** - Ablageflächen aus Melamin mit umlaufendem Rahmen aus Edelstahl **AISI 304** - Gummistoßschutz - Mehrwegräder \varnothing 125 mm.





IT Struttura tubolare 20x20 mm in acciaio inox **AISI 304** - ripiani in nobilitato con cornice perimetrale in acciaio inox **AISI 304** - paracolpi in gomma - ruote multidirezionali \varnothing 125 mm.

EN Tubular structure 20x20 mm in stainless steel **AISI 304** - shelves in melamine with perimeter frame in stainless steel **AISI 304** - rubber shock absorber - multidirectional wheels \varnothing 125 mm.

FR Structure tubulaire 20x20 mm en acier inox **AISI 304** - étagères en mélaminé avec cadre périmétral en acier inox **AISI 304** - butoirs en caoutchouc - roues multidirectionnelles \varnothing 125 mm.

DE Rohrrahmen 20x20 mm aus Edelstahl **AISI 304** - Ablageflächen aus Melamin mit umlaufendem Rahmen aus Edelstahl **AISI 304** - Gummistoßschutz - Mehrwegräder \varnothing 125 mm.

	CA 1000 noce-walnut	CA 1000W wengé	CA 1001 noce-walnut	CA 1001W wengé
	83 x 57 x 97(h) cm		103 x 57 x 97(h) cm	
	2			
	72,4 x 50 cm		92,4 x 50 cm	
	60 Kg			
	360 €		380 €	

	CA 1050 noce-walnut	CA 1050W wengé	CA 1051 noce-walnut	CA 1051W wengé
	83 x 57 x 97(h) cm		103 x 57 x 97(h) cm	
	3			
	72,4 x 50 cm		92,4 x 50 cm	
	60 Kg			
	485 €		515 €	

Carrelli di servizio in acciaio inox e ripiani in nobilitato
Stainless steel service trolleys and melamine shelves

OPTIONAL



CA 1070 CA 1071



IT Struttura tubolare 20x20 mm in acciaio inox **AISI 304** - ripiani in nobilitato con cornice perimetrale in acciaio inox **AISI 304** - paracolpi in gomma - ruote multidirezionali \varnothing 125 mm.

EN Tubular structure 20x20 mm in stainless steel **AISI 304** - shelves in melamine with perimeter frame in stainless steel **AISI 304** - rubber shock absorber - multidirectional wheels \varnothing 125 mm.

FR Structure tubulaire 20x20 mm en acier inox **AISI 304** - étagères en mélaminé avec cadre périmétral en acier inox **AISI 304** - butoirs en caoutchouc - roues multidirectionnelles \varnothing 125 mm.

DE Rohrrahmen 20x20 mm aus Edelstahl **AISI 304** - Ablageflächen aus Melamin mit umlaufendem Rahmen aus Edelstahl **AISI 304** - Gummistoßschutz - Mehrwegräder \varnothing 125 mm.

	CA 1070 noce-walnut	CA 1071 noce-walnut
	83 x 57 x 172(h) cm	103 x 57 x 172(h) cm
	4	
	72,4 x 50 cm	92,4 x 50 cm
	60 Kg	
	640 €	670 €

Optional

A 512

Ruote con freno - Wheels with catch
Roues avec frein - Räder mit Bremse

CA 1000-1050-1070-1071
CA 1380-81-82-83-84-85-86-87-88-89-90-91-96
CA 1410-11-12-13-14-15-16-17-24-25-26-27

10 € cad./each

A 514

Ruote con freno - Wheels with catch
Roues avec frein - Räder mit Bremse

CA 1392P-93P-94P-95P

13 € cad./each

A 517

Ruote con freno - Wheels with catch
Roues avec frein - Räder mit Bremse

CA 1430-31-32-33

17 € cad./each



A 512

A 514

CA 1380
CA 1381

CA 1382
CA 1383

CA 1384
CA 1385



IT Struttura tubolare 20x20 mm in acciaio inox **AISI 304** - ripiani in acciaio inox **AISI 304** piegati, satinati, insonorizzati - paracolpi in gomma - ruote multidirezionali \varnothing 125 mm.

FR Structure tubulaire 20x20 mm en acier inox **AISI 304** - étagères en acier inox **AISI 304** pliées, satinées, insonorisées - butoirs en caoutchouc - roues multidirectionnelles \varnothing 125 mm.

EN Tubular structure 20x20 mm in stainless steel **AISI 304** - **AISI 304** stainless steel folded, satin-finished, soundproofed shelves - rubber shock absorber - multidirectional wheels \varnothing 125 mm.

DE Rohrrahmen 20x20 mm aus Edelstahl **AISI 304** - Gebogene, Schallgedämmte Ablageflächen aus Edelstahl **AISI 304** mit satiniertes Oberfläche - Gummistoßschutz - Mehrwegräder \varnothing 125 mm.

	CA 1380	CA 1381	CA 1382	CA 1383	CA 1384	CA 1385
						
	91 x 57 x 172(h) cm	111 x 57 x 172(h) cm	91 x 57 x 96(h) cm	111 x 57 x 96(h) cm	91 x 57 x 96(h) cm	111 x 57 x 96(h) cm
	4		2		3	
	80 x 50 cm	100 x 50 cm	80 x 50 cm	100 x 50 cm	80 x 50 cm	100 x 50 cm
	80 Kg		80 Kg		80 Kg	
	720 €	800 €	410 €	450 €	550 €	610 €

Carrelli di servizio in acciaio inox
Stainless steel service trolleys

CA 1390
CA 1391

CA 1410
CA 1411

CA 1412 - CA 1413
CA 1414



CA 1390



CA 1410



CA 1412

IT Struttura tubolare \varnothing 25 mm in acciaio inox **AISI 304** - ripiani in acciaio inox **AISI 304**, stampati in forma di vassoio con bordi arrotondati e alto spessore, insonorizzati e con finitura satinata - paracolpi in gomma - ruote multidirezionali \varnothing 125 mm.

FR Structure tubulaire \varnothing 25 mm en acier inox **AISI 304** - étagères en acier inox **AISI 304**, moulées en forme de plateau à bords arrondis et de grande épaisseur, insonorisées et satinées - butoirs en caoutchouc - roues multidirectionnelles \varnothing 125 mm.

EN Tubular structure \varnothing 25 mm in stainless steel **AISI 304** - **AISI 304** stainless steel shelves, tray-shaped with rounded edges and high thickness, soundproofed and with satin finish - rubber shock absorber - multidirectional wheels \varnothing 125 mm.

DE Rohrrahmen \varnothing 25 mm aus Edelstahl **AISI 304** - Schallgedämmte Ablageflächen aus Edelstahl **AISI 304**, Tablett förmig bedruckt mit abgerundeten Kanten und satinierte Oberfläche - Gummistoßschutz-Mehrwegräder \varnothing 125 mm.

	CA 1390	CA 1391	CA 1410	CA 1411	CA 1412	CA 1413	CA 1414
							
	90 x 60 x 94(h) cm	110 x 60 x 94(h) cm	90 x 60 x 104(h) cm	110 x 60 x 104(h) cm	100 x 70 x 94(h) cm	110 x 70 x 94(h) cm	128 x 70 x 94(h) cm
	2		3		2		
	80 x 50 cm	100 x 50 cm	80 x 50 cm	100 x 50 cm	90 x 60 cm	100 x 60 cm	120 x 60 cm
	100 Kg		100 Kg		100 Kg		
	370 €	415 €	490 €	550 €	442 €	470 €	600 €

CA 1415 - CA 1416 CA 1417



CA 1415

CA 1424 CA 1425



CA 1424

CA 1426 CA 1427



CA 1426

IT Struttura tubolare \varnothing 25 mm in acciaio inox **AISI 304** - ripiani in acciaio inox **AISI 304**, stampati in forma di vassoio con bordi arrotondati e alto spessore, insonorizzati e con finitura satinata - paracolpi in gomma - ruote multidirezionali \varnothing 125 mm.

EN Tubular structure \varnothing 25 mm in stainless steel **AISI 304** - **AISI 304** stainless steel shelves, tray-shaped with rounded edges and high thickness, soundproofed and with satin finish - rubber shock absorber - multidirectional wheels \varnothing 125 mm.

FR Structure tubulaire \varnothing 25 mm en acier inox **AISI 304** - étagères en acier inox **AISI 304**, moulées en forme de plateau à bords arrondis et de grande épaisseur, insonorisées et satinées - butoirs en caoutchouc - roues multidirectionnelles \varnothing 125 mm.

DE Rohrrahmen \varnothing 25 mm aus Edelstahl **AISI 304** - Schallgedämmte Ablageflächen aus Edelstahl **AISI 304**, Tablett förmig bedruckt mit abgerundeten Kanten und satiniertes Oberfläche - Gummistoßschutz-Mehrwegräder \varnothing 125 mm.

	CA 1415	CA 1416	CA 1417	CA 1424	CA 1425	CA 1426	CA 1427
							
	100 x 70 x 104(h) cm	110 x 70 x 104(h) cm	128 x 70 x 104(h) cm	90 x 60 x 140(h) cm	110 x 60 x 140(h) cm	90 x 60 x 170(h) cm	110 x 60 x 170(h) cm
	3			4		5	
	90 x 60 cm	100 x 60 cm	120 x 60 cm	80 x 50 cm	100 x 50 cm	80 x 50 cm	100 x 50 cm
	100 Kg			100 Kg		100 Kg	
	590 €	640 €	820 €	640 €	725 €	800 €	910 €

Carrelli di servizio in acciaio inox
Stainless steel service trolleys

OPTIONAL



CA 1390S - CA 1391S



CA 1390S

* Sacchi non inclusi.
Bags not included.
Sacs non fournis.
Säcke nicht enthalten.

h 52 cm

IT Portarifiuti. Carrelli di servizio in acciaio inox. Struttura tubolare \varnothing 25 mm in acciaio inox **AISI 304** - ripiani in acciaio inox **AISI 304** con fori per sacchi portarifiuti - paracolpi in gomma - ruote multidirezionali \varnothing 125 mm.

EN Garbage trolley. Stainless steel service trolleys. Tubular structure \varnothing 25 mm in stainless steel **AISI 304** - stainless steel **AISI 304** shelves with holes for garbage bags - rubber stop - multidirectional wheels \varnothing 125 mm.

FR Récipient à déchets. Chariots de service en acier inox Structure tubulaire \varnothing 25 mm en acier inox **AISI 304** - étagères en acier inox **AISI 304** avec trous pour sacs à déchets - butoir en caoutchouc - roues multidirectionnelles \varnothing 125 mm.

DE Abfallwagen. Servicewagen aus Edelstahl. Rohrrahmen \varnothing 25 mm aus Edelstahl **AISI 304** - Ablageflächen aus Edelstahl **AISI 304** mit Löchern für Abfallsäcke - Gummistoßschutz- Mehrwegräder \varnothing 125 mm.

i	CA 1390S	CA 1391S
cm	90 x 60 x 94(h) cm	110 x 60 x 94(h) cm
N.	2	
mm	80 x 50 cm	100 x 50 cm
MAX Kg	100 Kg	
	450 €	480 €

CA 1391S2



* Sacchi non inclusi.
Bags not included.
Sacs non fournis.
Säcke nicht enthalten.

h 52 cm

i	CA 1391S2
cm	110 x 60 x 94(h) cm
N.	2
mm	100 x 50 cm
MAX Kg	100 Kg
	550 €

CA 1152 - CA 1154



CA 1152W

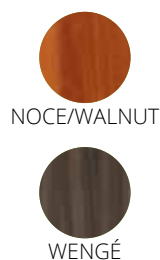

IT Carrelli di servizio con cupola. Struttura tubolare 20x20 mm in acciaio inox **AISI 304** - ripiani in nobilitato con cornice perimetrale in acciaio inox **AISI 304** - cupola in plexiglass semicircolare apribile su due lati - disponibile con ripiani colore noce o wengé - paracolpi in gomma - ruote multidirezionali \varnothing 125 mm.

EN Service trolleys with dome. Tubular structure 20x20 mm in stainless steel **AISI 304** - melamine shelves with stainless steel **AISI 304** perimeter frame - half-circle dome in Plexiglas that opens on two sides - available with walnut or wenge colour shelves - rubber shock absorber - multidirectional wheels \varnothing 125 mm.

FR Chariots de service avec clochette. Structure tubulaire 20x20 mm en acier inox **AISI 304** - étagères en mélaminé avec cadre périmétral en acier inox **AISI 304** - clochette en plexiglas semi-circulaire s'ouvrant sur deux côtés - disponible avec étagères en noyer ou wengé - butoir en caoutchouc - roues multidirectionnelles \varnothing 125 mm.

DE Servicewagen für Kuchen. Rohrrahmen 20x20 mm aus Edelstahl **AISI 304** - Ablageflächen aus Melamin mit umlaufendem Rahmen aus Edelstahl **AISI 304** - zweiseitig aufklappbare, halbrunde Plexiglashaube - mit Ablageflächen in Nussbaum- oder Wengé-Farbe erhältlich - Gummistoßschutz - Mehrwegräder \varnothing 125 mm.

i	CA 1152	CA 1152W	CA 1154	CA 1154W
cm	90 x 57 x 110(h) cm		111 x 57 x 110(h) cm	
N.	2			
MAX Kg	60 Kg			
	630 €		670 €	

CA 1390C - CA 1391C



CA 1390C

IT Carrelli di servizio con cupola. Struttura tubolare \varnothing 25 mm in acciaio inox **AISI 304** - ripiani in acciaio inox **AISI 304**, stampati, satinati e insonorizzati - cupola in plexiglass semicircolare apribile su due lati - paracolpi in gomma - ruote multidirezionali \varnothing 125 mm.

EN Service trolleys with dome. Tubular structure \varnothing 25 mm in stainless steel **AISI 304** - stainless steel **AISI 304** folded, satin-finished, soundproofed shelves - half-circle dome in Plexiglas that opens on two sides - rubber shock absorber - multidirectional wheels \varnothing 125 mm.

FR Chariots de service avec clochette. Structure tubulaire \varnothing 25 mm en acier inox **AISI 304** - étagères en acier inox **AISI 304** moulées, satinées, insonorisées - clochette en plexiglas semi-circulaire s'ouvrant sur deux côtés - butoir en caoutchouc - roues multidirectionnelles \varnothing 125 mm.

DE Servicewagen für Kuchen. Rohrrahmen \varnothing 25 mm aus Edelstahl **AISI 304** - vorgeformte schallgedämmte Ablageflächen aus Edelstahl **AISI 304** mit satinierter Oberfläche - zweiseitig aufklappbare, halbrunde Plexiglashaube - Gummistoßschutz - Mehrwegräder \varnothing 125 mm.

i	CA 1390C	CA 1391C
cm	90 x 60 x 109(h) cm	110 x 60 x 109(h) cm
N.	2	
MAX Kg	100 Kg	
	660 €	715 €

Carrelli di servizio in acciaio inox con cupola
Stainless steel service trolleys with dome

OPTIONAL



CA 1162 - CA 1163



CA 1162

IT Carrelli di servizio con cupola. Struttura tubolare 20x20 mm in acciaio inox **AISI 304** - ripiani in acciaio inox **AISI 304**, stampati, satinati e insonorizzati - coperchio in plexiglass 150(h) mm - paracolpi in gomma - ruote multidirezionali \varnothing 120 mm.

EN Service trolleys with dome. Tubular structure 20x20 mm in stainless steel **AISI 304** - stainless steel **AISI 304** folded, satin-finished, soundproofed shelves - Plexiglas lid 150(h) mm - rubber shock absorber - multidirectional wheels \varnothing 120 mm.

FR Chariots de service avec clochette. Structure tubulaire 20x20 mm en acier inox **AISI 304** - étagères en acier inox **AISI 304** moulées, satinées, insonorisées - couvercle en plexiglas 150(h) mm - butoir en caoutchouc - roues multidirectionnelles \varnothing 120 mm.

DE Servicewagen für Kuchen. Rohrrahmen 20x20 mm aus Edelstahl **AISI 304** - vorgeformte schallgedämmte Ablageflächen aus Edelstahl **AISI 304** mit satinierte Oberfläche - Deckel aus Plexiglas 150(h) mm - Gummistoßschutz- Mehrwegräder \varnothing 125 mm.

i	CA 1162	CA 1163
cm	118 x 57 x 104(h) cm	
N.	2	3
MAX Kg	80 Kg	
	725 €	885 €

CA 1165



IT Carrello di servizio in acciaio inox con piastre eutettiche refrigeranti. Struttura tubolare in acciaio inox **AISI 304** 20x20 mm - 8 piastre eutettiche refrigerate incluse - coperchio in plexiglass 150(h) mm - vasca e griglia in acciaio inox - predisposto per una capacità di n. 5 bacinelle GN1/4 e n. 5 bacinelle GN1/6 65(h) mm. Bacinelle non incluse nel prezzo.

EN Stainless steel service trolley with refrigerated electric plates. Tubular structure 20x20 mm in stainless steel **AISI 304** - 8 refrigerated eutectic plates included - Plexiglas lid 150(h) mm - stainless steel bowl and grid - equipped for up to 5 GN1/4 containers and 5 GN1/6 65(h) mm containers. Containers not included in the price.

FR Chariot de service en acier inox avec plaques de refroidissement électriques. Structure tubulaire en acier inox **AISI 304** 20x20 mm - 8 plaques eutectiques réfrigérées incluses - couvercle en plexiglas 150(h) mm - cuve et grille en acier inox - équipés pour une capacité de 5 bacs GN1/4 et 5 bacs GN1/6 65(h) mm. Bacs non compris dans le prix.

DE Edelstahl-Servicewagen mit elektrischen Kühlplatten. Rohrrahmen aus Edelstahl **AISI 304** 20x20 mm - 8 eutektische Kühlplatten im Lieferumfang enthalten - Plexiglasdeckel 150(h) mm - Edelstahlwanne und Gitter - enthält 5 GN1/4 Behälter mit 65(h) mm oder 5 GN1/6 Behälter mit 65(h) mm. Behälter nicht im Preis begriffen.

i	CA 1165
cm	108 x 57 x 104(h) cm
N.	2
MAX Kg	80 Kg
	1.200 €

CA 1388



IT Carrelli di servizio in acciaio inox per sbarazzo. Struttura tubolare in acciaio inox **AISI 304**, 20x20 mm - vasca in acciaio inox **AISI 304** - piano inferiore inox piegato - ruote multidirezionali \varnothing 125 mm.

EN Stainless steel service trolleys for disposal. Tubular structure in stainless steel **AISI 304**, 20x20 mm - stainless steel **AISI 304** bowl - lower folded stainless steel shelf - multidirectional wheels \varnothing 125 mm.

FR Chariots de service en acier inox pour le rangement. Structure tubulaire en acier inox **AISI 304**, 20x20 mm - cuve en acier inox **AISI 304** - plateau inférieur courbé en acier inox - roues multidirectionnelles \varnothing 125 mm.

DE Servicewagen aus Edelstahl zum Abräumen. Rohrrahmen aus Edelstahl **AISI 304**, 20x20 mm - Wanne aus Edelstahl **AISI 304** - Bodenfläche aus gebogenem Edelstahl - Mehrwegräder \varnothing 125 mm.

	CA 1388
	101 x 57 x 97(h) cm
	2
	90 x 50 cm
	1 x 150(h) mm
	80 Kg
	540 €

CA 1389









IT Carrelli di servizio in acciaio inox per sbarazzo. Struttura tubolare in acciaio inox **AISI 304**, 20x20 mm - vasche in acciaio inox **AISI 304** insonorizzate 150(h) mm - ruote multidirezionali \varnothing 125 mm.

EN Stainless steel service trolleys for disposal. Tubular structure in stainless steel **AISI 304**, 20x20 mm - stainless steel **AISI 304** soundproofed bowls 150(h) mm - multidirectional wheels \varnothing 125 mm.

FR Chariots de service en acier inox pour le rangement. Structure tubulaire en acier inox **AISI 304**, 20x20 mm - cuve en acier inox **AISI 304** insonorisées 150(h) mm - plateau inférieur courbé en acier inox - roues multidirectionnelles \varnothing 125 mm.

DE Servicewagen aus Edelstahl zum Abräumen. Rohrrahmen aus Edelstahl **AISI 304**, 20x20 mm - schallgedämmte Wanne aus Edelstahl **AISI 304** 150(h) mm - Mehrwegräder \varnothing 125 mm.

	CA 1389
	101 x 57 x 97(h) cm
	2
	90 x 50 cm
	2 x 150(h) mm
	80 Kg
	640 €

Carrelli di servizio in acciaio inox per sbarazzo
Stainless steel service trolleys for disposal

OPTIONAL



CA 1396



IT Carrelli di servizio in acciaio inox per sbarazzo. Struttura tubolare in acciaio inox **AISI 304**, 20x20 mm - vasche insonorizzate in acciaio inox **AISI 304**, 65(h) mm - ruote multidirezionali \varnothing 125 mm.

EN Stainless steel service trolleys for disposal. Tubular structure in stainless steel **AISI 304**, 20x20 mm - stainless steel **AISI 304** soundproofed bowls, 65(h) mm - multidirectional wheels \varnothing 125 mm.

FR Chariots de service en acier inox pour le rangement. Structure tubulaire en acier inox **AISI 304**, 20x20 mm - cuve en acier inox **AISI 304** insonorisées 65(h) mm - roues multidirectionnelles \varnothing 125 mm.

DE Servicewagen aus Edelstahl zum Abräumen. Rohrrahmen aus Edelstahl **AISI 304**, 20x20 mm - schallgedämmte Wanne aus Edelstahl **AISI 304** 65(h) mm - Mehrwegräder \varnothing 125 mm.

	CA 1396
	91 x 57 x 97(h) cm
	2
	90 x 50 cm
	2 x 65(h) mm
	80 Kg
	500 €

CA 1386 - CA 1387



CA 1386

IT Carrello portabacinelle con struttura tubolare tonda \varnothing 25 mm in acciaio inox **AISI 304** - livello superiore adatto a contenere fino a 3 bacinelle GN1/1 o 2 bacinelle GN1/1 - piano inferiore in acciaio inox **AISI 304**, piegato e insonorizzato - paracolpi in gomma - ruote multidirezionali \varnothing 125 mm. Bacinelle escluse.

EN Containers trolley with round tubular frame \varnothing 25 mm in stainless steel **AISI 304** - upper level designed to accommodate up to 3 GN1/1 or 2 GN1/1 containers - lower level in stainless steel **AISI 304**, folded and soundproofed - rubber shock absorber - multidirectional wheels \varnothing 125 mm. Containers not included.

FR Chariot porte-bacs avec structure tubulaire ronde \varnothing 25 mm en acier inox **AISI 304** - niveau supérieur pour 3 bacs GN1/1 ou 2 bacs GN1/1 - niveau inférieur en acier inox **AISI 304**, plié et insonorisé - butoir en caoutchouc - roues multidirectionnel \varnothing 125 mm. Bacs non compris

DE Behälterhalterwagen mit Rohrrahmen \varnothing 25 mm aus Edelstahl **AISI 304** - obere Ebene zur Aufnahme von bis zu 3 GN1/1 oder 2 GN1/1 Behälter - vorgeformte, schallgedämmte Bodenfläche aus Edelstahl - Gummistoßschutz - Mehrwegräder \varnothing 125 mm. Behälter nicht enthalten

	CA 1386	CA 1387
	77 x 62 x 97(h) cm	110 x 62 x 97(h) cm
	2	
	100 Kg	
	330 €	390 €

CA 1430



CA 1431



CA 1432







IT Carrelli di servizio inox per trasporto pesante. Struttura tubolare tonda \varnothing 25 mm, in acciaio inox **AISI 304** - ripiani in acciaio inox **AISI 304**, stampati in forma di vassoio con bordi arrotondati e alto spessore, insonorizzati e con finitura satinata - paracolpi in gomma - ruote multidirezionali \varnothing 125 mm.

EN Stainless steel service trolleys for heavy transport. Tubular structure \varnothing 25 mm in stainless steel **AISI 304** - **AISI 304** stainless steel shelves, tray-shaped with rounded edges and high thickness, soundproofed and with satin finish - rubber shock absorber - multidirectional wheels \varnothing 125 mm.

FR Chariots de service inox pour le transport de poids. Structure tubulaire ronde \varnothing 25 mm en acier inox **AISI 304** - étagères en acier inox **AISI 304**, moulées en forme de plateau à bords arrondis et de grande épaisseur, insonorisées et satinées - butoirs en caoutchouc - roues multidirectionnelles \varnothing 125 mm.

DE Servicewagen aus Edelstahl für Schwerlasten. Runder Rohrrahmen \varnothing 25 mm, aus Edelstahl **AISI 304** - Schallgedämmte Ablageflächen aus Edelstahl **AISI 304**, Tablett förmig bedruckt mit abgerundeten Kanten und satinierter Oberfläche - Gummistoßschutz- Mehrwegräder \varnothing 125 mm.

	CA 1430	CA 1431	CA 1432	CA 1433
 cm	110 x 60 x 100(h) cm		110 x 60 x 130(h) cm	110 x 60 x 160(h) cm
 N.	2	3	4	5
 mm	100 x 50 cm			
 MAX Kg	150 Kg			
	620 €	760 €	950 €	1.080 €

A richiesta spediti anche smontati.
On request also shipped disassembled.

CA 1433



Carrelli di servizio in acciaio inox per trasporto pesante
Stainless steel service trolleys for heavy transport

OPTIONAL



CA 1392P - CA 1393P



CA 1393P



A 514

OPTIONAL



IT Carrelli di servizio inox per trasporto pesante. Struttura tubolare in acciaio inox **AISI 304** 25x25 mm - ripiani in acciaio inox **AISI 304**, piegati con omega di rinforzo, satinati e insonorizzati - paracolpi in gomma - ruote multidirezionali \varnothing 125 mm.

EN Stainless steel service trolleys for heavy transport. Tubular structure 25x25 mm in stainless steel **AISI 304** - **AISI 304** stainless steel, folded shelves with support omega, satin-finished and soundproofed - rubber shock absorber - multidirectional wheels \varnothing 125 mm.

FR Chariots de service inox pour le transport de poids. Structure tubulaire 25x25 mm en acier inox **AISI 304** - étagères en acier inox **AISI 304** pliées avec renforcement oméga, satinées et insonorisées - butoirs en caoutchouc - roues multidirectionnelles \varnothing 125 mm.

DE Servicewagen aus Edelstahl für Schwerlasten. Rohrrahmen 25x25 mm aus Edelstahl **AISI 304** - mit Omega Verstärkung gebogene, schallgedämmte Ablageflächen aus Edelstahl **AISI 304** mit satiniertes Oberfläche - Gummistoßschutz - Mehrwegräder \varnothing 125 mm.

	CA 1392P	CA 1393P
	92 x 67 x 98(h) cm	112 x 67 x 98(h) cm
	2	
	80 x 60 cm	100 x 60 cm
	200 Kg	
	620 €	670 €

CA 1394P - CA 1395P



CA 1395P

	CA 1394P	CA 1395P
	92 x 67 x 98(h) cm	112 x 67 x 98(h) cm
	3	
	80 x 60 cm	100 x 60 cm
	200 Kg	
	860 €	950 €

CP 1008



CP 1010



A 1001	A 1002
Cestino piccolo / Small basket Petit panier / Klein Korb	Cestino grande / Big basket Grand panier / Gros Korb
12 €	28 €

IT Carrelli di servizio multiuso in plastica con montanti in alluminio anodizzato.

EN Multipurpose plastic service trolleys with anodised aluminium uprights.

FR Chariots polyvalente en plastique avec montants en aluminium anodisé.

DE Mehrzweck-Servicewagen aus Kunststoff mit Trägern aus eloxiertem Aluminium.

IT Carrelli di servizio multiuso in plastica.

EN Multipurpose plastic service trolleys.

FR Chariots polyvalente en plastique.

DE Mehrzweck-Servicewagen aus Kunststoff.

	CP 1008
	85 x 43 x 95(h) cm
	3
	40 Kg
	110 €

	CP 1010
	102 x 50 x 96(h) cm
	3
	40 Kg
	160 €

Carrelli di servizio multiuso in plastica
Multipurpose plastic service trolleys



Il carrello in foto è con optional A1001 e A1002
The trolley shown is equipped with optional A1001 and A1002
Le chariot illustré est équipé avec A1001 et A1002
Der abgebildete Wagen ist mit A1001 und A1002ausgestattet



Carrelli ed Espositori refrigerati e termici in legno

WOODEN REFRIGERATED
AND HEATED TROLLEYS AND DISPLAYS
CHARIOTS ET PRÉSENTOIRS
EN BOIS RÉFRIGÉRÉS ET THERMIQUES
KÜHL- UND HEIZWAGEN
UND -DISPLAYS AUS HOLZ

CLR 2788NW



IT Carrelli refrigerati in legno con cupola in plexiglass. Struttura in legno multistrato di betulla - cupola semicircolare in plexiglass - refrigerazione statica - modelli con 2 mensole ripieghevoli - colore noce o wengé - ruote multidirezionali \varnothing 100 mm. Bacinelle escluse - le temperature di lavoro indicate sono da considerarsi con coperchi posizionati.

EN Wooden refrigerated trolleys with Plexiglas dome. Multi-layered birch wood structure - half-round Plexiglas dome - static refrigeration - two foldable shelves models - walnut or wenge colour - multidirectional wheels \varnothing 100 mm. Basins excluded - the indicated working temperatures are to be considered with positioned lids.

FR Chariots réfrigérés en bois avec clochette en plexiglas. Structure en multicouche de bouleau - clochette en plexiglas semi-circulaire - réfrigération statique - modèles avec 2 étagères escamotables - couleur noyer ou wengé - roues multidirectionnelles \varnothing 100 mm. Bacs non compris - les températures de travail indiquées sont à considérer avec couvercles en place.

DE Kühlwagen aus Holz mit Plexiglashaube. Birkensterrholzstruktur - halbrunde Plexiglashaube - statische Kühlung - Modelle mit 2 Faltflächen - erhältlich in Walnuss oder Wenge - Mehrwegräder \varnothing 100 mm. Behälter nicht enthalten - die angegebenen Arbeitstemperaturen sind bei aufgesetzten Deckeln zu verstehen.

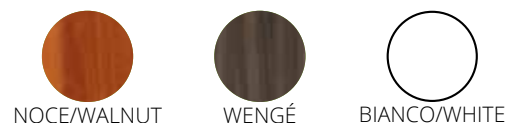

	CLR 2788N noce-walnut	CLR 2788NW wengé	CLR 2788NB bianco-white	CLR 2788NBT noce-walnut	CLR 2788NBTW wengé	CLR 2788NBTB bianco-white
	230V - 50Hz					
	+2°C +10°C			-5°C +5°C		
	R600a					
	3 x GN1/1 - 150(h) mm					
	3.495 €	3.720 €	3.720 €	3.850 €	3.850 €	3.940 €

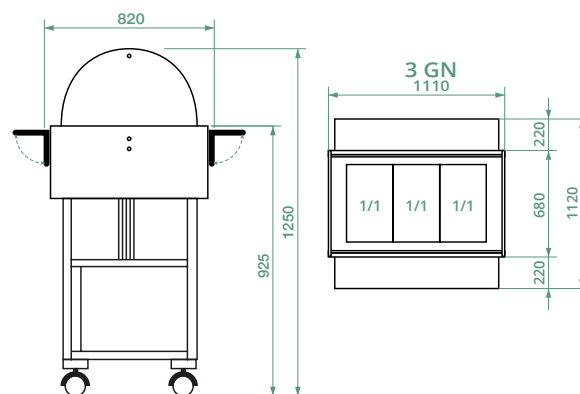

Carrelli refrigerati in legno
Wooden refrigerated trolleys

OPTIONAL



CLR 2787N



IT Carrelli refrigerati in legno con cupola in plexiglass. Struttura in legno multistrato di betulla - cupola semicircolare in plexiglass - refrigerazione statica - modelli disponibili con 1 mensola ripieghevole e 1 piano di appoggio - colore noce o wengé - ruote multidirezionali ø 100 mm. Bacinelle escluse - le temperature di lavoro indicate sono da considerarsi con coperchi posizionati.

EN Wooden refrigerated trolleys with Plexiglas dome. Multi-layered birch wood structure - half-round Plexiglas dome - static refrigeration - models with foldable shelf and support base - walnut or wenge colour - multidirectional wheels ø 100 mm. Containers not included - the operating temperatures listed are to be considered with lids on.

FR Chariots réfrigérés en bois avec clochette en plexiglas. Structure en multicouche de bouleau - clochette en plexiglas semi-circulaire - réfrigération statique - modèles avec 1 étagère et plan de travail - couleur noyer ou wengé - roues multidirectionnelles ø 100 mm. Bacs non compris - les températures de travail indiquées sont à considérer avec couvercles en place.

DE Kühlwagen aus Holz mit Plexiglashaube. Birkensperrholzstruktur - halbrunde Plexiglashaube - statische Kühlung - Modelle mit 1 Faltfläche und 1 Ablagefläche - erhältlich in Walnuss oder Wenge - Mehrwegräder ø 100 mm. Behälter nicht enthalten - die angegebenen Arbeitstemperaturen sind bei aufgesetzten Deckeln zu verstehen.







NOCE/WALNUT

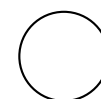

WENGÉ



BIANCO/WHITE

	CLR 2787N noce-walnut	CLR 2787NW wengé	CLR 2787NB bianco-white	CLR 2787NBT noce-walnut	CLR 2787NBTW wengé	CLR 2787NBTB bianco-white
						
 1 Ph	230V - 50Hz					
	+2°C +10°C			-5°C +5°C		
	R600a					
	3 x GN1/1 - 150(h) mm					
	3.470 €	3.685 €		3.800 €		4.010 €

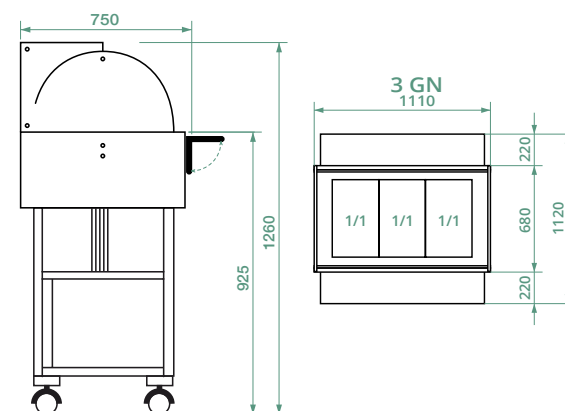

CLR 2786NB

NEW



IT Carrelli refrigerati in legno con luce al neon. Struttura in legno multistrato di betulla - cupola in plexiglass - refrigerazione statica - 2 mensole ripieghevoli - disponibili nei colori noce o wengé - 1 luce al neon - ruote multidirezionali Ø 100 mm. Bacinelle escluse - le temperature di lavoro indicate sono da considerarsi con coperchi posizionati.

EN Refrigerated wooden trolleys with neon light. Multi-layered birch wood structure - half-round Plexiglas dome - static refrigeration - 2 foldable shelves - available in walnut or wenge colour - 1 neon light - multidirectional wheels Ø 100 mm. Containers not included - the operating temperatures listed are to be considered with lids on.

FR Chariots réfrigérés en bois avec lampe néon. Structure en multicouche de bouleau - clochette en plexiglas - réfrigération statique - 2 étagères escamotables - couleur noyer ou wengé - 1 lampe néon - roues multidirectionnelles Ø 100 mm. Bacs non compris - les températures de travail indiquées sont à considérer avec couvercles en place.

DE Kühlwagen aus Holz mit Neonlampe. Birkensperrholzstruktur - Plexiglashaube - statische Kühlung - 2 Faltflächen- erhältlich in Walnuss oder Wenge - 1 Neonlampe - Mehrwegräder Ø 100 mm. Behälter nicht enthalten - die angegebenen Arbeitstemperaturen sind bei aufgesetzten Deckeln zu verstehen.



NOCE/WALNUT



WENGÉ



BIANCO/WHITE

	CLR 2786N noce-walnut	CLR 2786NW wengé	CLR 2786NB bianco-white	CLR 2786NBT noce-walnut	CLR 2786NBTW wengé	CLR 2786NBTB bianco-white
	230V - 50Hz					
	+2°C +10°C			-5°C +5°C		
	R600a					
	3 x GN1/1 - 150(h) mm					
	3.640 €	3.810 €		3.930 €		4.210 €

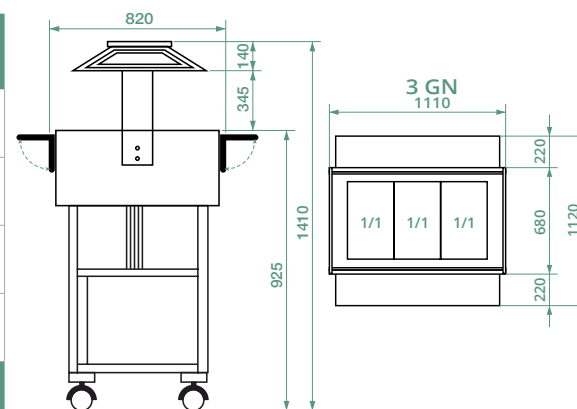

Carrelli refrigerati in legno
Wooden refrigerated trolleys

OPTIONAL



ELR 2827



ELR 2827BTW

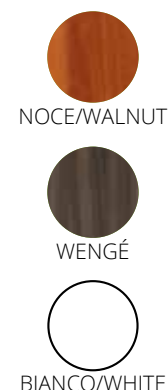



IT Espositori refrigerati in legno con cupola. Struttura in legno multistrato di betulla - cupola semicircolare in plexiglass - refrigerazione statica - disponibili con 2 mensole ripieghevoli - colore noce o wengé - ruote multidirezionali \varnothing 75 mm. Bacinelle escluse - le temperature di lavoro indicate sono da considerarsi con coperchi posizionati.

FR Présentoirs réfrigérés en bois avec clochette. Structure en multicouche de bouleau - clochette en plexiglas semi-circulaire - réfrigération statique - modèles avec 2 étagères escamotables - couleur noyer ou wengé - roues multidirectionnelles \varnothing 75 mm. Bacs non compris - les températures de travail indiquées sont à considérer avec couvercles en place.

EN Refrigerated wooden displays with dome. Multi-layered birch wood structure - half-round Plexiglas dome - static refrigeration - two foldable shelves models - walnut or wenge colour - multidirectional wheels \varnothing 75 mm. Containers not included - the operating temperatures listed are to be considered with lids on.

DE Kühlvitrinen aus Holz mit Haube. Birkensperrholzstruktur - halbrunde Plexiglashaube - statische Kühlung - mit 2 Faltflächen- erhältlich in Walnuss oder Wenge - Mehrwegräder \varnothing 75 mm. Behälter nicht enthalten - die angegebenen Arbeitstemperaturen sind bei aufgesetzten Deckeln zu verstehen.

	ELR 2827 noce-walnut	ELR 2827W wengé	ELR 2827B bianco-white	ELR 2827BT noce-walnut	ELR 2827BTW wengé	ELR 2827BTB bianco-white
						
	230V - 50Hz					
	+2°C +10°C			-5°C +5°C		
	R600a					
	4 x GN1/1 - 150(h) mm					
	3.640 €		3.820 €		4.000 €	4.190 €

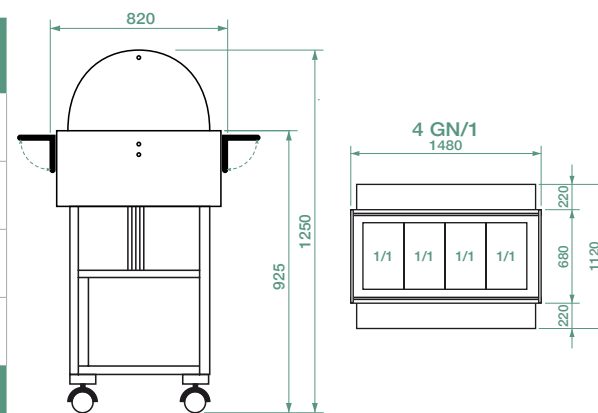

ELR 2826



ELR 2826BTW

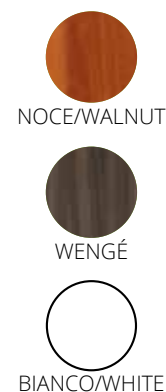





IT Espositori refrigerati in legno con cupola. Struttura in legno multistrato di betulla - cupola semicircolare in plexiglass - refrigerazione statica - disponibili con 1 mensola ripieghevole e 1 piano di appoggio - colore noce o wengé - ruote multidirezionali Ø 75 mm. Bacinelle escluse - le temperature di lavoro indicate sono da considerarsi con coperchi posizionati.

FR Présentoirs réfrigérés en bois avec clochette. Structure en multicouche de bouleau - clochette en plexiglas semi-circulaire - réfrigération statique - avec 1 étagère escamotable et plan de travail - couleur noyer ou wengé - roues multidirectionnelles Ø 75 mm. Bacs non compris - les températures de travail indiquées sont à considérer avec couvercles en place.

EN Refrigerated wooden displays with dome. Multi-layered birch wood structure - half-round Plexiglas dome - static refrigeration - models with 1 foldable shelf and 1 support base - walnut or wenge colour - multidirectional wheels Ø 75 mm. Containers not included - the operating temperatures listed are to be considered with lids on.

DE Kühlvitrinen aus Holz mit Haube. Birkensperrholzstruktur - halbrunde Plexiglashaube - statische Kühlung - Modelle mit 1 faltfläche und 1 Ablagefläche - erhältlich in Walnuss oder Wenge - Mehrwegräder Ø 75 mm. Behälter nicht enthalten - die angegebenen Arbeitstemperaturen sind bei aufgesetzten Deckeln zu verstehen.

	ELR 2826 noce-walnut	ELR 2826W wengé	ELR 2826B bianco-white	ELR 2826BT noce-walnut	ELR 2826BTW wengé	ELR 2826BTB bianco-white
						
 1 Ph	230V - 50Hz					
	+2°C +10°C			-5°C +5°C		
	R600a					
 N.	4 x GN1/1 - 150(h) mm					
	3.615 €		3.820 €		3.970 €	4.165 €

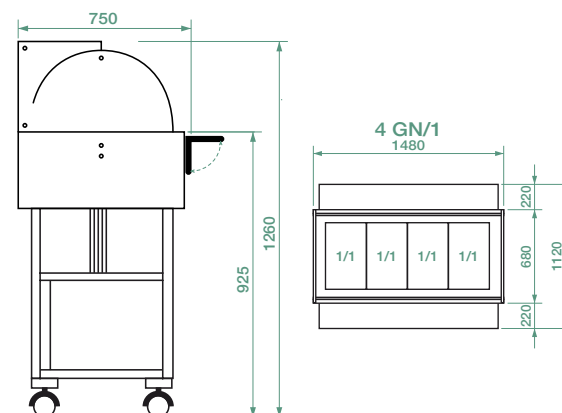

Espositori refrigerati in legno
Wooden refrigerated displays

OPTIONAL



ELR 2825



IT Espositori refrigerati in legno con luce al neon. Struttura in legno multistrato di betulla - cupola in plexiglass - refrigerazione statica - 2 mensole ripieghevoli - disponibile nei colori noce o wengé - 1 luce al neon - ruote multidirezionali ø 75 mm. Bacinelle escluse - le temperature di lavoro indicate sono da considerarsi con coperchi posizionati.

EN Refrigerated wooden displays with neon light. Multi-layered birch wood structure - Plexiglas dome - static refrigeration - 2 foldable shelves - available in walnut or wenge colour - 1 neon light - multidirectional wheels ø 75 mm. Containers not included - the operating temperatures listed are to be considered with lids on.

ELR 2825BTW



FR Présentoirs réfrigérés en bois avec lampe néon. Structure en multicouche de bouleau - clochette en plexiglas - réfrigération statique - 2 étagères escamotables - disponible en couleur noyer ou wengé - 1 lampe néon - roues multidirectionnelles ø 75 mm. Bacs non compris - les températures de travail indiquées sont à considérer avec couvercles en place.

DE Kühlvitrinen aus Holz mit Neonlampe. Birkensperrholzstruktur - Plexiglashaube - statische Kühlung - 2 Falflächen- erhältlich in Walnuss oder Wenge - 1 Neonlampe - Mehrwegräder ø 75 mm. Behälter nicht enthalten - die angegebenen Arbeitstemperaturen sind bei aufgesetzten Deckeln zu verstehen.

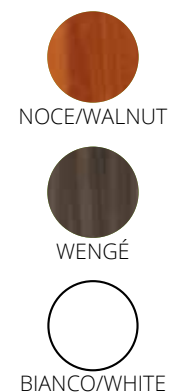

	ELR 2825 noce-walnut	ELR 2825W wengé	ELR 2825B bianco-white	ELR 2825BT noce-walnut	ELR 2825BTW wengé	ELR 2825BTB bianco-white
						
	230V - 50Hz					
	+2°C +10°C			-5°C +5°C		
	R600a					
	4 x GN1/1 - 150(h) mm					
	3.810 €		3.910 €		4.235 €	4.250 €

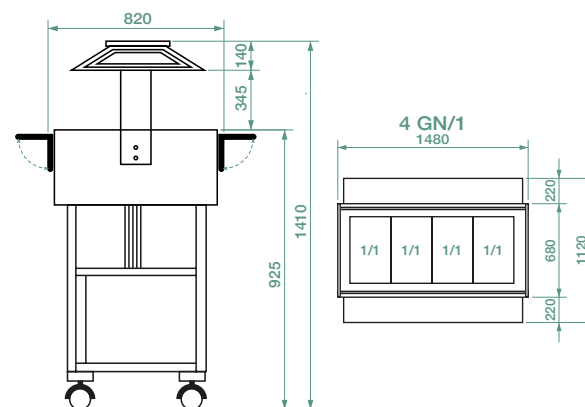

CL 2777NW



IT Carrelli termico a bagnomaria in legno, con cupola. Struttura in legno multistrato di betulla - cupola semicircolare in plexiglass - riscaldato con resistenza elettrica- disponibili con 2 mensole ripieghevoli - colore noce o wengé - ruote multidirezionali ø 100 mm. Bacinelle escluse - le temperature di lavoro indicate sono da considerarsi con coperchi posizionati.

EN Wooden heated bain-marie trolleys with dome. Multi-layered birch wood structure - half-round Plexiglas dome - electric heating element - available with two foldable shelves - walnut or wenge colour - multidirectional wheels ø 100 mm. Containers not included - the operating temperatures listed are to be considered with lids on.

FR Wooden heated bain-marie trolleys with dome. Multi-layered birch wood structure - half-round Plexiglas dome - electric heating element - available with two foldable shelves - walnut or wenge colour - multidirectional wheels ø 100 mm. Containers not included - the operating temperatures listed are to be considered with lids on.

DE Bain-Marie Heizwagen aus Holz mit Haube. Birkensperrholzstruktur - halbrunde Plexiglashaube - mit elektrischem Heizstab beheizt - mit 2 faltflächen- erhältlich in Walnuss oder Wenge - Mehrwegräder ø 100 mm. Behälter nicht enthalten - die angegebenen Arbeitstemperaturen sind bei aufgesetzten Deckeln zu verstehen.







NOCE/WALNUT



WENGÉ



BIANCO/WHITE

	CL 2777N noce-walnut	CL 2777NW wengé	CL 2777NB bianco-white
	2000 W		
	230V - 50Hz		
	+30°C +90°C		
	3 x GN1/1 - 150(h) mm		
	2.550 €		2.715 €

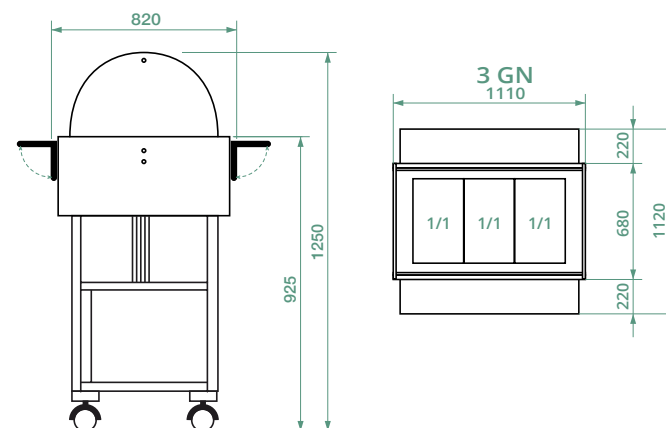

Carrelli termici a bagnomaria in legno
Wooden bain-marie trolleys

OPTIONAL



65



57

CL 2778N



IT Carrelli termico a bagnomaria in legno, con cupola. Struttura in legno multistrato di betulla - cupola semicircolare in plexiglass - riscaldato con resistenza elettrica - disponibili con 1 mensola ripieghevole e 1 piano di appoggio - colore noce o wengé - ruote multidirezionali ø 100 mm. Bacinelle escluse - le temperature di lavoro indicate sono da considerarsi con coperchi posizionati.

EN Wooden heated bain-marie trolleys with dome. Multi-layered birch wood structure - half-round Plexiglas dome - electric heating element - available with 1 foldable shelf and 1 support base - walnut or wenge colour - multidirectional wheels ø 100 mm. Containers not included - the operating temperatures listed are to be considered with lids on.

FR Chariots bain-marie chauffants en bois avec clochette. Structure en multicouche de bouleau - clochette en plexiglas semi-circulaire - chauffé par résistance électrique - disponibles avec 1 étagère escamotable et 1 plan de travail - couleur noyer ou wengé - roues multidirectionnelles ø 100 mm. Bacs non compris - les températures de travail indiquées sont à considérer avec couvercles en place.

DE Bain-Marie Heizwagen aus Holz mit Haube. Birkensperrholzstruktur - halbrunde Plexiglashaube - mit elektrischem Heizstab beheizt - mit 1 Falfläche und 1 Ablagefläche - erhältlich in Walnuss oder Wenge - Mehrwegräder ø 100 mm. Behälter nicht enthalten - die angegebenen Arbeitstemperaturen sind bei aufgesetzten Deckeln zu verstehen.

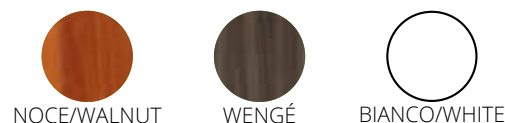

	CL 2778N noce-walnut	CL 2778NW wengé	CL 2778NB bianco-white
		2000 W	
		230V - 50Hz	
		+30°C +90°C	
		3 x GN1/1 - 150(h) mm	
	2.520 €		2.710 €

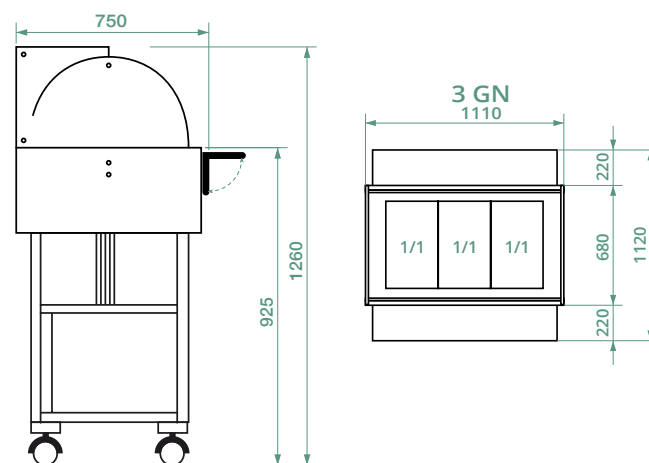

CL 2774NW



IT Carrello termico a bagnomaria in legno, da buffet. Struttura in legno multistrato di betulla - cupola in plexiglass - luce al neon - riscaldato con resistenza elettrica - disponibili con 2 mensole ripieghevoli colore noce o wengé - ruote multidirezionali ø 100 mm. Bacinelle escluse - le temperature di lavoro indicate sono da considerarsi con coperchi posizionati.

EN Wooden heated bain-marie trolley, for buffet. Multi-layered birch wood structure - half-round Plexiglas dome - neon light - electric heating element - available with two foldable shelves - walnut or wenge colour - multidirectional wheels ø 100 mm. Containers not included - the operating temperatures listed are to be considered with lids on.

FR Chariots bain-marie chauffants en bois, pour buffet. Structure en multicouche de bouleau - clochette en plexiglas - lampe néon - chauffé par résistance électrique - disponibles avec 2 étagères escamotables - couleur noyer ou wengé - roues multidirectionnelles ø 100 mm. Bacs non compris - les températures de travail indiquées sont à considérer avec couvercles en place.

DE Bain-Marie Heizwagen aus Holz für Buffets. Birkensperrholzstruktur - Plexiglashaube - Neonlampe - mit elektrischem Heizstab beheizt - mit 2 faltbaren Flächen - erhältlich in Walnuss oder Wenge - Mehrwegräder ø 100 mm. Behälter nicht enthalten - die angegebenen Arbeitstemperaturen sind bei aufgesetzten Deckeln zu verstehen.



NOCE/WALNUT



WENGÉ



BIANCO/WHITE

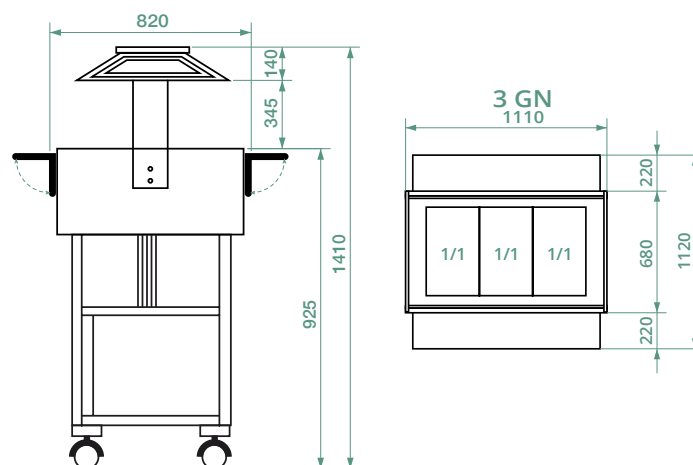

	CL 2774N noce-walnut	CL 2774NW wengé	CL 2774NB bianco-white
		2000 W	
		230V - 50Hz	
		+30°C +90°C	
		3 x GN1/1 - 150(h) mm	
	2.710 €		2.940 €

Carrelli termici a bagnomaria in legno
Wooden heated bain-marie trolleys

OPTIONAL



65

59

CL 2772N



IT Carrello termico a bagnomaria in legno. Struttura in legno multistrato di betulla - 1 mensola ripieghevole - disponibile in colore noce - ruote multidirezionali ø 100 mm. Bacinelle escluse - le temperature di lavoro indicate sono da considerarsi con coperchi posizionati.

EN Wooden heated bain-marie trolley Multi-layered birch wood structure - 1 folding shelf - available in walnut colour - multidirectional wheels ø 100 mm. Containers not included - the operating temperatures listed are to be considered with lids on.

FR Chariots bain-marie chauffants en bois. Structure en bois massif - 1 étagère escamotable - disponible en couleur noyer - roues multidirectionnelles de ø 100 mm. Bacs non compris - les températures de travail indiquées sont à considérer avec couvercles en place.

DE Bain-Marie Heizwagen aus Holz. Birkensperrholzstruktur - 1 Faltfläche - erhältlich in Walnussfarbe - Mehrwegräder ø 100 mm. Behälter nicht enthalten - die angegebenen Arbeitstemperaturen sind bei aufgesetzten Deckeln zu verstehen.



	CL 2772N noce-walnut
	2000 W
	230V - 50Hz
	+30°C +90°C
	3 x GN1/1 - 150(h) mm
	123 x 70 x 135(h) cm
	2.220 €



ELC 2832



ELC 2832W

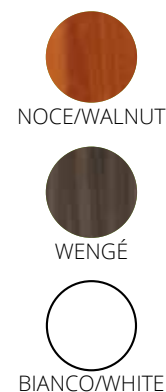

IT Espositore termico a bagnomaria in legno, con cupola. Struttura in legno multistrato di betulla - cupola semicircolare in plexiglass - riscaldato con resistenza elettrica- disponibili con 2 mensole ripieghevoli - colore noce o wengé - ruote multidirezionali \varnothing 75 mm. Bacinelle escluse - le temperature di lavoro indicate sono da considerarsi con coperchi posizionati.

FR Présentoir bain-marie chauffants en bois avec clochette. Structure en multicouche de bouleau - clochette en plexiglas semi-circulaire - chauffé par résistance électrique - disponibles avec 2 étagères escamotables - couleur noyer ou wengé - roues multidirectionnelles \varnothing 75 mm. Bacs non compris - les températures de travail indiquées sont à considérer avec couvercles en place.

EN Wooden heated bain-marie display with dome. Multi-layered birch wood structure - half-round Plexiglas dome - electric heating element - available with two foldable shelves - walnut or wenge colour - multidirectional wheels \varnothing 75 mm. Containers not included - the operating temperatures listed are to be considered with lids on.

DE Bain-Marie Heizvitrine aus Holz mit Haube. Birkensperrholzstruktur - halbrunde Plexiglashaube - mit elektrischem Heizstab beheizt - mit 2 Faltflächen- erhältlich in Walnuss oder Wenge - Mehrwegräder \varnothing 75 mm. Behälter nicht enthalten - die angegebenen Arbeitstemperaturen sind bei aufgesetzten Deckeln zu verstehen.

	ELC 2832 noce-walnut	ELC 2832W wengé	ELC 2832B bianco-white
		2000 W	
		230V - 50Hz	
		+30°C +90°C	
		4 x GN1/1 - 150(h) mm	
	2.700 €		2.870 €

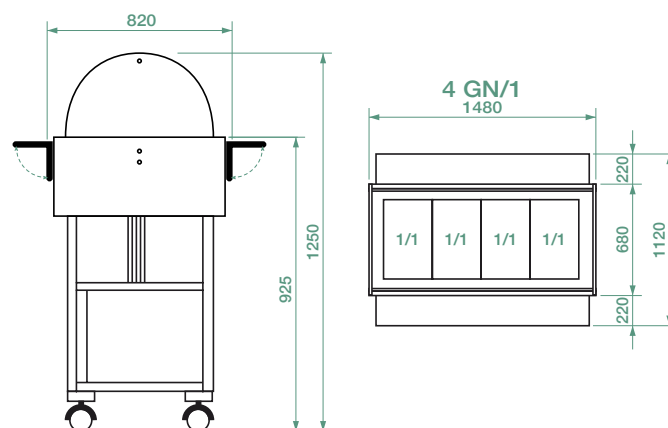

Espositori termici a bagnomaria in legno
Wooden heated bain-marie displays

OPTIONAL



ELC 2834B

NEW



ELC 2834

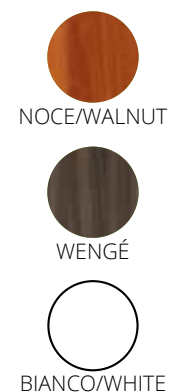

IT Espositore termico a bagnomaria in legno, con cupola. Struttura in legno multistrato di betulla - cupola semicircolare in plexiglass - riscaldato con resistenza elettrica - disponibili con 1 mensola ripieghevole e 1 piano di appoggio - colore noce o wengé - ruote multidirezionali \varnothing 75 mm. Bacinelle escluse - le temperature di lavoro indicate sono da considerarsi con coperchi posizionati.

FR Présentoir bain-marie chauffants en bois avec clochette. Structure en multicouche de bouleau - clochette en plexiglas semi-circulaire - chauffé par résistance électrique - disponibles avec 1 étagère escamotable et 1 plan de travail - couleur noyer ou wengé - roues multidirectionnelles \varnothing 75 mm. Bacs non compris - les températures de travail indiquées sont à considérer avec couvercles en place.

EN Wooden heated bain-marie display with dome. Multi-layered birch wood structure - half-round Plexiglas dome - electric heating element - available with 1 foldable shelf and 1 support base - walnut or wengé colour - multidirectional wheels \varnothing 75 mm. Containers not included - the operating temperatures listed are to be considered with lids on.

DE Bain-Marie Heizvitrine aus Holz mit Haube. Birkensperrholzstruktur - halbrunde Plexiglashaube - mit elektrischem Heizstab beheizt - mit 1 Faltfläche und 1 Ablagefläche - erhältlich in Walnuss oder Wenge - Mehrwegräder \varnothing 75 mm. Behälter nicht enthalten - die angegebenen Arbeitstemperaturen sind bei aufgesetzten Deckeln zu verstehen.

	ELC 2834 noce-walnut	ELC 2834W wengé	ELC 2834B bianco-white
	2000 W		
	230V - 50Hz		
	+30°C +90°C		
	4 x GN1/1 - 150(h) mm		
	2.900 €		3.010 €

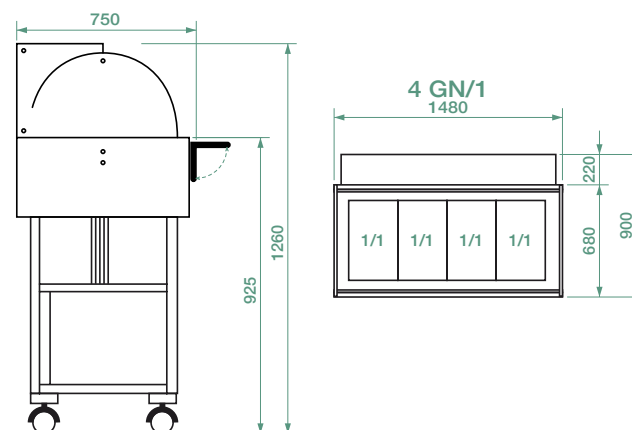

ELC 2828



IT Espositore termico a bagnomaria in legno, con luce al neon. Struttura in legno multistrato di betulla - cupola in plexiglass - luce al neon - riscaldato con resistenza elettrica - disponibili con 2 mensole ripieghevoli - colore noce o wengé - ruote multidirezionali ø 75 mm. Bacinelle escluse - le temperature di lavoro indicate sono da considerarsi con coperchi posizionati.

EN Wooden heated bain-marie display with neon light. Multi-layered birch wood structure - half-round Plexiglas dome - neon light - electric heating element - available with two foldable shelves - walnut or wengè colour - multidirectional wheels ø 75 mm. Containers not included - the operating temperatures listed are to be considered with lids on.

ELC 2828W



FR Présentoir bain-marie chauffants en bois, avec lampe néon. Structure en multicouche de bouleau - clochette en plexiglas - lampe néon - chauffé par résistance électrique - disponibles avec 2 étagères escamotables - couleur noyer ou wengè - roues multidirectionnelles ø 75 mm. Bacs non compris - les températures de travail indiquées sont à considérer avec couvercles en place.

DE Bain-Marie Heizvitrine aus Holz mit Neonlampe. Birkensperrholzstruktur - Plexiglashaube - Neonlampe - mit elektrischem Heizstab beheizt - mit 2 Faltflächen- erhältlich in Walnuss oder Wenge - Mehrwegräder ø 75 mm. Behälter nicht enthalten - die angegebenen Arbeitstemperaturen sind bei aufgesetzten Deckeln zu verstehen.

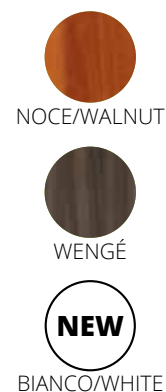

	ELC 2828 noce-walnut	ELC 2828W wengé	ELC 2828B bianco-white
	2000 W		
	230V - 50Hz		
	+30°C +90°C		
	4 x GN1/1 - 150(h) mm		
	2.885 €		3.120 €

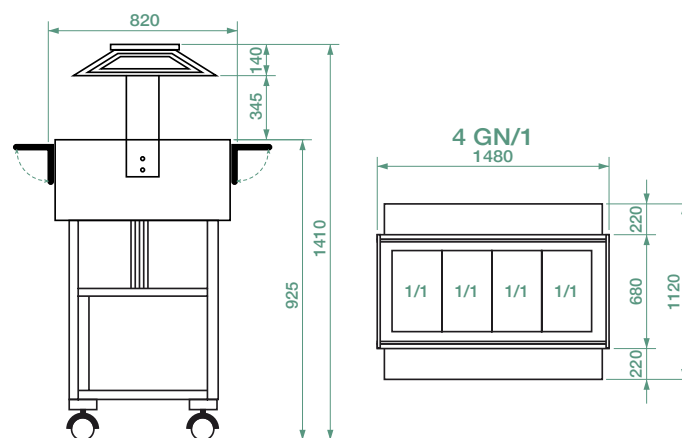

OPTIONAL



ELN 2835

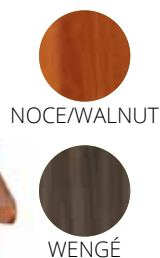

- IT** Espositore in legno neutro. Struttura in multistrato di betulla - cupola in plexiglas - piano in acciaio inox **AISI 304** - dotato di 2 mensole ripieghevoli - ruote multidirezionali ø 75 mm.
- EN** Display in neutral wood. Multi-layered birch wood structure - Plexiglas dome - top in stainless steel **AISI 304** - with 2 folding shelves - multidirectional wheels ø 75 mm.
- FR** Présentoir en bois neutre. Structure en en bouleau multicouche - clochette en plexiglas - plan de travail en acier inox **AISI 304** - avec 2 étagères escamotables - roues multidirectionnelles ø 75 mm.
- DE** Neutral Vitrine aus Holz. Birkensperrholzstruktur - Plexiglashaube - Fläche aus Edelstahl **AISI 304** - mit 2 faltflächen - Mehrwegräder ø 75 mm.

	ELN 2835 noce-walnut	ELN 2835W wengé
	147 x 82 x 141(h) cm	
	2.280 €	

CL2770N

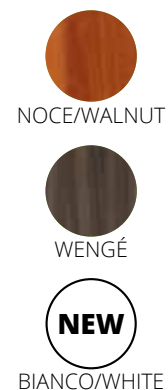

CL 2770

- IT** Carrello termico in legno, ideale per bolliti e arrostiti. Struttura portante in legno multistrato di betulla - vasca in acciaio inox **AISI 304** munita di scarico. Bacinelle escluse
- EN** Wooden heated trolley, ideal for boiled and roasted meats. Multi-layered birch wood structure - stainless steel **AISI 304** bowl with drain. Containers not included.
- FR** Chariot chauffant en bois, idéal pour les viandes bouillies et rôties. Structure portante en multicouche de bouleau - cuve en acier inox **AISI 304** avec vidange. Bacs non compris
- DE** Heizwagen aus Holz, ideal für gekochtes und gebratenes Fleisch. Birkensperrholztragstruktur - Becken aus Edelstahl **AISI 304** mit Ablauf. Behälter nicht enthalten

	CL 2770N noce-walnut	CL 2770NW wengé	CL 2770NB bianco-white
	2000 W		
	230V - 50Hz		
	+30°C +90°C		
	3x GN/1/1 150(h) mm		
	123 x 65 x 95(h) cm		
	1.930 €		2.075 €

Carrello termico, ideale per bolliti e arrostiti
Heated trolley, ideal for boiled and roasted meats

Carrelli di servizio in legno Wooden service trolleys

	CLR311
Mod.	CLR 2788 - 2787 - 2786 - 2777 - 2778 2774 - 2772 - 2770
	Vasca inox forata Stainless steel perforated container Bac inox perforée Behälter aus rostfreiem Stahl mit Löcher
	GN3x1/1 - 100(h) mm
	160 €

	CF411
Mod.	ELR 2827 - 2826 - 2825 - 2832 2834 - 2828 - 2835
	Vasca inox forata Perforated stainless steel bowl Cuve perforée en acier inox Gelochte Edelstahlwanne
	GN4x1/1 - 100(h) mm
	180 €

Solo per modello CL2770 For CL2770 model only

A 580
Portacoperchi inox Stainless steel lid holder Porte-couvercle en acier inox Edelstahl-Deckelhalter
115 €

A 590
Portacoltelli Knives holder Porte-couteaux Messerhalter
70 €

A 600
Scorrevole portapiatti con tagliere polietilene Sliding plate holder with polyethylene chopping board Porte-plat coulissant avec planche en polyéthylène Gleitplattenhalter mit Polyethylen-Schneidebrett
170 €

Mensole in legno per unione

CONNECTION WOODEN SHELF - ÉTAGÈRES EN BOIS POUR RACCORDS - VERBINDUNGSREGALE AUS HOLZ

MLUN



ANUN



MLUNW

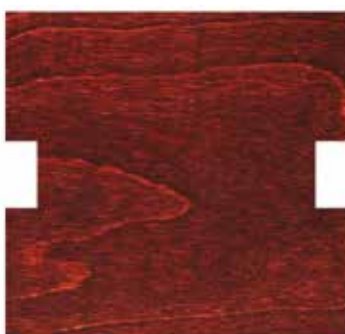

ANUNW



PER MODELLI / FOR MODEL

CLR 2782			CL 2770
CLR 2784	ELR 2825	ELC 2828	CL 2772
CLR 2786	ELR 2826	ELC 2832	CL 2774
CLR 2787	ELR 2827	ELC 284	CL 2777
CLR 2788			CL 2778

i	MLUN	MLUNW	ANUN	ANUNW
↗ cm	68 x 70 cm		88 x 88 cm	
	170 €		210 €	

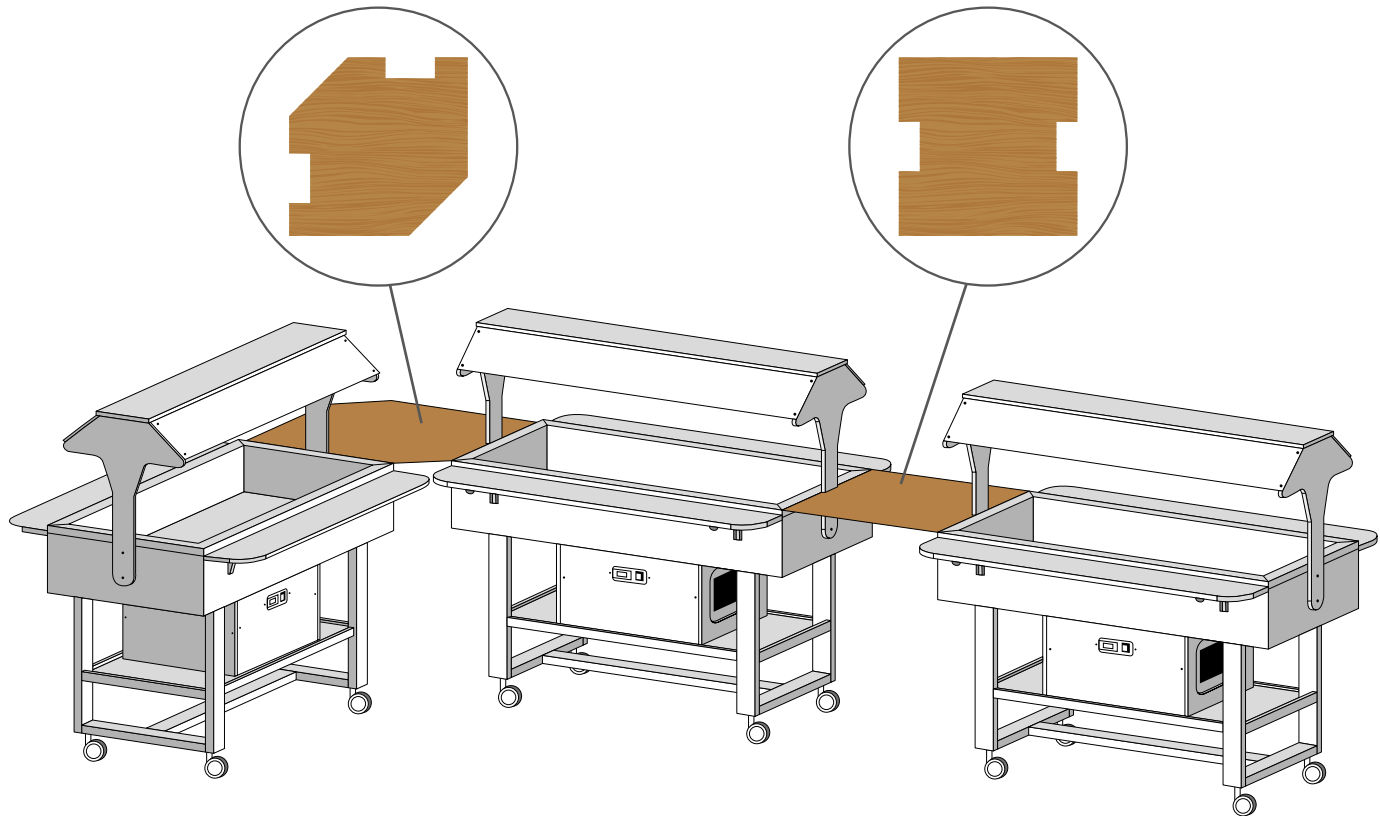
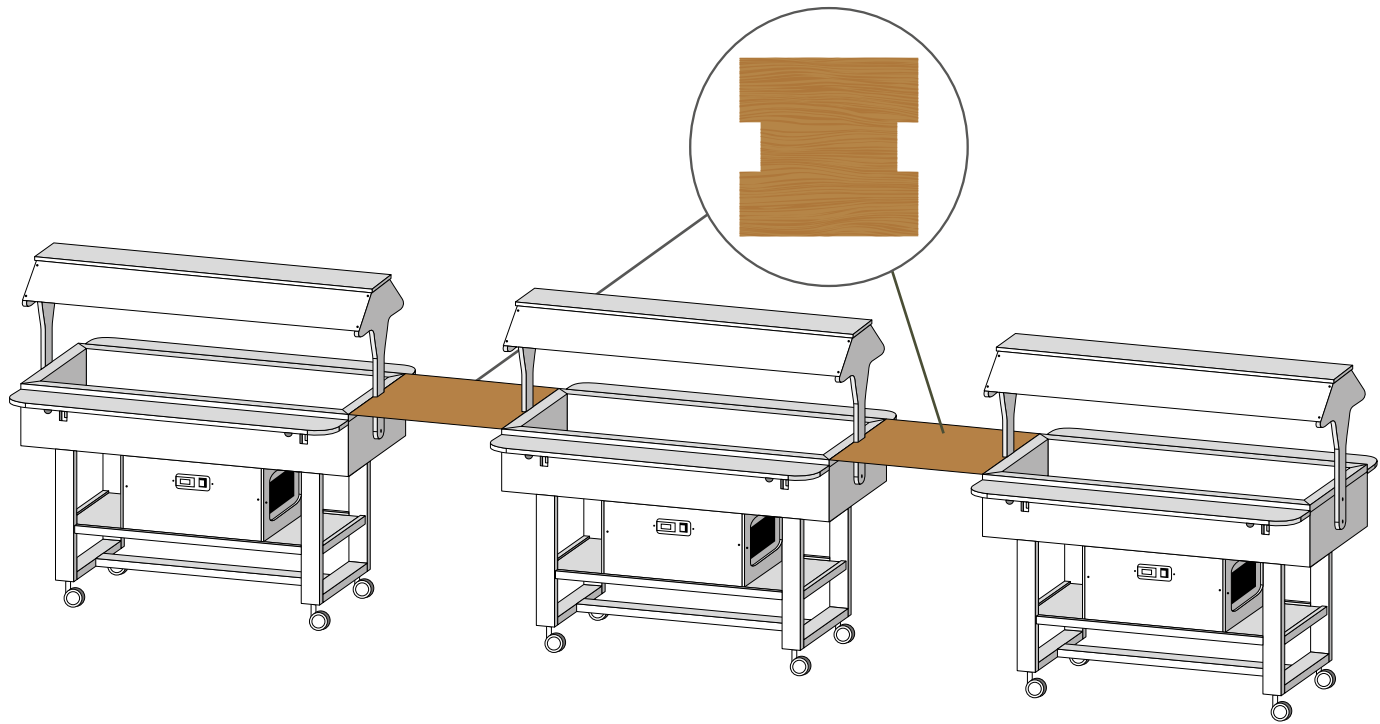



Carrelli, vasche e distributori in acciaio inox

STAINLESS STEEL TROLLEYS,
BOWLS AND DISPENSERS.
CHARIOTS, CUVES ET DISTRIBUTEURS
EN ACIER INOX
WAGEN, WANNEN UND SPENDER
AUS EDELSTAHL

G-VRI211 - G-VRI311 G-VRI411 - G-VRI311F G-VRI411F



G-VRI



IT Vasche refrigerate da incasso in acciaio inox **AISI 304**. Struttura in acciaio inox **AISI 304** - spessore isolamenti 50 mm - refrigerazione statica - gruppo incorporato nel vano inferiore - controllo temperatura elettronico con termostato digitale - sbrinamento automatico - evaporazione dell'acqua di condensa automatica.

EN Stainless steel **AISI 304** refrigerated bowls. Stainless steel **AISI 304** structure - 50 mm insulation thickness - static refrigeration - built-in control unit in the lower compartment - electronic temperature control with digital thermostat - automatic defrosting - automatic evaporation of condensation water.

FR Cuves réfrigérées en acier inox **AISI 304**. Structure en acier inox **AISI 304** - épaisseur d'isolation de 50 mm - réfrigération statique - unité incorporée dans le compartiment inférieur - régulation électronique de température avec thermostat digital - dégivrage automatique - évaporation automatique de l'eau de condensation.

DE Kühlwannen aus Edelstahl **AISI 304**. Struktur aus Edelstahl **AISI 304** - 50 mm Isolierstärke - statische Kühlung - Einbaueinheit im unteren Fach - elektronische Temperaturregelung mit digitalem Thermostat - automatische Abtauung - automatische Kondensatverdampfung.

i	G-VRI211	G-VRI311	G-VRI411	G-VRI311F	G-VRI411F
⚡	340 W				
1 Ph	220/240V 50HZ				
🌡️	+2°C +8°C			-5°C +5°C	
N.	2 x GN1/1 - 150(h) mm	3 x GN1/1 - 150(h) mm	4 x GN1/1 - 150(h) mm	3 x GN1/1 - 150(h) mm	4 x GN1/1 - 150(h) mm
	1.565 €	1.675 €	1.780 €	2.090 €	2.280 €

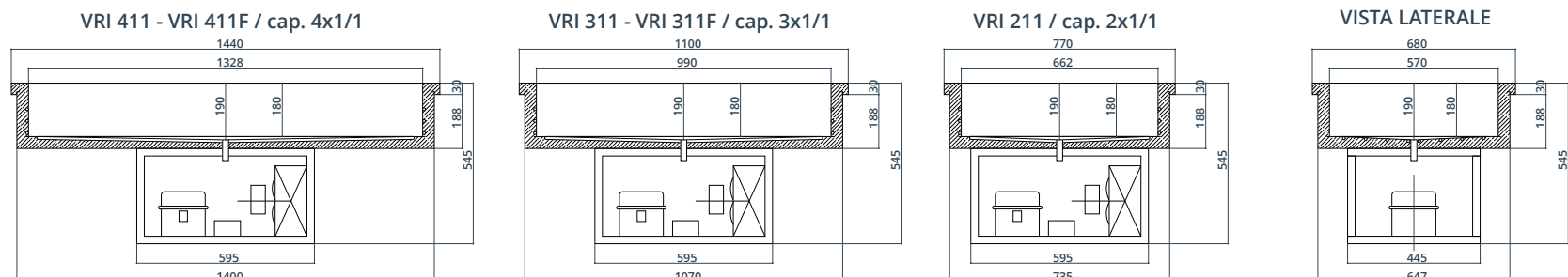

Vasche refrigerate in acciaio inox AISI 304 ad incasso
Recessed stainless steel AISI 304 refrigerated bowls

VBC 211 - VBC 311 VBC 411







IT Vasche termiche da incasso a bagnomaria in acciaio inox **AISI 304**. Vasca dotata di scarico acqua - controllo temperatura elettronico con termostato digitale.

EN Stainless steel **AISI 304** heated Bain-marie bowls. Bowl with water drain - electronic temperature control with digital thermostat.

FR Cuves bain-marie en acier inox **AISI 304**. Cuve équipée de vidange d'eau - régulation électronique de la température avec thermostat digital.

DE Bain-Marie Heizwannen aus Edelstahl **AISI 304**. Wanne mit Wasserablauf - elektronische Temperaturregelung mit digitalem Thermostat.

	VBC 211	VBC 311	VBC 411
	2000 W		
 1 Ph	220/240V 50HZ		
	+30°C +90°C		
	2 x GN1/1 - 150(h) mm	3 x GN1/1 - 150(h) mm	4 x GN1/1 - 150(h) mm
	730 €	810 €	910 €

VBC

CLR311	CF411
GRIGLIA FORATA 3x1/1 S/S PERFORATED CONTAINER 3x1/1 GN	VASCA INOX FORATA 4x1/1GN S/S PERFORATED CONTAINER
160 €	180 €

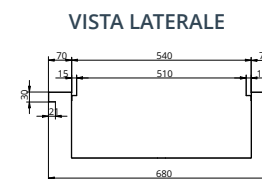
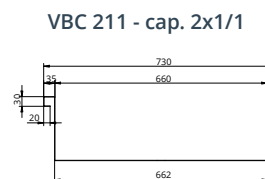
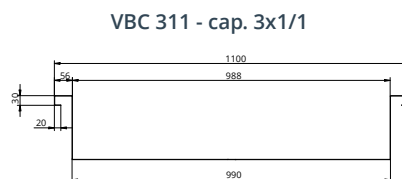
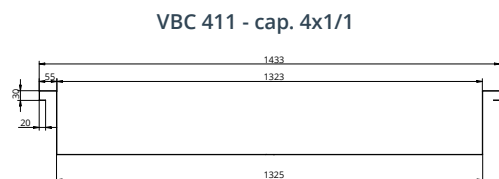

CAR 2779









IT Carrello refrigerato in acciaio inox. Struttura in acciaio inox **AISI 304** - refrigerazione statica - maniglia direzionale - ruote multidirezionali \varnothing 125 mm. Bacinelle escluse - le temperature di lavoro indicate sono da considerarsi con coperchi posizionati.

EN Stainless steel refrigerated trolley. Stainless steel **AISI 304** structure - static refrigeration - directional handle - multidirectional wheels \varnothing 125 mm. Containers not included - the operating temperatures listed are to be considered with lids on.

FR Chariot réfrigéré en acier inox. Structure en acier inox **AISI 304** - réfrigération statique - poignée directionnelle - roues multidirectionnelles \varnothing 125 mm. Bacs non compris - les températures de travail indiquées sont à considérer avec couvercles en place.







DE Kühlwagen aus Edelstahl. Struktur Edelstahl AISI 304 - statische Kühlung - Lenkgriff - Mehrwegräder \varnothing 125 mm. Behälter nicht enthalten - die angegebenen Arbeitstemperaturen sind bei aufgesetzten Deckeln zu verstehen.

	CAR 2779	
	250 W	
	230V/1N/ 50HZ	
	R600a	
	+2°C +10°C	
	3 x GN1/1 - 150(h) mm	
	124 x 72 x 94(h) cm	
	2.780 €	

CAR 2780 - CAR 2780BT



CAR 2780

	CAR 2780	CAR 2780BT
	250 W	
	230V/1N/ 50HZ	
	R600a	
	+2°C +10°C	-5°C +5°C
	3 x GN1/1 - 150(h) mm	
	124 x 72 x 126(h) cm	
	3.160 €	3.470 €

Carrelli refrigerati in acciaio inox AISI 304
Stainless steel AISI 304 refrigerated trolleys

CT 1760C









CT 1760C
CON CUPOLA SEMICIRCOLARE / WITH SEMICIRCULAR DOME

IT Carrelli termici a bagnomaria. Struttura in acciaio inox **AISI 304** - vasca a doppia parete provvista di rubinetto di scarico posto sul fondo - termostato regolabile - maniglia direzionale - paracolpi - ruote multidirezionali ø 125 mm. Bacinelle escluse - le temperature di lavoro indicate sono da considerarsi con coperchi posizionati.

EN Bain-marie heated trolleys. Stainless steel **AISI 304** structure - double walled bowl with drain valve fitted at the bottom - adjustable thermostat - directional handle - shock absorber - multidirectional wheels ø 125 mm. Containers not included - the operating temperatures listed are to be considered with lids on.

FR Chariots chauffantes bain-marie. Structure en acier inox **AISI 304** - cuve à double paroi équipée d'un robinet de vidange en bas - thermostat réglable - poignée directionnelle - butoirs - roues multidirectionnelles ø 125 mm. Bacs non compris - les températures de travail indiquées sont à considérer avec couvercles en place.

DE Bain-Marie Heizwagen Struktur aus Edelstahl **AISI 304** - Doppelwandige Wanne mit einem Abfließhahn im Unterteil - einstellbarer Thermostat - Lenkergriff - Stoßschutz - Mehrwegräder ø 125 mm. Behälter nicht enthalten - die angegebenen Arbeitstemperaturen sind bei aufgesetzten Deckeln zu verstehen.

	CT 1760C
	2000 W
 1 Ph	230V/ 50-60 HZ
	+30° +90°C
 N.	3 x GN1/1 - 200(h) mm
	117 x 67 x 114(h) cm
	1.625 €

CT 1758TD - CT 1760TD









CT 1760TD

IT Carrelli termici a bagnomaria con temperature differenziate in acciaio inox **AISI 304**. Struttura in acciaio inox **AISI 304** - vasca a doppia parete provvista di rubinetto di scarico posto sul fondo - termostato regolabile - maniglia direzionale - paracolpi - ruote multidirezionali \varnothing 125 mm. Bacinelle escluse - le temperature di lavoro indicate sono da considerarsi con coperchi posizionati.

EN Stainless steel **AISI 304** Bain-marie heated trolleys with separate temperatures. Stainless steel **AISI 304** structure - double walled bowl with drain valve fitted at the bottom - adjustable thermostat - directional handle - shock absorber - multidirectional wheels \varnothing 125 mm. Containers not included - the operating temperatures listed are to be considered with lids on.

FR Chariots chauffantes bain-marie à températures différenciées en acier inox **AISI 304**. Structure en acier inox **AISI 304** - cuve à double paroi équipée d'un robinet de vidange en bas - thermostat réglable - poignée directionnelle - butoirs - roues multidirectionnelles \varnothing 125 mm. Bacs non compris - les températures de travail indiquées sont à considérer avec couvercles en place.

DE Bain-Marie Heizwagen mit unterschiedlichen Temperaturen aus Edelstahl **AISI 304**. Struktur aus Edelstahl **AISI 304** - Doppelwandige Wanne ausgestattet mit einem unten angebrachten Ablaufventil - einstellbarer Thermostat - Lenkergriff - Stoßschutz - Mehrwegräder \varnothing 125 mm. Behälter nicht enthalten - die angegebenen Arbeitstemperaturen sind bei aufgesetzten Deckeln zu verstehen.

	CT 1758TD	CT 1760TD
	2000 W	3000 W
 1 Ph	230V/ 50-60 HZ	
	+30° +90°C	
 N.	2 x GN1/1 - 150(h) mm	3 x GN1/1 - 150(h) mm
 cm	84 x 65 x 85(h) cm	117 x 67 x 85(h) cm
	1.105 €	1.380 €

CT 1765 - CT 1770



CT 1765

IT Carrelli termici a bagnomaria armadiati. Struttura in acciaio inox **AISI 304** - vano superiore in doppia parete coibentata - coperchi apribili a compasso fino a 180° per formare un piano di appoggio - provvisti di rubinetto di scarico posto sul fondo - 2 ruote fisse e 2 multidirezionali ø 140 mm. Bacinelle escluse - le temperature di lavoro indicate sono da considerarsi con coperchi posizionati.

EN Bain-marie heated trolleys on counters. Structure in **AISI 304** stainless steel - insulated double-walled upper compartment - lids that can be opened up to 180° to form a support surface. Equipped with a drain valve on the bottom - 2 fixed wheels and 2 multidirectional wheels ø 140 mm. Containers not included - the operating temperatures listed are to be considered with lids on.

FR Chariots chauffants bain-marie sur meublé fermé. Structure en acier inox **AISI 304** - compartiment supérieur en double paroi isolée - couvercles pouvant s'ouvrir jusqu'à 180° pour former une surface d'appui - 2 roues fixes et 2 roues multidirectionnelles ø 140 mm, équipées d'un robinet de vidange placé en bas. Bacs non compris - les températures de travail indiquées sont à considérer avec couvercles en place.

DE Bain-Marie Heizwagen mit Schrankelement. Struktur aus Edelstahl **AISI 304** - oberes Fach mit isoliertem Doppelwand - Deckel bis zu 180° öffnungsfähig, um eine Auflagefläche zu bilden, ausgestattet mit einem unten angebrachten Ablaufventil - 2 feste Räder und 2 Mehrwegräder ø 140 mm. Behälter nicht enthalten - die angegebenen Arbeitstemperaturen sind bei aufgesetzten Deckeln zu verstehen.



CT 1770

	CT 1765	CT 1770
	2000 W	
	230V/ 50-60 HZ	
	+30° +90°C	
	2 x GN1/1 - 200(h) mm	3 x GN1/1 - 200(h) mm
	96 x 68 x 102(h) cm	130 x 68 x 102(h) cm
	2.680 €	2.965 €

CT 1766 - CT 1771









CT1771

IT Carrelli termici a bagnomaria armadiati. Struttura in acciaio inox **AISI 304** - vano superiore in doppia parete coibentata - provvisti di rubinetto di scarico posto sul fondo - 2 ruote fisse e 2 multidirezionali ø 140 mm. Bacinelle escluse.

EN Bain-marie heated trolleys on counters. Structure in **AISI 304** stainless steel - insulated double-walled upper compartment - equipped with a drain valve on the bottom - 2 fixed wheels and 2 multidirectional wheels ø 140 mm. Containers not included.

FR Chariots chauffantes bain-marie sur meublé fermé. Structure en acier inox **AISI 304** - compartiment supérieur en double paroi isolée - 2 roues fixes et 2 roues multidirectionnelles ø 140 mm, équipées d'un robinet de vidange placé en bas. Bacs non compris.

DE Bain-Marie Heizwagen mit Schrankelement. Struktur aus Edelstahl **AISI 304** - oberes Fach mit isoliertem Doppelwand - ausgestattet mit einem unten angebrachten Ablaufventil - 2 feste Räder und 2 Mehrwegräder ø 140 mm. Behälter nicht enthalten.

	CT 1766	CT 1771
	2000 W	
 1 Ph	230V/ 50-60 HZ	
	+30° +90°C	
	2 x GN1/1 - 200(h) mm	3 x GN1/1 - 200(h) mm
	96 x 68 x 92(h) cm	130 x 68 x 92(h) cm
	2.135 €	2.425 €

CT 1765TD - CT 1770TD



CT 1765TD









IT Carrelli termici a bagnomaria armadiati con temperatura differenziata. Struttura in acciaio inox **AISI 304** - vano superiore in doppia parete coibentata - coperchi apribili a compasso fino a 180° per formare un piano di appoggio - provvisti di rubinetto di scarico posto sul fondo - 2 ruote fisse e 2 multidirezionali ø 140 mm. Bacinelle escluse - le temperature di lavoro indicate sono da considerarsi con coperchi posizionati.

EN Bain-marie heated trolleys on counters with differentiated temperature. Structure in **AISI 304** stainless steel - insulated double-walled upper compartment - lids that can be opened up to 180° to form a support surface. Equipped with a drain valve on the bottom - 2 fixed wheels and 2 multidirectional wheels ø 140 mm. Containers not included - the operating temperatures listed are to be considered with lids on.

FR Chariots bain-marie chauffés à température différenciée. Structure en acier inox **AISI 304** - compartiment supérieur en double paroi isolée - couvercles pouvant s'ouvrir jusqu'à 180° pour former une surface d'appui - 2 roues fixes et 2 roues multidirectionnelles ø 140 mm, équipées d'un robinet de vidange placé en bas. Bacs non compris - les températures de travail indiquées sont à considérer avec couvercles en place.

DE Bain-Marie Heizwagen mit Schrankelement mit unterschiedlichen Temperaturen. Struktur aus Edelstahl **AISI 304** - oberes Fach in isolierter Doppelwand - Deckel bis zu 180° öffnungsfähig, um eine Auflagefläche zu bilden, ausgestattet mit einem unten angebrachten Ablaufventil - 2 feste Räder und 2 Mehrwegräder ø 140 mm. Behälter nicht enthalten - die angegebenen Arbeitstemperaturen sind bei aufgesetzten Deckeln zu verstehen.

	CT 1765TD	CT 1770TD
		
	2000 W	3000 W
	230V/ 50-60 HZ	
	+30° +90°C	
	2 x GN1/1 - 150(h) mm	3 x GN1/1 - 150(h) mm
	96 x 68 x 102(h) cm	130 x 68 x 102(h) cm
	2.850 €	3.310 €

CT 1766TD - CT 1771TD









CT 1771TD

IT Carrelli termici a bagnomaria armadiati con temperatura differenziata. Struttura in acciaio inox **AISI 304** - vano superiore in doppia parete coibentata - provvisti di rubinetto di scarico posto sul fondo - 2 ruote fisse e 2 multidirezionali ø 140 mm. Bacinelle escluse.

EN Bain-marie heated trolleys on counters with differentiated temperature. Structure in **AISI 304** stainless steel - insulated double-walled upper compartment - Equipped with a drain valve on the bottom - 2 fixed wheels and 2 multidirectional wheels ø 140 mm. Containers not included.

FR Bain-marie heated trolleys on counters with differentiated temperature. Structure in **AISI 304** stainless steel - insulated double-walled upper compartment - équipée d'un robinet de vidange en bas - 2 roues fixes et 2 roues multidirectionnelles ø 140 mm. Bacs non compris.

DE Bain-Marie Heizwagen mit Schrankelement mit unterschiedlichen Temperaturen. Struktur aus Edelstahl **AISI 304** - oberes Fach in isolierter Doppelwand - ausgestattet mit einem unten angebrachten Ablaufventil - 2 feste Räder und 2 Mehrwegräder ø 140 mm. Behälter nicht enthalten.

	CT 1766TD	CT 1771TD
	2000 W	3000 W
 1 Ph	230V/ 50-60 HZ	
	+30° +90°C	
 N.	2 x GN1/1 - 150(h) mm	3 x GN1/1 - 150(h) mm
 cm	96 x 68 x 92(h) cm	130 x 68 x 92(h) cm
	2.365 €	2.770 €

CS 1751 - CS 1753 CS 1755



CS 1751

**FUORI PRODUZIONE
OUT OF PRODUCTION**

IT Carrelli termici scalda tegamini/biberon. Struttura in acciaio inox **AISI 304** - vasca a doppia parete provvista di rubinetto di scarico posto sul fondo - termostato regolabile - maniglia direzionale - ruote multidirezionali Ø 125 mm. Le temperature di lavoro indicate sono da considerarsi con coperchi posizionati.

EN Heated trolleys for small pans and baby bottles heating. Stainless steel **AISI 304** structure - double walled bowl with drain valve fitted at the bottom - adjustable thermostat - directional handle - multidirectional wheels Ø 125 mm. The operating temperatures listed are to be considered with lids on.

FR Chariots chauffants pour réchauffer petit récipients ou biberon. Structure en acier inox **AISI 304** - cuve à double paroi équipée d'un robinet de vidange en bas - thermostat réglable - poignée directionnelle - roues multidirectionnelles Ø 125 mm. Les températures de travail indiquées sont à considérer avec couvercles en place.

DE Heizwagen für Pfannen- und Babyflaschenerwärmung. Struktur aus Edelstahl **AISI 304** - Doppelwandige Wanne ausgestattet mit einem unten angebrachten Ablaufventil - einstellbarer Thermostat - Lenkergriff - Mehrwegräder Ø 125 mm. Die angegebenen Arbeitstemperaturen sind bei aufgesetzten Deckeln zu verstehen.

	A BAGNOMARIA / BAIN MARIE		
i	CS 1751	CS 1753	CS 1755
⚡	2000 W		
🔌 1 Ph	230V/ 50-60 HZ		
🌡️	+30° +90°C		
📏 cm	30 x 50 cm	51 x 62 cm	51 x 96 cm
📏 cm	56 x 65 x 85(h) cm	84 x 65 x 85(h) cm	117 x 65 x 85(h) cm
	-	-	-

CT 1756 - CTS 1757
 CT 1758 - CTS 1759
 CT 1760 - CTS 1761
 CT 1762









CT 1760

IT Carrelli termici. Struttura in acciaio inox **AISI 304** - vasca a doppia parete - termostato regolabile - maniglia direzionale - ruote multidirezionali Ø 125 mm. Bacinelle escluse - le temperature di lavoro indicate sono da considerarsi con coperchi posizionati.

EN Heated trolleys. Stainless steel **AISI 304** structure - double walled bowl - adjustable thermostat - directional handle - multidirectional wheels Ø 125 mm. Containers not included - the operating temperatures listed are to be considered with lids on.

FR Chariots chauffants. Structure en acier inox **AISI 304** - cuve à double paroi - thermostat réglable - poignée directionnelle - roues multidirectionnelles Ø 125 mm. Bacs non compris - les températures de travail indiquées sont à considérer avec couvercles en place.

DE Heizwagen. Struktur aus Edelstahl **AISI 304** - Doppelwandige Wanne - einstellbarer Thermostat - Lenkergriff - Mehrwegräder Ø 125 mm. Behälter nicht enthalten - die angegebenen Arbeitstemperaturen sind bei aufgesetzten Deckeln zu verstehen.

	A BAGNOMARIA / BAIN MARIE				CON RESISTENZA A SECCO / WITH DRY HEATING ELEMENT		
	CT 1756	CT 1758	CT 1760	CT 1762	CTS 1757	CTS 1759	CTS 1761
	2000 W				1000 W	2000 W	
 1 Ph	230V/ 50-60 HZ						
	+30° +90°C						
	1 x GN1/1 - 200(h) mm	2 x GN1/1 - 200(h) mm	3 x GN1/1 - 200(h) mm	4 x GN1/1 - 200(h) mm	1 x GN1/1 - 200(h) mm	2 x GN1/1 - 200(h) mm	3 x GN1/1 - 200(h) mm
	56 x 65 x 85(h) cm	84 x 65 x 85(h) cm	117 x 65 x 85(h) cm	148 x 65 x 85(h) cm	56 x 65 x 85(h) cm	84 x 65 x 85(h) cm	117 x 65 x 85(h) cm
	950 €	1.070 €	1.180 €	1.385 €	850 €	1.000 €	1.235 €

Carrelli termici in acciaio inox AISI 304
 Stainless steel AISI 304 heated trolley

DC 1704 - DC 1703

DCM 1699
DCM 1701



DCM 1699

**FUORI PRODUZIONE
OUT OF PRODUCTION**







DC 1703





IT Distributori per prime colazioni. Struttura interamente in acciaio inox **AISI 304** 18/10 - vasca doppia parete - recipienti in acciaio inox **AISI 304** 18/10 da L 15 cad. complete di coperchio - rubinetti in plastica facilmente rimovibili - termostato regolabile - disponibili nella versione con mobiletto di sostegno in acciaio inox **AISI 304** con anta battente - ripiano intermedio - ruote multidirezionali da \varnothing 95 mm, oppure nella versione da appoggio.

EN Breakfast dispensers. Structure entirely in stainless steel **AISI 304** 18/10 - double-walled bowl - containers in stainless steel **AISI 304** 18/10 of 15 L each, with lid - easily removable plastic taps - adjustable thermostat - available in the version with support unit in stainless steel **AISI 304** with hinged door - intermediate shelf - \varnothing 95 mm multidirectional wheels, or in the countertop version.

FR Distributeurs pour le petit déjeuner. Structure entièrement en acier inox **AISI 304** 18/10 - cuve à double paroi - cuves en acier inox **AISI 304** 18/10 de 15 L chacune avec couvercle - robinets en plastique facilement démontables - thermostat réglable - disponible dans la version avec armoire en acier inox **AISI 304** avec porte battante - étagère intermédiaire - roues multidirectionnelles \varnothing 95 mm ou en version de table.

DE Frühstücksspender. Gehäuse vollständig aus Edelstahl **AISI 304** 18/10 - doppelwandige Wanne - Behälter aus Edelstahl **AISI 304** 18/10 je 15 L mit Deckel - leicht abnehmbare Kunststoffhähne - einstellbarer Thermostat - erhältlich in der Ausführung mit Stützschränk aus Edelstahl **AISI 304** mit Flügeltür - Zwischenboden - \varnothing 95 mm Mehrwegräder, oder als Tisch Version.

	DCM 1699	DCM 1701
	2000 W	
	230V/ 50-60 HZ	
	+30° +90°C	
	2 recipienti da 15 L 2 tanks 15 L	3 recipienti da 15 L 3 tanks 15 L
	75 x 41 x 135(h) cm	106 x 41 x 135(h) cm

	DC 1704	DC 1703
	2000 W	
	230V/ 50-60 HZ	
	+30° +90°C	
	2 recipienti da 15 L 2 tanks 15 L	3 recipienti da 15 L 3 tanks 15 L
	75 x 41 x 71(h) cm	106 x 41 x 71(h) cm

Carrelli termici Heated Trolleys

	A700
Mod.	CT1770 - CT1771 - CT1770TD - CT1771TD
	Vano inferiore riscaldato Heated lower compartment Compartment inferieur chauffé Beheiztes Unterfach
	215 €

	A650
Mod.	CT1765 - CT1766 - CT1766TD - CT1765TD
	Vano inferiore riscaldato Heated lower compartment Compartment inferieur chauffé Beheiztes Unterfach
	215 €



Optional



Elementi riscaldanti e vetrine neutre

HEATING ELEMENTS
AND NEUTRAL DISPLAYS
ÉLÉMENTS CHAUFFANTS
ET VITRINES NEUTRES
HEIZELEMENTE
UND NEUTRALE VITRINEN

BM 1780 - BM 1782 BM 1784 - BM 1786









BM 1874

IT Tavole calde a bagnomaria. Struttura in acciaio inox **AISI 304** - parete coibentata - rubinetto di scarico - termostato regolabile. Le bacinelle sono escluse.

EN Bain-marie heated tables. Stainless steel **AISI 304** structure - insulated wall - drain valve - adjustable thermostat. Containers not included.

FR Tables chaudes avec bain-marie. Structure en acier inox **AISI 304** - paroi isolée - robinet de vidange - thermostat réglable. Les bacs ne sont pas compris.

DE Bain-Marie Heitzische. Struktur aus Edelstahl **AISI 304** - isolierte Wand - Ablaufventil - einstellbarer Thermostat. Behälter nicht enthalten.

	BM 1780	BM 1782	BM 1784	BM 1786
	2000 W			
	230V/ 50-60 HZ			
	+30° +90°C			
	1 x GN1/1 200(h) mm	2 x GN1/1 200(h) mm	3 x GN1/1 200(h) mm	4 x GN1/1 200(h) mm
	49 x 60 x 32(h) cm	78 x 60 x 32(h) cm	110 x 60 x 32(h) cm	144 x 60 x 32(h) cm
	770 €	905 €	980 €	1.120 €

BMS 1781 - BMS 1783 BMS 1785









BMS 1785

IT Tavole calde con resistenza a secco (senza acqua). Struttura in acciaio inox **AISI 304** - parete coibentata - termostato regolabile. Le bacinelle sono escluse.

EN Heated tables with dry heating element (without water). Stainless steel **AISI 304** structure - insulated wall - adjustable thermostat. Containers not included.

FR Heated tables with dry heating element (without water). Stainless steel **AISI 304** structure - insulated wall - adjustable thermostat. Containers not included.

DE Heitzische mit Trockenheizstab (ohne Wasser). Struktur aus Edelstahl **AISI 304** - isolierte Wand - einstellbarer Thermostat. Behälter nicht enthalten.

	BMS 1781	BMS 1783	BMS 1785
	1000 W		
	230V/ 50-60 HZ		
	+30° +90°C		
	1 x GN1/1 - 200(h) mm	2 x GN1/1 - 200(h) mm	3 x GN1/1 - 200(h) mm
	49 x 60 x 32(h) cm	78 x 60 x 32(h) cm	110 x 60 x 32(h) cm
	620 €	795 €	985 €

Tavole calde
Heated tables

BM 11 - BM 21 - BM 31



BM 11

IT Tavole calde a bagnomaria. Struttura in acciaio inox - termostato regolabile. Le bacinelle sono escluse.

EN Bain-marie heated tables. Stainless steel structure - adjustable thermostat. Containers not included.

FR Tables chaudes avec bain-marie . Structure en acier inox - thermostat réglable. Les bacs ne sont pas compris.

DE Bain-Marie Heiztische. Edelstahlstruktur - einstellbarer Thermostat. Behälter nicht enthalten.

BMV 11 - BMV 21 BMV 31









BMV 21

IT Tavole calde a bagnomaria. Struttura in acciaio inox - rubinetto di scarico - temperature vasche differenziate - termostato regolabile. Le bacinelle sono escluse.

EN Bain-marie heated tables. Stainless steel structure - drain valve - differentiated bowl temperatures - adjustable thermostat. Containers not included.

FR Tables chaudes avec bain-marie . Structure en acier inox - robinet de vidange - différentes températures des cuves - thermostat réglable. Les bacs ne sont pas compris.

DE Bain-Marie Heiztische. Edelstahlstruktur - Ablaufventil - unterschiedliche Temperaturen - einstellbarer Thermostat. Behälter nicht enthalten.

	BM 11	BM 21	BM 31
	1200 W	1200 + 1200 W	1000 + 1000 +1000 W
	230V/50-60 HZ		
	+30° +90°C		
	1 x GN1/1 - 150(h) mm	2 x GN1/1 - 150(h) mm	3 x GN1/1 - 150(h) mm
	54 x 33 x 22(h) cm	66 x 54 x 22(h) cm	99 x 54 x 22(h) cm
	390 €	570 €	760 €

	BMV 11	BMV 21	BMV 31
	1200 W	1200 + 1200 W	1000 + 1000 +1000 W
	230V/50-60 HZ		
	+30° +90°C		
	1 x GN1/1 - 150(h) mm	2 x GN1/1 - 150(h) mm	3 x GN1/1 - 150(h)mm
	54 x 33 x 22(h) cm	66 x 54 x 22(h) cm	99 x 54 x 22(h) cm
	435 €	650 €	885 €

BM 7700



BMP 7720



IT Tavola calda a bagnomaria. Struttura in acciaio inox - bacinella esclusa

EN Bain-marie heated table. Stainless steel structure - containers not included

FR Table chaude avec bain-marie . Structure en acier inox - bacs pas compris.







DE Bain-Marie Heiztisch. Edelstahlstruktur - Behälter nicht enthalten





IT Tavola calda a bagnomaria. Struttura in acciaio inox - modello compreso di 2 pentole da 8 L.

EN Bain-marie heated table. Stainless steel structure - with 2 pans of 8 L.

FR Table chaude avec bain-marie . Structure en acier inox - modèle équipé de 2 marmites de 8 L.

DE Bain-Marie Heiztisch. Struktur aus Edelstahl - Modell mit 2 Kesseln 8 L je.

	BM 7700
	1200 W
	230V/ 50-60 HZ
	+30° +90°C
	1 x GN1/1 - 150(h) mm
	57 x 37 x 22(h) cm
	200 €

	BMP 7720
	1200 W
	230V/ 50-60 HZ
	+30° +90°C
	2 pentole 2 pots
	57 x 37 x 28(h) cm
	290 €

Tavole calde
Heated tables

PC 4750 - PC 4752
 PC 4754 - PC 5050
 PC 6040 - PC 8060

PC 4754



- IT Piani caldi in acciaio inox. Struttura in acciaio inox **AISI 304** - termostato regolabile
- EN Hot plates in stainless steel. Stainless steel **AISI 304** structure - adjustable thermostat.
- FR Hot plates in stainless steel. Stainless steel **AISI 304** structure - adjustable thermostat.
- DE Heiße Edelstahlplatten. Struktur aus Edelstahl **AISI 304** - einstellbarer Thermostat.

PVC 4760 - PVC 4763
 PVC 4765

PVC 4760



- IT Piani caldi con piano in vetro temperato. Struttura in acciaio inox **AISI 304** - termostato regolabile.
- EN Hot plates with tempered glass top. Stainless steel **AISI 304** structure - adjustable thermostat.
- FR Plaques chauffantes avec plan en verre trempé. Structure en acier inox **AISI 304** - thermostat réglable.
- DE Heiße Platten mit gehärteter Glasoberfläche. Struktur aus Edelstahl **AISI 304** - einstellbarer Thermostat.

	PC 4750	PC 4752	PC 4754
	250 W	450 W	600 W
	230V/ 50-60 HZ		
	+30° +90°C		
	50 x 35 x 6(h) cm	90 x 45 x 6(h) cm	100 x 50 x 6(h) cm
	200 €	270 €	325 €

	PVC 4760	PVC 4763	PVC4765
	600 W		1000 W
	230V/50-60 HZ		
	+30° +90°C		
	50 x 50 x 7(h) cm	60 x 40 x 7(h) cm	81 x 61 x 7(h) cm
	400 €	385 €	470 €

	PC 5050	PC 6040	PC 8060
	600 W		1000 W
	230V/50-60 HZ		
	+30° +90°C		
	50 x 50 x 6(h) cm	60 x 40 x 6(h) cm	80 x 60 x 6(h) cm
	260 €	270 €	405 €

PCC 4710 - PCC 4730



PCC 4710





PCC 4730

IT Piani caldi con cupola in plexiglass. Struttura in acciaio inox **AISI 304** - termostato regolabile

EN Hot plates with Plexiglas dome. Stainless steel **AISI 304** structure - adjustable thermostat.

FR Plaques chauffantes avec clochette en plexiglas. Structure en acier inox **AISI 304** - thermostat réglable.

DE Heiße Platten mit Plexiglashaube. Struktur aus Edelstahl **AISI 304** - einstellbarer Thermostat

	PCC 4710	PCC 4730
	450 W	600 W
 1 Ph	230V/ 50-60 HZ	230V/ 50-60 HZ
	+30° +90°C	
	90 x 45 x 20(h) cm	100 x 50 x 30(h) cm
	540 €	610 €

Piani caldi
Hot plates

PCI 4711 - PCI 4712 PCI 4713







PCI 4713

IT Lampade a infrarossi con piano caldo in acciaio inox. Struttura in acciaio inox - termostato regolabile - copertura in policarbonato fumè.

EN Infrared lamps with stainless steel heated plate. Stainless steel structure - adjustable thermostat - smoky grey polycarbonate lid.

FR Lampes infrarouges avec plaque chaude en acier inox. Structure en acier inox - thermostat réglable - couvercle en polycarbonate fumé.

DE Infrarot-Lampen mit Edelstahlwärmplatte. Struktur aus Edelstahl **AISI 304** - einstellbarer Thermostat - dunkle Polycarbonatabdeckung.

	PCI 4711	PCI 4712	PCI 4713
	250 +250 W	450 +500 W	600 +750 W
 1 Ph	230V/ 50-60 HZ		
	+30° +90°C		
	1 lampada 1 lamp	2 lampade 2 lamps	3 lampade 3 lamps
	45 x 64 x 80(h) cm	85 x 64 x 80(h) cm	127 x 68 x 80(h) cm
	490 €	740 €	950 €

Lampade a raggi infrarossi
Infrared lamps

PI 4714 - PI 4715 PI 4716

PIA 4714 - PIA 4715 PIA 4716



PI4716



PIA 4716



PI4715



PIA 4715

IT Telaio con lampade a infrarossi.

IT Telaio con lampade a infrarossi da appendere.

EN Frame with infrared lamps.





EN Frame with hanging infrared lamps.





FR Corps avec lampes infrarouges.

FR Corps avec lampes infrarouges suspendues.

DE Rahmen mit Infrarotlampen.

DE Rahmen mit hängenden Infrarotlampen.

	PI 4714	PI 4715	PI 4716
	250 W	500 W	750 W
 1 Ph	230V/ 50-60 HZ		
	+30° +90°C		
	1 lampada 1 lamp	2 lampade 2 lamps	3 lampade 3 lamps
	45 x 55 x 70(h) cm	85 x 55 x 70(h) cm	127 x 55 x 70(h) cm
	312 €	470 €	600 €

	PIA 4714	PIA 4715	PIA 4716
	250 W	500 W	750 W
 1 Ph	230V/ 50-60 HZ		
	+30° +90°C		
	1 lampada 1 lamp	2 lampade 2 lamps	3 lampade 3 lamps
	45 x 68 x 25(h) cm	85 x 68 x 25(h) cm	128 x 68 x 25(h) cm
	245 €	390 €	500 €

PCI 4717 - PCI 4718 PCI 4718D



PCI 4717

PCI 4718





PCI 4718D

IT Lampade a infrarossi con piano caldo in acciaio inox, in diversi modelli. Struttura in acciaio inox e termostato regolabile.

EN Infrared lamps with stainless steel hot plate, in different models. Stainless steel structure and adjustable thermostat.

FR Lampes infrarouges avec plaque chauffante en acier inox, en différents modèles. Structure en acier inox et thermostat réglable.

DE Infrarotlampen mit Heizplatte aus Edelstahl, in verschiedenen Ausführungen. Edelstahlstruktur und einstellbarer Thermostat.

	PCI 4717	PCI 4718	PCI 4718D
	250 + 250 + 250 W	250 + 250 W	250 + 250 + 250 W
 1 Ph	230V/ 50-60 HZ		
	+30° +90°C		
	2 lampade 2 lamps	1 lampada 1 lamp	2 lampade 2 lamps
 cm	60 x 40 x 68(h) cm	58 x 33 x 68(h) cm	
	600 €	455 €	580 €

BI 4719 - BI 4719D



BI 4719

BI 4719D

IT Lampade a infrarossi con contenitore Gastronorm GN1/1. Struttura in acciaio inox.

EN Infrared lamps with Gastronorm GN1/1 container. Stainless steel structure





FR Lampes infrarouges avec récipient Gastronorm GN1/1. Structure en acier inox.

DE Infrarotlampen mit Gastronorm-Behälter GN1/1. Edelstahlstruktur

**OPTIONAL
A516**

Vasca riscaldata
Heated bowl
Cuve chauffée
Beheizte Wanne

105 €

	BI 4719	BI 4719D
	250 W	
 1 Ph	230V/ 50-60 HZ	
	+30° +90°C	
	1 lampada 1 lamp	2 lampade 2 lamps
 cm	60 x 33 x 68(h) cm	
	515 €	535 €

Lampade a raggi infrarossi
Infrared lamps

VBR 4751 - VBR 4752 - VBR 4753 VBR 4781 - VBR 4782 - VBR 4783



VBR 4751



VBR 4752



VBR 4753

IT Vettrine riscaldate. Struttura in acciaio inox **AISI 304** - fianchi e antine sui due fronti in plexiglass trasparente - termostato regolabile - dispositivo di umidificazione.

EN Heated display cases. Structure in stainless steel **AISI 304** - Plexiglas sides and doors on both sides - adjustable thermostat - humidification device.

FR Vitrines chauffées. Structure en acier inox **AISI 304** - côtés et portes des deux côtés en plexiglass transparent - thermostat réglable - dispositif d'humidification.

DE Beheizte Vitrinen. Struktur aus Edelstahl **AISI 304** - Seiten und Türen auf beiden Seiten aus transparentem Plexiglas - einstellbarer Thermostat - Befeuchtungsvorrichtung.

OPTIONAL
PRI50 - 250 W
VBR4751 - VBR4752 - VBR4753 - VBR4756







Piano intermedio riscaldato
Heated intermediate shelf
Étagère intermédiaire chauffée
Beheiztes Zwischenfach

185 €

OPTIONAL
PRI85 - 400 W
VBR4781 - VBR4782 - VBR4783 - VBR4786

Piano intermedio riscaldato
Heated intermediate shelf
Étagère intermédiaire chauffée
Beheiztes Zwischenfach

230 €

	VBR 4751	VBR 4781	VBR 4752	VBR 4782	VBR 4753	VBR 4783
	250 W	400 W	250 W	400 W	400 W	
	230V/ 50-60 HZ					
	+30° +90°C					
	1		2		3	
	50 x 35 x 25(h) cm	85 x 35 x 25(h) cm	50 x 35 x 40(h) cm	85 x 35 x 40(h) cm	50 x 35 x 54(h) cm	85 x 35 x 54(h) cm
	420 €	500 €	565 €	680 €	690 €	840 €



Vetrine riscaldanti
Heated display cases

forcar®

VBR 4756 - VBR 4786





VBR 4786

IT Vetrine riscaldate. Struttura in acciaio inox **AISI 304** - fianchi e antine sui due fronti in plexiglass trasparente - termostato regolabile - dispositivo di umidificazione.

EN Heated display cases. Structure in stainless steel **AISI 304** - Plexiglas sides and doors on both sides - adjustable thermostat - humidification device.

FR Vitrines chauffées. Structure en acier inox **AISI 304** - côtés et portes des deux côtés en plexiglass transparent - thermostat réglable - dispositif d'humidification.

DE Beheizte Vitrinen. Struktur aus Edelstahl **AISI 304** - Seiten und Türen auf beiden Seiten aus transparentem Plexiglas - einstellbarer Thermostat - Befeuchtungsvorrichtung.

	VBR 4756	VBR 4786
	250 W	400 W
 1 Ph	230V/ 50-60 HZ	
	+30° +90°C	
 N.	2	
	50 x 35 x 40(h) cm	85 x 35 x 40(h) cm
	570 €	690 €

Vetrine riscaldanti
Heated display cases

VBN 4756 - VBN 4786



VBN 4756

IT Vetrine neutre. Struttura in acciaio inox **AISI 304** - fianchi e antine sui due fronti in plexiglass trasparente.

EN Neutral display cases. Structure in stainless steel **AISI 304** - clear Plexiglas sides and doors on both sides .

FR Vitrines neutres. Structure en acier inox **AISI 304** - côtés et portes des deux côtés en plexiglass transparent.

DE Neutrale Vitrinen. Struktur aus Edelstahl **AISI 304** - Seiten und Türen auf beiden Seiten aus transparentem Plexiglas.

	VBN 4756	VBN 4786
 N.	2	
	50 x 35 x 40(h) cm	85 x 35 x 40(h) cm
	390 €	495 €

Vetrine neutre
Neutral display

VBN 4751 - VBN 4781
 VBN 4752 - VBN 4782
 VBN 4753 - VBN 4783



VBN 4751

IT Vetrine neutre. Struttura in acciaio inox **AISI 304** - fianchi e antine sui due fronti in plexiglass trasparente .

EN Neutral display cases. Structure in stainless steel **AISI 304** - clear Plexiglas sides and doors on both sides.

FR Vitrines neutres. Structure en acier inox **AISI 304** - côtés et portes des deux côtés en plexiglass transparent.

DE Neutrale Vitrinen. Struktur aus Edelstahl **AISI 304** - Seiten und Türen auf beiden Seiten aus transparentem Plexiglas.

VBE 50



VBE 85





IT Vetrina porta brioches e croissant. Struttura unica completamente in plexiglass con antine apribili sui due lati.

EN Brioches and croissants display case. Single structure completely in Plexiglas with openable doors on both sides.



FR Vitrine pour brioches et croissants. Structure unique entièrement en plexiglas avec portes qui peuvent être ouvertes des deux côtés.

DE Vitrine für Croissants und Hörnchen. Struktur komplett aus Plexiglas mit zweiseitig aufklappbaren Türen.

	VBE 50	VBE 85
 N.	1	
 cm	50 x 35 x 18(h) cm	85 x 35 x 18(h) cm
	170 €	230 €

	VBN 4751	VBN 4781	VBN 4752	VBN 4782	VBN 4753	VBN 4783
 N.	1		2		3	
 cm	50 x 35 x 25(h) cm	85 x 35 x 25(h) cm	50 x 35 x 36(h) cm	85 x 35 x 36(h) cm	50 x 35 x 50(h) cm	85 x 35 x 50(h) cm
	240 €	320 €	385 €	490 €	510 €	645 €

VL 4748
VL 4749

 NOCE/WALNUT
  WENGÉ
  BIANCO/WHITE



VL 4748W



VL 4749



VL 4748B

IT Vetrina porta brioches e croissant. Piano in legno - disponibile nei colori noce, wengé e bianco. Cupola in plexiglass semitrasparente con antine apribili sui 2 lati.

EN Brioches and croissants display case. Wooden top - available in walnut, wengé and white colour. Semi-transparent Plexiglas dome with openable doors on 2 sides.

FR Vitrine pour brioches et croissants. Plan en bois - disponible en noyer, wengé et blanc. Clochette en plexiglas semi-transparent avec portes qui peuvent être ouvertes des deux côtés.

DE Vitrine für Croissants und Hörnchen. Holzplatte - erhältlich in Nussbaum, Wenge und Weiß. Halbtransparente Plexiglashaube zweiseitig aufklappbare Türen.

	VL 4748 noce/walnut	VL 4748W wengé	VL 4748B bianco/white	VL 4749 noce/walnut	VL 4749W wengé	VL 4749B bianco/white
	1					
	50 x 35 x 21(h) cm			85 x 35 x 21(h) cm		
	210 €		220 €	250 €		265 €

Vetrine neutre
Neutral display

VPH 100 - VPH 120 VPH 160



VPH 100

IT Vetrine riscaldate con griglie - doppio vetro - struttura in acciaio inox **AISI 304** - fianchi e antine sui due fronti in plexiglass trasparente - termostato regolabile.

EN Heated display cases, with grids - double-glazed - structure in stainless steel **AISI 304** - clear Plexiglas sides and doors on both sides - adjustable thermostat.

FR Vitrines chauffées, avec grilles - double vitrage - structure en acier inox **AISI 304** - côtés et portes des deux faces en plexiglas transparent - thermostat réglable.

DE Beheizte Vitrinen, mit Gitter - Doppelglas - Struktur aus Edelstahl **AISI 304** - Seiten und Türen auf beiden Seiten aus transparentem Plexiglas - einstellbarer Thermostat.

	VPH 100	VPH 120	VPH 160
	1100 W		
	230V/ 50-60 HZ		
	+30° +90°C		
	2 piani - 2 griglie 2 shelves - 2 grids		
	71 x 46 x 67(h) cm GRC100A 643x272 mm GRC100B 643x303 mm	71 x 58 x 67(h) cm GRC120A 643x374 mm GRC120B 643x402 mm	88 x 58 x 67(h) cm GRC160A 819x374 mm GRC160B 819x407 mm
	920 €	1.200 €	1.440 €

MS 1860RF2 MS 1862RF2 MS 1866RF2



MS 1862

IT Mobiletto scaldapiatti. Struttura in acciaio inox **AISI 304** - termostato regolabile - 1 ripiano intermedio coibentato - ruote multidirezionali ø 95 mm di cui 2 con freno.

EN Plate warmer cabinet. **AISI 304** stainless steel structure - adjustable thermostat - 1 insulated intermediate shelf - multidirectional wheels ø 95 mm - 2 wheels with brake.

FR Armoire chauffe-plat. Structure en acier inox **AISI 304** - thermostat réglable - 1 étagère intermédiaire isolée - roues multidirectionnelles de ø 95 mm - 2 roues avec frein.

DE Tellerwärmer Schrank. Struktur aus Edelstahl **AISI 304** - einstellbarer Thermostat - 1 isolierte Zwischenablage - Mehrwegräder ø 95 mm - 2 mit Bremse.

	MS 1860RF2	MS 1862RF2	MS 1866RF2
	800 W		
	230V/ 50-60 HZ		
	+30° +90°C		
	60 piatti / plates 1 porta/door	100 piatti / plates 2 porte/ doors	120 piatti / plates 2 porte/ doors
	39 x 42 x 95(h) cm	70 x 42 x 80(h) cm	70 x 42 x 95(h) cm
	1.125 €	1.230 €	1.400 €

Mobiletto scaldapiatti
Plate warmer cabinets

forcar®

RTR 97L



RTR 97L2



RTR 137L









IT Vetrine riscaldate, da banco con griglie - doppio vetro - struttura in acciaio inox **AISI 304** - fianchi e antine sui due fronti in plexiglass trasparente - termostato regolabile.

EN Heated display cases, counter-top versions with grids - double-glazed - structure in stainless steel **AISI 304** - clear Plexiglas sides and doors on both sides - adjustable thermostat.

FR Vitrines chauffées, de table avec grilles - double vitrage - structure en acier inox **AISI 304** - côtés et portes des deux faces en plexiglas transparent - thermostat réglable.

DE Beheizte Vitrinen, Tischmodell mit Gitter - Doppelglas - Struktur aus Edelstahl **AISI 304** - Seiten und Türen auf beiden Seiten aus transparentem Plexiglas - einstellbarer Thermostat.

	RTR 97L	RTR 97L2	RTR 137L
			
	400 W		
 1 Ph	230V/ 50-60 HZ		
	+30° +90°C		
 N.	3 piani / shelves	4 piani tondi rotanti 4 rotating round shelves	3 piani / shelves
 cm	46 x 45 x 78,5(h) cm		64,5 x 45 x 78,5(h) cm
	930 €	1.035 €	1.065 €

Vetrine riscaldanti con griglie
Heated display cases with grids



Carrelli per la cucina

KITCHEN TROLLEYS
CHARIOTS POUR LA CUISINE
KÜCHENWAGEN

CA 1450



CA 1460



CA 1470



IT Carrelli portavassoi. Struttura e guide in acciaio inox - paracolpi in gomma - ruote multidirezionali \varnothing 125 mm. Predisposti di serie per vassoi GN1/1 - 53x32,5 cm. Realizzabili su richiesta per qualsiasi misura di vassoio, da specificare al momento dell'ordine.

EN Tray trolleys - Stainless steel structure and slides - rubber shock absorbers - multidirectional wheels \varnothing 125 mm. Standard equipped for GN1/1 trays - 53x32,5 cm. Available on request for any tray size, to be mentioned when ordering.

FR Chariots porte plateaux. Structure et guides en acier inox - butoirs en caoutchouc - roues multidirectionnelles \varnothing 125 mm. Prêt en standard pour plateaux GN1/1 - 53x32,5 cm. Disponible sur demande pour toute taille de plateau, à préciser à la commande.

DE Tablettwagen - GN1/1. Struktur und Führungen aus Edelstahl - Gummistoßschutz - Mehrwegräder \varnothing 125 mm. Standardmäßig vorgesehen für Bleche GN1/1 - 53x32,5 cm. Erhältlich auf Anfrage für jede Blechgröße, bitte bei der Bestellung angeben.

	CA 1450	CA 1460	CA 1470
	45 x 62 x 175(h) cm	81 x 62 x 175(h) cm	117 x 62 x 175(h) cm
	10 vassoi / trays	20 vassoi / trays	30 vassoi / trays
	395 €	605 €	825 €

Carrelli portavassoi GN1/1
GN1/1 tray trolleys

OPTIONAL



CA 1450P

CA 1460P

CA 1470P



h 12 cm



h 12 cm



h 12 cm

PANNELLI
LATERALI
SIDE
PANELS



BIANCO/WHITE



INOX



WENGÉ

IT Carrelli portavassoi con pannelli laterali in perfix bianco, acciaio inox o wengé. Struttura e guide in acciaio inox - paracolpi in gomma - ruote multidirezionali \varnothing 125 mm. Predisposti di serie per vassoi GN1/1 - 53x32,5 cm. Realizzabili su richiesta per qualsiasi misura di vassoio e/o con pannello posteriore, da specificare al momento dell'ordine.

FR Chariots porte plateaux à panneaux latéraux en perfix blanc, acier inox ou wengé. Structure et guides en acier inox - butoirs en caoutchouc - roues multidirectionnelles \varnothing 125 mm. Prêt en standard pour plateaux GN1/1 - 53x32,5 cm. Disponible sur demande pour toute taille de plateau et / ou avec panneau arrière, à préciser à la commande.

EN Tray trolleys with side panels in white perfix, stainless steel or wengé. Stainless steel structure and slides - rubber shock absorbers - multidirectional wheels \varnothing 125 mm. Standard equipped for GN1/1 trays - 53x32,5 cm. Available on request for any tray size and/or with rear panel, to be mentioned when ordering.

DE Tablettwagen mit Seitenwänden in Weiß Perfix, Edelstahl oder Wenge. Struktur und Führungen aus Edelstahl - Gummistoßschutz - Mehrwegräder \varnothing 125 mm. Standardmäßig vorgesehen für Bleche GN1/1 - 53x32,5 cm. Erhältlich auf Anfrage für jede Blechgröße und / oder mit Rückwand, bitte bei der Bestellung angeben.

	CA1450P bianco-white	CA1450PI inox	CA1450PW wengé	CA1460P bianco-white	CA1460PI inox	CA1460PW wengé	CA1470P bianco-white	CA1470PI inox	CA1470PW wengé
	45 x 62 x 175(h) cm			81 x 62 x 175(h) cm			117 x 62 x 175(h) cm		
	10 vassoi / trays			20 vassoi / trays			30 vassoi / trays		
	460 €	530 €	530 €	660 €	815 €	725 €	875 €	1.010 €	1.010 €

CA 1451R

CA 1461R

CA 1471R



PANNELLI
LATERALI
SIDE
PANELS





IT Carrelli portavassoi rinforzati, disponibili anche con pannelli laterali in perfix bianco o in acciaio inox. Struttura tubolare in acciaio inox 25x25 cm - guide in acciaio inox di spessore 1,2 mm - paracolpi in gomma - ruote multidirezionali \varnothing 125 mm. Predisposti di serie per vassoi GN1/1 - 53x32,5 cm. Realizzabili su richiesta per qualsiasi misura di vassoio e/o con pannello posteriore, da specificare al momento dell'ordine.

EN Reinforced tray trolleys also available with side panels in white perfix or stainless steel. Stainless steel tubular structure 25x25 mm - stainless steel slides with 1,2 mm thickness - rubber shock absorbers - multidirectional wheels \varnothing 125 mm. Standard equipped for GN1/1 trays - 53x32,5 cm. Available on request for any tray size and/or with rear panel, to be mentioned when ordering.

FR Chariots à plateaux renforcés disponibles aussi avec panneaux latéraux en perfix blanc ou acier inox. Structure tubulaire en acier inox 25x25 cm - guides en acier inox épaisseur 1,2 mm - butoir en caoutchouc - roues multidirectionnelles \varnothing 125 mm. Prêt en standard pour plateaux GN1/1 - 53x32,5 cm. Disponible sur demande pour toute taille de plateau et / ou avec panneau arrière, à préciser à la commande.

DE Verstärkte Tablettwagen auch mit Seitenwänden aus weißem Perfix oder Edelstahl erhältlich. Struktur aus Edelstahl 25x25 mm - 1,2 mm dicke Edelstahlführungen - Gummistoßschutz - Mehrwegräder \varnothing 125 mm. Standardmäßig vorgesehen für Bleche GN1/1 - 53x32,5 cm. Erhältlich auf Anfrage für jede Blechgröße und / oder mit Rückwand, bitte bei der Bestellung angeben.

	CA1451R	CA1451RP bianco-white	CA1451RPI inox	CA1461R	CA1461RP bianco-white	CA1461RPI inox	CA1471R	CA1471RP bianco-white	CA1471RPI inox
	45 x 62 x 174(h) cm			81 x 62 x 174(h) cm			118 x 62 x 174(h) cm		
	10 vassoi / trays			20 vassoi / trays			30 vassoi / 30 trays		
	520 €	570 €	680 €	835 €	880 €	985 €	1.120 €	1.190 €	1.290 €

Carrelli portavassoi rinforzati GN1/1
GN1/1 tray trolleys - reinforced

OPTIONAL



CA 1455

CA 1465

CA 1475



PANNELLI
LATERALI
SIDE
PANELS



IT Carrelli portavassoi universali con possibilità di avere pannelli laterali in perfix bianco o in acciaio inox. Struttura in acciaio inox - guide in filo di acciaio cromato - paracolpi in gomma - ruote multidirezionali ø 125 mm. Bacinelle e teglie escluse.

FR Chariots à plateaux universels isponibles aussi avec panneaux latéraux en perfix blanc ou acier inox. Structure en acier inox - glissières en fil d'acier chromé - butoirs en caoutchouc - roues multidirectionnelles ø 125 mm. Bacs et plaques pas compris.

EN Universal tray trolleys also available with side panels in white perfix or stainless steel. Stainless steel structure - chromed steel wire slides - rubber shock absorbers - multidirectional wheels ø 125 mm. Containers and pans not included.

DE Universal-Tablett Wagen auch mit Seitenwänden aus weißem Perfix oder Edelstahl erhältlich. Struktur aus Edelstahl - verchromte Stahldrahtführungen - Gummistoßschutz - Mehrwegräder ø 125 mm. Behältern und Bleche nicht enthalten.

	CA 1455	CA 1455P bianco-white	CA 1455PI inox	CA1465	CA1465P bianco-white	CA1465PI inox	CA1475	CA1475P bianco-white	CA1475PI inox
	55 x 62 x 175(h) cm			95 x 62 x 175(h) cm			138 x 62 x 175(h) cm		
	10 vassoi / trays			20 vassoi / trays			30 vassoi / trays		
	385 €	460 €	595 €	600 €	670 €	805 €	805 €	880 €	1.015 €

CA 1455V12

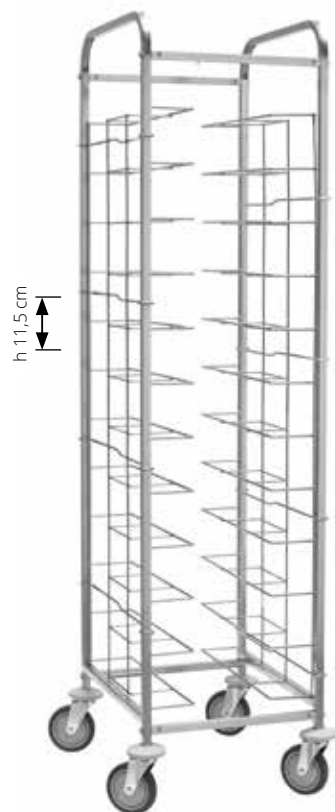

PT 15

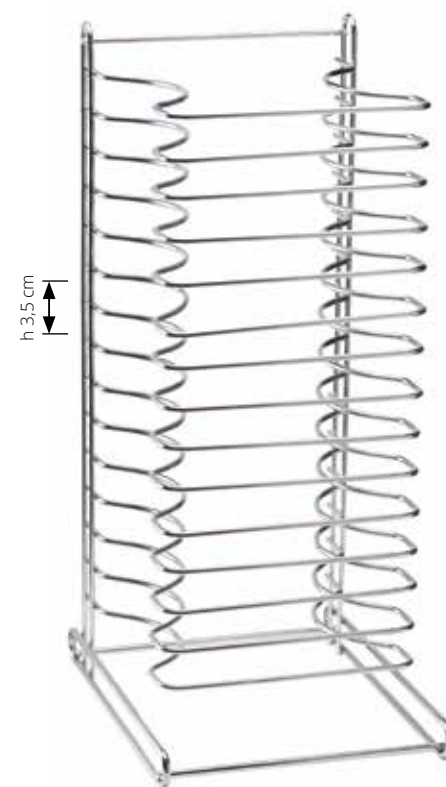

IT Carrelli portavassoi universali con possibilità di avere pannelli laterali in perfex bianco o in acciaio inox. Struttura in acciaio inox - guide in filo di acciaio cromato - paracolpi in gomma - ruote multidirezionali \varnothing 125 mm.

EN Universal tray trolleys. Stainless steel structure - chromed steel wire slides - rubber shock absorbers - multidirectional wheels \varnothing 125 mm.

FR Chariots à plateaux universels. Structure en acier inox - glissières en fil d'acier chromé - butoirs en caoutchouc - roues multidirectionnelles \varnothing 125 mm.

DE Universal-Tablett Wagen. Struktur aus Edelstahl - verchromte Stahldrahtführungen - Gummistoßschutz - Mehrwegräder \varnothing 125 mm.

IT Portateglie da banco per teglie tonde da cm. 26 a 32. Confezione minima 4 pz.

EN Table-top tray holder for round trays size 26 to 32 cm. Minimum pack 4 pcs.

FR Porte-plateau de table pour plateaux ronds de 26 à 32 cm. Paquet minimum de 4 pièces.

DE Tisch-Tabletthalterung für runde Tablette von 26 bis 32 cm. Mindestmenge 4 Stück.

	CA 1455V12
	52 x 62 x 185(h) cm
	12 vassoi / trays
	395 €

	PT 15
	38 x 29 x 67(h) cm
	15 teglie / trays
	90 €

Carrelli portavassoi universali
Universal tray trolleys

CA 1476

CA 1477

CA 1478

CA 1479



IT Carrelli portateglie GN. Struttura e guide in acciaio inox - paracolpi in gomma - ruote multidirezionali \varnothing 125 mm. Predisposti di serie per GN2/1. A richiesta possibilità di altre misure. Teglie escluse.

EN GN pans trolleys Stainless steel structure and slides - rubber shock absorbers - multidirectional wheels \varnothing 125 mm. Standard equipped for GN2/1. Other sizes available on request. Trays not included.

FR Chariots à plateaux GN. Structure et glissières en acier inox - butoirs en caoutchouc - roues multidirectionnelles \varnothing 125 mm. En standard pour GN2/1. Autres mesures disponibles sur demande. Plateaux pas compris.

DE GN-Blechwagen. Struktur und Führungen aus Edelstahl - Gummistoßschutz - Mehrwegräder \varnothing 125 mm. Serienmäßig ausgerüstet für GN2/1. Andere Größen sind auf Anfrage erhältlich. Bleche nicht enthalten.

	CA 1476	CA 1477	CA 1478	CA 1479
				
	64,5 x 72 x 182(h) cm	64,5 x 62 x 94(h) cm	44,5 x 62 x 94(h) cm	44,5 x 62 x 175(h) cm
	14 x GN2/1 - 28 x GN1/1	8 x GN2/1 - 16 x GN1/1	8 x GN1/1	14 x GN1/1
	530 €	570 €	500 €	470 €

CA 1489R

CA 1486R

CA 1492R



AV4947 60 x 30 x 2(h) cm	AV4937 60 x 40 x 2(h) cm
Teglia Blurex - Blurex tray Plaque Blurex - Blurex Form	
	
23 €	
AV4950 60 x 30 x 2(h) cm	AV4940 60 x 40 x 2(h) cm
Teglia alluminata - Aluminized pan Pan aluminisé - Aluminisierte pan	
	
25 €	
AV4980 60 x 40 x 2(h) cm	
Teglia in alluminio - Aluminium tray Plateau en aluminium Aluminiumschale	
	
32 €	

IT Carrelli portateglie GN rinforzati. Struttura tubolare in acciaio inox 25x25 cm - guide in acciaio inox di spessore 1,2 mm - paracolpi in gomma - ruote multidirezionali ø 125 mm. Teglie escluse.

FR Chariots à plateaux GN renforcés. Structure tubulaire en acier inox 25x25 cm - glissières en acier inox épaisseur 1,2 mm - butoir en caoutchouc - roues multidirectionnelles ø 125 mm. Plateaux pas compris.

EN GN pans trolleys - reinforced Stainless steel tubular structure 25x25 mm - stainless steel slides with 1,2 mm thickness - rubber shock absorbers - multidirectional wheels ø 125 mm. Trays not included.

DE Verstärkte GN-Blechwagen. Edelstahlrohrstruktur 25x25 cm - 1,2 mm dicke Edelstahlführungen - Gummistoßschutz - Mehrwegräder ø 125 mm. Bleche nicht enthalten.

	CA 1489R	CA 1486R	CA 1492R
	45,5 x 62 x 177(h) cm	65,5 x 72 x 181(h) cm	53 x 72 x 181(h) cm
	14 x GN1/1	14 x GN2/1 - 28 x GN1/1	teglie / trays 60 x 40 cm
	620 €	665 €	600 €

Carrelli portateglie rinforzati GN1/1 - GN2/1 - 60x40 cm
GN1/1 - GN2/1 - 60x40 cm pans trolleys - reinforced

OPTIONAL



CA 1650 - CA 1655 CA 1656



CA 1656

CA 1650

CA 1482 - CA 1482 T20 CA 1483 - CA 1493



CA 1482

CA 1483

IT Carrelli portateglie 60x40 cm e porta bacinelle GN1/1 65(h) mm. Struttura in acciaio inox - guide in filo di acciaio cromato - paracolpi in gomma - ruote multidirezionali Ø 125 mm. Bacinelle e teglie escluse.

EN Tray trolleys 60x40 cm and trays GN1/165(h) mm. Stainless steel structure - chromed steel wire slides - rubber shock absorbers - multidirectional wheels Ø 125 mm. Containers and pans not included.

FR Chariots à plateaux 60x40 cm et pour bacs GN1/1 65(h) mm. Structure en acier inox - glissières en fil d'acier chromé - butoirs en caoutchouc - roues multidirectionnelles Ø 125 mm. Bacs et plaques pas compris.

DE Tablett Wagen 60x40 cm und Tablett GN1/1 65(h) mm. Struktur aus Edelstahl - verchromte Stahldrahtführungen - Gummistoßschutz - Mehrwegräder Ø 125 mm. Behältern und Bleche nicht enthalten.

IT Carrelli portateglie per pasticceria. Struttura e guide in acciaio inox - paracolpi in gomma - ruote multidirezionali Ø 125 mm. A richiesta altre misure disponibili. Teglie escluse.

EN Pastry tray trolleys Stainless steel structure and slides - rubber shock absorbers - multidirectional wheels Ø 125 mm. Other sizes available on request. Trays not included.

FR Chariots à plateaux pâtisserie. Structure et glissières en acier inox - butoirs en caoutchouc - roues multidirectionnelles Ø 125 mm. Autres mesures disponibles sur demande. Plateaux pas compris.

DE Konditorei-Blechwagen. Struktur und Führungen aus Edelstahl - Gummistoßschutz - Mehrwegräder Ø 125 mm. Andere Größen sind auf Anfrage erhältlich. Bleche nicht enthalten.

	CA 1655	CA 1656	CA 1650
	67 x 46 x 117(h) cm	67 x 46 x 153(h) cm	51,5 x 67 x 175(h) cm
	GN1/1 65(h) mm 10 teglie / trays 60x40 cm	GN1/1 65(h) mm 15 teglie / trays 60x40 cm	GN1/1 65(h) mm 10 teglie/trays - 60x40 cm e vassoi / trays
	380 €	465 €	450 €

	CA 1482	CA 1482 T20	CA 1483	CA 1493
	52 x 72 x 182(h) cm		52 x 72 x 94(h) cm	72 x 87 x 94(h) cm
	14 teglie / trays 60 x 40 cm	20 teglie / trays 60 x 40 cm	8 teglie / trays 60 x 40 cm	8 teglie / trays 80 x 60 cm 16 teglie / trays 60 x 40 cm
	495 €	610 €	530 €	625 €

CA 1480

CA 1480D

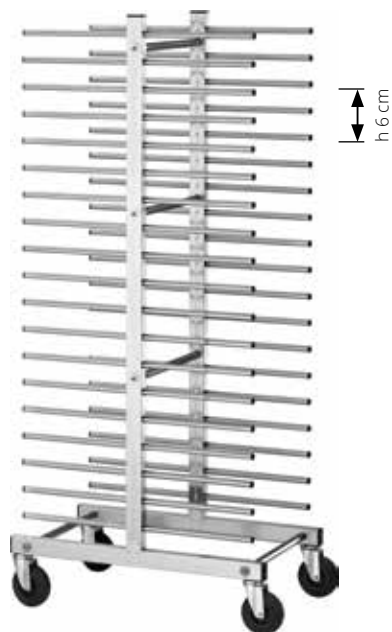

IT Carrelli portateglie universali. Struttura e guide in acciaio inox - paracolpi in gomma - ruote multidirezionali \varnothing 125 mm. Teglie escluse

EN Universal tray trolleys. Stainless steel structure and slides - rubber shock absorbers - multidirectional wheels \varnothing 125 mm. Trays not included.

FR Chariots à plateaux universels. Structure et glissières en acier inox - butoirs en caoutchouc - roues multidirectionnelles \varnothing 125 mm. Plateaux pas compris.

DE Universal-Blechwagen. Struktur und Führungen aus Edelstahl - Gummistoßschutz - Mehrwegräder \varnothing 125 mm. Bleche nicht enthalten.

	CA 1480	CA 1480D
	50 x 51 x 177(h) cm	50 x 81 x 177(h) cm
	20 teglie / trays	40 teglie / trays
	540 €	650 €

Carrelli portateglie per pasticceria rinforzati
Reinforced pastry tray trolleys

Optional

**FUORI PRODUZIONE
OUT OF PRODUCTION**

A510

Porte-bouteilles en ABS
ABS Flaschenhalter

A500

Bacinella portabottiglie
in acciaio inox
Stainless steel bottle tray
Porte-bouteilles en acier inox
Edelstahl Flaschenhalter

120 €



A 512

Ruote con freno - Wheels with catch
Roues avec frein - Räder mit Bremse

CA1450-CA1455-CA1460-CA1470-CA1465-CA1475-CA1477-CA1476-
CA1478-CA1479-CA1480-CA1480D-CA1482-CA1482T20-CA1483-CA1493

10 € cad./each

A 514

Ruote con freno - Wheels with catch
Roues avec frein - Räder mit Bremse

CA1451-CA1461-CA1471-CA1489R-CA1486R-CA1492

13 € cad./each



A 512

A 514



Carrelli portapiatti e cestelli

PLATE AND BASKETS TROLLEYS
PORTE-ASSIETTES ET PANIERS
TELLER- UND KORBWAGEN

CA 1435
CA 1436
CA 1435G
CA 1436G



GRIGLIA
VERNICIATA
PAINTED
GRID



WARNING
Dimensioni imballo
Packing dimensions
35 x 90 x 50(h) cm

GRIGLIA
CROMATA
CHROME
PLATED GRID

CA 1435

CA 1437
CA 1438
CA 1437G
CA 1438G

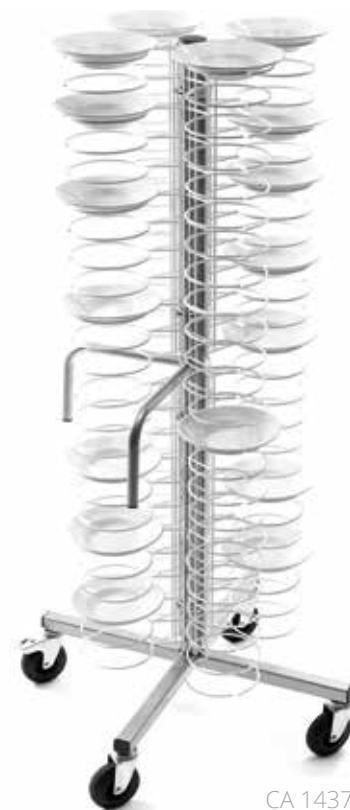

GRIGLIA
VERNICIATA
PAINTED
GRID



WARNING
Dimensioni imballo
Packing dimensions
35 x 165 x 50(h) cm

GRIGLIA
CROMATA
CHROME
PLATED GRID

CA 1437

IT Colonna portapiatti da banco. Struttura in acciaio plastificato - griglie verniciate o cromate - piedini regolabili.

EN Countertop tiered plate holder stand. Plastic-coated steel structure - painted or chromed grids - adjustable feet.

FR Colonne porte-assiettes de table. Structure en acier plastifié - grilles peintes ou chromées - pieds réglables.



DE Tellerwagen, Tischmodell. Struktur aus kunststoffbeschichtetem Stahl - lackierte oder verchromte Gitter - verstellbare FüÙe.



IT Carrelli portapiatti. Struttura in acciaio plastificato - griglie verniciate o cromate - maniglie per conduzione carrello - ruote ø 125 mm di cui due con freno.

EN Plate trolleys. Plastic-coated steel structure - painted or chrome-plated grids - handles for trolley operation - ø 125 mm wheels, two of which with brakes.

FR Chariots à assiettes. Structure en acier plastifié - grilles peintes ou chromées - poignées pour l'entraînement du chariot - roues de ø 125 mm, dont deux avec freins.

DE Tellerwagen. Struktur aus kunststoffbeschichtetem Stahl - lackierte oder verchromte Gitter - Lenkergriff - Räder ø 125 mm, davon zwei mit Bremsen.

	CA 1435 griglie verniciate painted grid	CA 1436 griglie cromate chrome-plated grill	CA 1435G griglie verniciate painted grid	CA 1436G griglie cromate chrome-plated grill
	60 x 60 x 83(h) cm		70 x 70 x 83(h) cm	
	48 piatti / plates ø 18/23 cm		48 piatti / plates ø 25/31 cm	
	380 €	390 €	390 €	430 €

	CA 1437 griglie verniciate painted grid	CA 1438 griglie cromate chrome-plated grill	CA 1437G griglie verniciate painted grid	CA 1438G griglie cromate chrome-plated grill
	60 x 60 x 173(h) cm		70 x 70 x 173(h) cm	
	96 piatti / plates ø 18/23 cm		96 piatti / plates ø 25/31 cm	
	740 €	760 €	760 €	840 €

Portapiatti da banco
Table top plate rack



Confezionamento in kit per risparmio costi trasporto
Packing in set for saving transport charges
Emballage en kit pour sauver frais d'expédition
Verpackung in kit um Versandkosten zu sparen

CA 1439P



WARNING

Dimensioni imballo
Packing dimensions
40 x 165 x 68(h) cm
peso / weight 50 kg

Confezionamento in kit per risparmio costi trasporto
Packing in set for saving transport charges
Emballage en kit pour sauver frais d'expédition
Verpackung in kit um Versandkosten zu sparen



CA 1439 CA 1440 CA 1439G CA 1440G



GRIGLIA
VERNICIATA
PAINTED
GRID



WARNING



GRIGLIA
CROMATA
CHROME
PLATED GRID

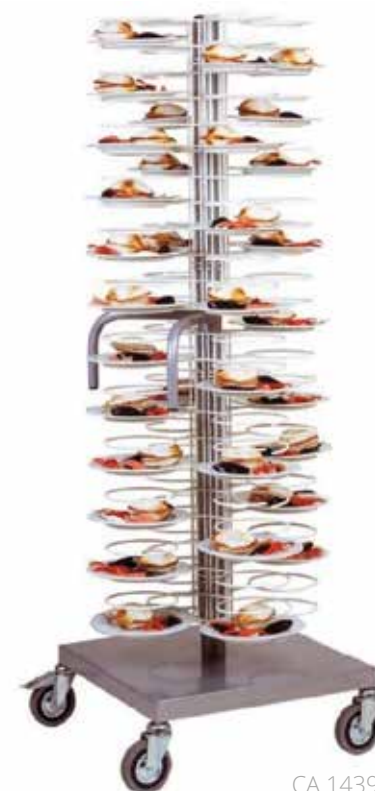

CA 1439

IT Portapiatti da parete. Struttura in acciaio plastificato - griglie plastificate.

EN Wall plate holder. Plastic-coated steel structure - plastic-coated grids.

FR Porte-assiettes à mur. Structure en acier plastifié - grilles plastifiées.

DE Wandtellerhalter. Kunststoffbeschichtete Stahlstruktur - beschichtete Gitter.

IT Carrelli portapiatti. Struttura in acciaio plastificato con base in lamiera antipolvere - griglie verniciate o cromate - maniglie per conduzione carrello - ruote ø 125 mm di cui due con freno.

EN Plate trolleys. Plastic-coated steel structure with dust-proof lower shelf - painted or chrome-plated grids - handles for trolley operation - ø 125 mm wheels, two of which with brakes.

FR Chariots à assiettes. Structure en acier plastifié avec base en tôle anti-poussière - grilles peintes ou chromées - poignées pour l'entraînement du chariot - roues de ø 125 mm, dont deux avec freins.

DE Tellerwagen. Struktur aus kunststoffbeschichtetem Stahl mit staubdichtem Boden - lackierte oder verchromte Gitter - Lenkergriff - Räder ø 125 mm, davon zwei mit Bremsen.

	CA 1439P
	42 x 20 x 90(h) cm
	12 piatti / plates ø 18/23 cm
	105 €

	CA 1439 griglie verniciate painted grid	CA 1440 griglie cromate chrome-plated grill	CA1439G griglie verniciate painted grid	CA1440G griglie cromate chrome-plated grill
	60 x 60 x 175(h) cm		70 x 70 x 175(h) cm	
	96 piatti / plates ø 18/23 cm		96 piatti / plates ø 25/31 cm	
	895 €	915 €	910 €	995 €

Portapiatti da parete
Wall plate rack

Carrelli portapiatti
Plate trolley

forcar

Optional

A 410 (mod.CA 1439-1440)	A 420 (mod.CA 1439G-1440G)
Copertura in PVC con 4 cerniere. PVC lid with 4 hinges. Couverture en PVC avec 4 charnières. PVC-Abdeckung mit 4 Scharnieren.	
300 €	350 €

A 512 (mod.CP 1441-1441C - CA 631-656-659)
Ruote con freno Wheels with catch Roues avec frein Räder mit Bremse
10 € cad./each

A 1001 (mod.CP 1441-1441C)	A 1002 (mod.CP 1441-1441C)
Cestino piccolo Small basket Petit panier Klein Korb	Cestino grande Big basket Grand panier Gros Korb
12 €	28 €



CP 1441 - CP 1441C



IT Carrelli per il trasporto piatti. Struttura in tubo di acciaio inox - ripiano portapiatti e pannellatura in lamiera di acciaio inox - ruote multidirezionali ø 125 mm.

EN Dish transport trolleys. Structure in stainless steel tube - stainless steel plate shelf and panelling - multidirectional wheels ø 125 mm.

FR Chariots pour transporter la vaisselle. Structure en tube d'acier inox - étagère et revêtement en tôle d'acier inox - roues multidirectionnelles ø 125 mm.

DE Geschirrwagen. Edelstahlrohrstruktur - Tellerablage und Verkleidung aus Edelstahlblech - Mehrwegräder ø 125 mm.

i	CP 1441	CP 1441C
↗ cm	91 x 57 x 101(h) cm	
N. ☰	1	2
☉	200 piatti / plates	
	565 €	725 €

CG 1439A

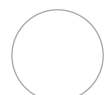

GRIGLIA
VERNICIATA
PAINTED
GRID



IT Carrelli portapiatti armati. Struttura portante in acciaio plastificato - telaio in alluminio anodizzato - pannellatura in perflex con 4 sportelli apribili in plexiglass - griglie verniciate o cromate - maniglie laterali per conduzione carrello - ruote multidirezionali \varnothing 125 mm di cui due con freno.

EN Cabinet plate trolleys. Supporting structure in plastic-coated steel - anodized aluminium frame - perflex panelling with 4 openable Plexiglas doors - painted or chrome-plated grids - side handles for trolley operation - multidirectional wheels \varnothing 125 mm, two of which with brakes.

FR Chariots porte-assiettes sur élément fermé. Structure portante en acier plastifié - corps en aluminium anodisé - panneaux en perflex avec 4 portes ouvrantes en plexiglas - grilles peintes ou chromées - poignées latérales pour le déplacement - roues multidirectionnelles \varnothing 125 mm dont deux avec frein.

DE Tellerwagen mit Schrankelement. Tragstruktur aus kunststoffbeschichtetem Stahl - Rahmen aus eloxiertem Aluminium - Blenden in Perflex mit 4 Flügeltüren aus Plexiglas - lackierte oder verchromte Gitter - seitliche Lenkergriffe - Mehrwegräder \varnothing 125 mm, zwei davon mit Bremsen.

	CG 1439A griglie verniciate / painted grid
	75 x 78 x 170(h) cm
	10 griglie verniciate GN2/1 - 10 painted grids GN2/1
	2.080 €

CA 1439A CA 1440A CA 1439AG CA 1440AG

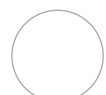

GRIGLIA
VERNICIATA
PAINTED
GRID



GRIGLIA
CROMATA
CHROME
PLATED GRID

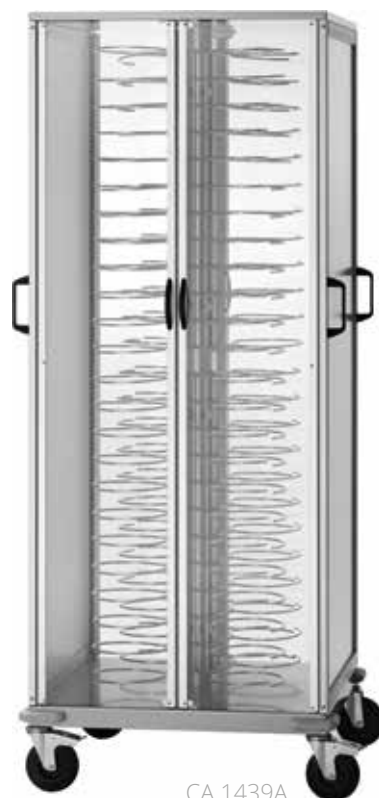

CA 1439A

	CA 1439A griglie verniciate painted grid	CA 1440A griglie cromate chrome-plated grill	CA 1439AG griglie verniciate painted grid	CA 1440AG griglie cromate chrome-plated grill
	75 x 78 x 183(h) cm			
	88 piatti / plates \varnothing 18/23 cm	88 piatti / plates \varnothing 18/23 cm	88 piatti / plates \varnothing 25/31 cm	88 piatti / plates \varnothing 25/31 cm
	1.825 €	1.890 €	1.835 €	1.940 €

CG 1439AC

GRIGLIA
VERNICIATA
PAINTED
GRID



IT Carrelli portapiatti armadiati e riscaldati. Struttura portante in acciaio plastificato-termostato regolabile - telaio in alluminio anodizzato - pannellatura in PERFEX con n. 4 sportelli apribili in plexiglass - griglie verniciate o cromate maniglie laterali per conduzione carrello - ruote ø 125 mm di cui due con freno.

EN Heated cabinet plate trolleys. Supporting structure in plastic-coated steel - adjustable thermostat - anodized aluminium frame - perfex panelling with 4 openable Plexiglas doors - painted or chrome-plated grids - side handles for trolley operation - multidirectional wheels ø 125 mm, two of which with brakes.

FR Chariots porte-assiettes chauffantes sur élément fermé. Structure portante en acier plastifié - thermostat réglable - corps en aluminium anodisé - panneaux en PERFEX avec 4 portes ouvrables en plexiglas - grilles chromées - poignées latérales pour le déplacement- roues ø 125 mm, dont deux avec frein.

DE Beheizter Tellerwagen und mit Schrankelement. Tragstruktur aus Kunststoffbeschichtetem Stahl. Einstellbarer Thermostat Rahmen aus eloxiertem Aluminium. Blenden in Perfex mit 4 Flügeltüren aus Plexiglas. Verchromte Gitter Seitliche Lenkergriffe - Räder diam. 125 mm, zwei davon mit Bremsen.

	CG 1439AC	
	800 + 800 W	
	230V/ 50-60 HZ	
	max 60°C	
	10 griglie verniciate GN2/1 / 10 painted grids GN2/1	
	75 x 78 x 177(h) cm	
	3.150 €	

CA 1440AC CA 1440ACG

GRIGLIA
CROMATA
CHROME
PLATED GRID

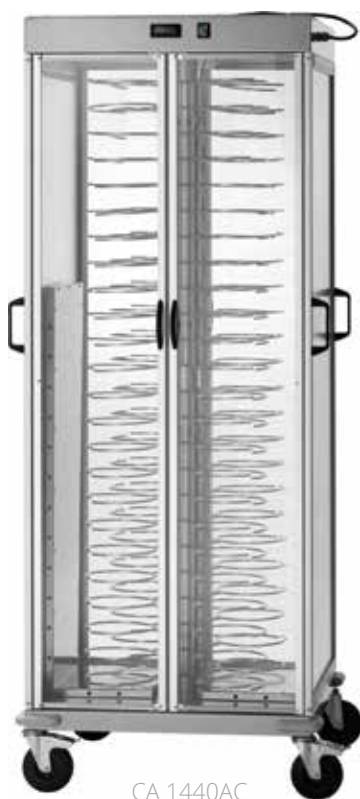

CA 1440AC

	CA 1440AC	CA1440ACG
	800 + 800 W	
	230V/ 50-60 HZ	
	max 60°C	
	88 piatti / plates ø 18/23 cm	88 piatti / plates ø 25/31 cm
	75 x 78 x 177(h) cm	
	2.830 €	2.880 €

Carrelli portapiatti armadiati riscaldati
Heated cabinet plate trolleys

CA 1439R CA 1439RG

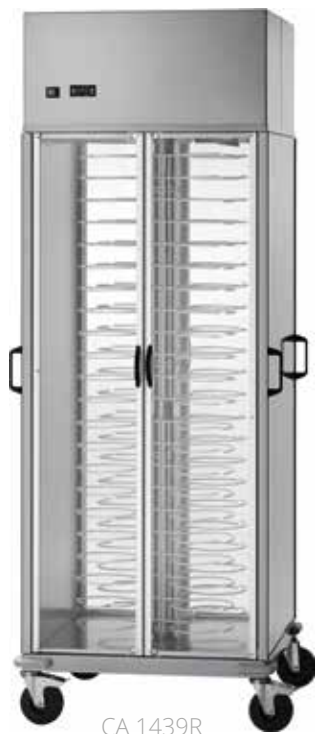

CA 1439R

CG 1439R



IT Carrelli portapiatti refrigerati. Struttura portante in acciaio plastificato - telaio in alluminio anodizzato - pannellatura in isomac spessore 25 mm con 4 sportelli apribili in plexiglass- griglie plastificate - maniglie laterali per conduzione carrello - ruote ø 125 mm di cui due con freno.

EN Refrigerated cabinet plate trolleys Supporting structure in plastic-coated steel - anodized aluminium frame - isomac panelling with 25 mm thickness and 4 openable Plexiglas doors - plastic coated grids - side handles for trolley operation - multidirectional wheels ø 125 mm, two of which with brakes.

FR Chariots porte-assiettes réfrigérées. Structure portante en acier plastifié - corps en aluminium anodisé - panneaux en isomac épaisseur 25 mm avec 4 portes ouvrantes en plexiglas - grilles plastifiées - poignées latérales pour le déplacement - roues ø 125 mm dont deux avec frein.

DE Gekühlte Tellerwagen. Tragstruktur aus kunststoffbeschichtetem Stahl - Rahmen aus eloxiertem Aluminium - 25 mm starke Isomac-Blenden mit 4 Flügeltüren aus Plexiglas - kunststoffbeschichtete Gitter - seitliche Lenkergriffe - Räder ø 125 mm, zwei davon mit Bremsen.

i	CA 1439R	CA 1439RG	CG 1439R
⚡	460 W		
🔌 1 Ph	230V/ 50-60 HZ		
🌡️	+8°C - +12 °C		
🔥	R290		
🍽️	88 piatti / plates ø 18/23 cm	88 piatti / plates ø 25/31 cm	10 griglie x GN2/1 10 grills x GN2/1
↗️ cm	75 x 78 x 203(h) cm		
	2.900 €	2.915 €	3.310 €

CA 656 - CA 631 - CA 659



CA 656



CA 631

**FUORI PRODUZIONE
OUT OF PRODUCTION**

CA 1399 CA 1400 CA 1401



CA 1399

IT Carrelli per ritiro, distribuzione e stoccaggio vassoi, piatti, tazze, ecc. Telaio in acciaio inox - cesti asportabili in filo di acciaio plastificato - paracolpi - ruote multidirezionali ø 125 mm.

EN Trolleys for collecting, distributing and storing trays, plates, cups, etc. Stainless steel frame - removable baskets made of plastic-coated steel wire - shock absorbers - multidirectional wheels ø 125 mm.

FR Chariots de collecte, de distribution et de stockage de plateaux, assiettes, tasses, etc. Structure en acier inox - paniers amovibles en fil d'acier plastifié - butoirs - roues multidirectionnelles ø 125 mm.

DE Wagen zum Sammeln, Verteilen und Lagern von Tablett, Tellern, Tassen usw. Edelstahlrahmen - abnehmbare Körbe aus kunststoffbeschichtetem Stahldraht - Stoßschutz - Mehrwegräder ø 125 mm.

IT Carrello scolapiatti e bicchieri. Telaio in tubo di acciaio inox - ripiani con griglie in acciaio inox per piatti - vaschette scola bicchieri in acciaio inox - piano raccogliacqua in acciaio inox - ruote multidirezionali ø 125 mm.



EN Plates and glasses drainer trolley. Stainless steel tubular frame - shelves with stainless steel grids for plates - stainless steel glass draining trays - stainless steel drip tray - multidirectional wheels ø 125 mm.

FR Chariot égouttoir assiettes et verres. Structure en tube d'acier inox - étagères avec grilles en acier inox pour assiettes - plateaux d'égouttage pour les verres en acier inox - cuve de récupération en acier inox - roues multidirectionnelles ø 125 mm.

DE Geschirr und Gläser Abtropfwagen. Edelstahlrohrrahmen - Stellflächen mit Edelstahlgittern für Teller - Abtropfschalen für Gläser aus Edelstahl - Tropfschale aus Edelstahl - Mehrwegräder ø 125 mm.

	CA 656	CA 631	CA 659
	88 x 50 x 92(h) cm	75 x 65 x 92(h) cm	
	1 cesto / basket	1 cesto / basket	2 cesto / baskets
	100 piatti / plates ø23 cm	130 vassoi / trays 53x32,5 / 37x53cm	200 piatti / plates ø23 cm
	450 €	350 €	-

**FUORI PRODUZIONE
OUT OF PRODUCTION**

	CA 1399	CA 1400	CA 1401
	110 x 62 x 134(h) cm		110 x 62 x 160(h) cm
	3 scolapiatti 3 plates drainers ø23 cm	1 scolabicchieri 1 glasses drainer 2 scolapiatti 2 plates drainers	4 scolapiatti 4 plates drainers
	830 €	960 €	1.025 €

Carrelli portapiatti per trasporto e ritiro
Plates transport and collection trolleys

Scolapiatti e bicchieri
Plates and glasses drainer

SPB 1398



SP 1397



IT Pensili scolapiatti e bicchieri da muro. Struttura in acciaio inox lucido 18/8.

EN Hanging plates and glasses drainer. Structure in 18/8 polished stainless steel.

FR Égouttoir mural pour assiettes et verres. Structure en acier inox poli 18/8.

DE Geschirr und Gläser Wandabtropfschränke. Struktur aus poliertem Edelstahl 18/8.

	SPB 1398	SP 1397
	80 x 26 x 37(h) cm ø23 cm	104 x 30 x 55(h) cm ø23 cm
	90 €	230 €

CP 1442



IT Carrelli portacestelli per lavastoviglie. Struttura tubolare in acciaio inox 50x50 cm. Ruote multidirezionali ø 125 mm - cestelli non inclusi.

EN Dishwasher trolleys. Stainless steel tubular structure 50x50 cm. Multidirectional wheels ø 125 mm - baskets not included.

FR Chariots pour lave-vaisselle. Structure tubulaire en acier inox 50x50 cm. Roues multidirectionnelles ø 125 mm - paniers pas compris.

DE Spülmaschinenwagen. 50x50 cm Edelstahlrohrstruktur. Mehrwegräder ø 125 mm - Körbe nicht enthalten.

	CP1442
	65 x 65 x 170(h) cm
	345 €

Scolapiatti e bicchieri
Plates and glasses drainer

Carrello portacestelli
Basket trolley

forcar

CP 1447 CP 1448



CP 1448

CP 1445 CP 1446



CP 1445

IT Carrelli portacestelli per lavastoviglie. Vasca in ABS - disponibile con o senza manico in acciaio inox - ruote multidirezionali ø 125 mm - cestelli non inclusi.

EN Dishwasher basket trolleys. ABS base - available with or without stainless steel handle - multidirectional wheels ø 125 mm - baskets not included.

FR Chariots porte-paniers pour lave-vaisselle. Fond en ABS - disponible avec ou sans poignée en acier inox - roues multidirectionnelles ø 125 mm - paniers pas compris.

DE Korbwagen für Geschirrspülerkörbe. ABS-Boden - mit oder ohne Edelstahlgriff erhältlich - Mehrwegräder ø 125 mm - Körbe nicht enthalten.

IT Carrelli portacestelli per lavastoviglie. Vasca in acciaio inox - disponibile con o senza manico in acciaio inox - ruote multidirezionali ø 125 mm. Ceste non incluse.

EN Dishwasher basket trolleys. Stainless steel base - available with or without stainless steel handle - multidirectional wheels ø 125 mm. Baskets not included.

FR Chariots porte-paniers pour lave-vaisselle. Fond en acier inox - disponible avec ou sans poignée en acier inox - roues multidirectionnelles ø 125 mm. Paniers pas compris.

DE Korbwagen für Geschirrspülerkörbe. Edelstahl Boden - mit oder ohne Edelstahlgriff erhältlich - Mehrwegräder ø 125 mm, Körbe nicht enthalten.

	CP 1447 con manico - with handle	CP 1448 senza manico - without handle
	53 x 56 x 92(h) cm	53 x 56 x 21(h) cm
	150 €	105 €

	CP 1445 con manico - with handle	CP 1446 senza manico - without handle
	52 x 58 x 96(h) cm	52 x 52 x 20(h) cm
	295 €	260 €

Carrello portacestelli
Basket trolley

OPTIONAL



CB 1444 - CB 1443



CB 1444

IT Carrelli per impasti pizza con cassette da 60x40 cm - interamente in acciaio inox - disponibile con o senza manico in acciaio inox - ruote multidirezionali ø 125 mm.

EN Pizza dough trolleys with 60x40 cm containers - entirely made of stainless steel - available with or without stainless steel handle - multidirectional wheels ø 125 mm.

FR Chariots à pâte à pizza avec bacs de 60x40 cm - entièrement en acier inox - disponible avec ou sans poignée en acier inox - roues multidirectionnelles ø 125 mm.

DE Pizzateigwagen mit 60x40 cm Behälter - komplett aus Edelstahl - mit oder ohne Edelstahlgriff erhältlich - Mehrwegräder ø 125 mm.

	CB 1444 con manico - with handle	CB 1443 senza manico - without handle
	72 x 42 x 96(h) cm	62 x 42 x 20(h) cm
	270 €	235 €

CB 1449



IT Carrello portacassette per impasti pizza 60x40 cm - senza manico - vasca in ABS - ruote multidirezionali ø 125 mm.

EN Trolley for Pizza dough containers 60x40 cm - without handle - ABS base - multidirectional wheels ø 125 mm.

FR Chariot à bacs pour pâte à pizza 60x40 cm - sans poignée - fond en ABS - roues multidirectionnelles ø 125 mm.

DE Wagen für Pizzateigbehälter 60x40 cm - ohne Griff - ABS-Boden - Mehrwegräder ø 125 mm.

	CB 1449
	62 x 42 x 16,5(h) cm
	80 €

Cestelli per lavastoviglie 50x50 cm

Dishwasher baskets 50x50 cm
Paniers pour lave-vaisselle 50x50 cm
Körbe für Geschirrspüler 50x50 cm



i	BVM	BV	B9	B16	B25	B36	B49	BP	BA
	base vuota h 90 mm col. grigio per posate	base vuota h 90 mm col. grigio universale	base 9 scomparti h 90 mm col. grigio (bicchiere diam. 140 mm)	base 16 scomparti h 90 mm col. grigio (bicchiere diam. 110 mm)	base 25 scomparti h 90 mm col. grigio (bicchiere diam. 80 mm)	base 36 scomparti h 90 mm col. grigio (bicchiere diam. 70 mm)	base 49 scomparti h 90 mm col. grigio (bicchiere diam. 60 mm)	base per piatti o vassoi h 90 mm col. grigio	base per vassoi aperto su un lato h 90 mm col. grigio
	23 €	23 €	25 €	26 €	28 €	29 €	32 €	24 €	21 €

i	RIAU	RIA9	RIA25	RIA36	RIA49	RIA16	CP8	COPCEST
	rialzo universale h 45 mm col. blu	rialzo 9 scomparti h 45 mm col. blu	rialzo 25 scomparti h 45 mm col. blu	rialzo 36 scomparti h 45 mm col. blu	rialzo 49 scomparti h 45 mm col. blu	rialzo 16 scomparti h 45 mm col. blu	cestellino inserto portaposate 8 scomparti	coperchio standard per cestelli
	12 €	13 €	13 €	15 €	14 €	13 €	15 €	17 €

DISPONIBILI ALTRI PRODOTTI NEL CATALOGO FIMAR
AVAILABLE OTHER PRODUCTS ON FIMAR CATALOGUE

Cestelli per lavastoviglie
Dishwasher baskets



Carrelli e articoli per il servizio in camera

TROLLEYS AND EQUIPMENT
FOR ROOM SERVICE
CHARIOTS ET ARTICLES
DE ROOM SERVICE
WAGEN UND AUSRÜSTUNG
FÜR DEN ZIMMERSERVICE

CB 980



CB 980

Esclusa cassetta
Boxes not included

CB 970

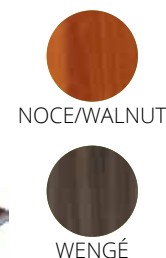

CB 970W

Esclusa cassetta
Boxes not included

IT Carrelli per la colazione. Struttura portante in tubo di acciaio inox - ripiano con antine ribaltabili in nobilitato - disponibile nei colori noce o wengé - ripiano di servizio ruotabile sino a 90°, con possibilità di incastrare i carrelli uno dentro l'altro per ridurre al minimo l'ingombro. Ruote multidirezionali di cui 2 con freno.

EN Breakfast trolleys. Supporting structure in stainless steel tube - shelf with melamine folding doors - available in walnut or wengé colour - service shelf that can be rotated up to 90°, trolleys can be pushed one inside the other to reduce the overall dimensions considerably. Multidirectional wheels, 2 with brake.

FR Chariots pour le petit déjeuner. Structure portante en tube d'acier inox - plan de travail avec volets en mélaminé - disponible en noyer ou wengé - plan de service pivotant jusqu'à 90°, les chariots peuvent être rangés les uns dans les autres pour réduire l'encombrement au minimum. Roues multidirectionnelles, dont 2 avec frein.

DE Frühstückswagen. Tragstruktur aus Edelstahlrohr - Abstellfläche mit Klapptüren aus Melamin - erhältlich in den Farben Nussbaum oder Wenge - bis zu 90° drehbare Ablagefläche, Wagen ineinander stapelbar, um die Außenmaße höchst möglichst zu reduzieren. Mehrwegräder, davon 2 mit Bremse.

	CB 980 noce-walnut	CB 980W wengé
	Open \varnothing 80 x 80(h) cm Closed 80 x 53 x 80(h) cm	
	535 €	

	CB 970 noce-walnut	CB 970W wengé
	Open 80 x 53 x 80(h) cm Closed 35 x 53 x 80(h) cm	
	535 €	

Carrelli per la colazione
Breakfast trolleys

CST 300







IT Casseta termica per scaldare piatti e prime colazioni. Contenitore interamente in acciaio inox - piano intermedio - termostato regolabile.

EN Heating box to warm plates and breakfasts. Container entirely in stainless steel - intermediate shelf - adjustable thermostat

FR Boîte thermique pour réchauffer les assiettes et les petits déjeuners. Corps entièrement en acier inox - étagère intermédiaire - thermostat réglable.

DE Wärmekiste zum Erwärmen von Teller und Frühstück. Kiste komplett aus Edelstahl - Zwischenboden - einstellbarer Thermostat.

	CST 300
	250 W
 1 Ph	230V/ 50-60 HZ
	+30° +60°C
 cm	39 x 37 x 46(h) cm - n.2 piatti /plates ø33 cm
	400 €

CPC 600

Cassette termiche non incluse
Boxes not included



IT Carrello porta cassette termiche Mod. CTS300 con allacciamento elettrico. Struttura tubolare 25x25 cm in acciaio inox - guide per contenere n.6 cassette termiche. Ruote ø 125 mm di cui 2 con freno. Cassette non incluse.

EN Heating boxes trolley Mod. CTS300 with electrical connection. Tubular structure 25x25 cm in stainless steel - slides to store 6 heating boxes. Wheels ø 125 mm 2 of which with brake. Boxes not included.

FR Chariot à boîtes thermiques Mod. CTS300 avec connexion électrique. Structure en tube d'acier inox 25x25 cm - glissières pour contenir 6 boîtes thermiques. Roues ø 125 mm dont 2 avec frein. Boîte pas compris.

DE Wagen für Wärmekiste Mod. CTS300 mit elektrischem Anschluss. Rohrstruktur 25x25 cm aus Edelstahl - Führungen für 6 Wärmekisten. Räder ø 125 mm davon 2 mit Bremse. Wärmekisten nicht enthalten.

	CPC 600
 1 Ph	230V/ 50-60 HZ
 cm	155 x 61 x 132(h) cm - ø33 cm
	470 €

PV 4062



PV 4064



PV 4055



PV 4056





IT Carrelli portavaligie e portabiti. Base in legno ricoperta da moquette colorata, disponibile nei colori rosso o blu - supporto asta in tubolare di acciaio ottonato o cromato da \varnothing 40 mm - bordo paracolpi perimetrale in gomma - ruote multidirezionali \varnothing 200 mm.

FR Chariots à bagages et porte-vêtements. Base en bois recouverte de moquette, disponible en rouge ou bleu - Support en tube d'acier tubulaire en laiton ou chromé \varnothing 40 mm - Bord de butoir périphérique en caoutchouc - Roues multidirectionnelles \varnothing 200 mm.

EN Luggage trolleys and clothes racks. Wooden base covered with coloured carpet, available in red or blue - rod support in brass-plated or chrome-plated steel tube \varnothing 40 mm - perimeter rubber shock absorber - multidirectional wheels \varnothing 200 mm.

DE Kofferwagen und Kleiderständer. Holzboden mit buntem Teppichboden, erhältlich in den Farben Rot oder Blau - Stabhalterung aus vermessingt oder verchromtem Stahlrohr \varnothing 40 mm - Gummistoßschutz - Mehrrichtungsräder \varnothing 200 mm.

	PV 4062	PV 4064	PV 4055	PV 4056
				
	95 x 55 x 190(h) cm		95 x 55 x 183(h) cm	
	Base rossa + Struttura ottone Red base + Brass structure	Base blu + Struttura cromata Blue base + Chromed structure	Base rossa + Struttura ottone Red base + Brass structure	Base blu + Struttura cromata Blue base + Chromed structure
	150 Kg			
	FUORI PRODUZIONE-OT OF PRODUCTION	1.015 €	FUORI PRODUZIONE-OT OF PRODUCTION	895 €

Carrelli portavaligie e portabiti
Luggage trolleys and clothes racks

PV 2001

PV 2001I



WARNING

PV 2021

PV 2021I



IT Carrelli portavaligie e portabiti. Base in legno ricoperta da moquette colorata, disponibile in rosso - supporto asta in tubolare di acciaio ottonato o inox da \varnothing 40 mm - bordo paracolpi perimetrale in gomma - ruote multidirezionali \varnothing 200 mm.

EN Luggage trolleys and clothes racks. Wooden base covered with coloured carpet, available in red - rod support in brass-plated steel or stainless steel tube \varnothing 40 mm - perimeter rubber shock absorber - multidirectional wheels \varnothing 200 mm.

FR Chariots à bagages et porte-vêtements. Base en bois recouverte de moquette, disponible en rouge - support en tube d'acier tubulaire en laiton ou acier inox \varnothing 40 mm - bord de butoir périphérique en caoutchouc - roues multidirectionnelles \varnothing 200 mm.

DE Chariots à bagages et porte-vêtements. Base en bois recouverte de moquette, disponible en rouge - support en tube d'acier tubulaire en laiton ou acier inox \varnothing 40 mm - bord de butoir périphérique en caoutchouc - roues multidirectionnelles \varnothing 200 mm.

IT Carrelli portavaligie e portabiti. Base in legno ricoperta da moquette colorata, disponibile nei colori rosso o nera - supporto asta in tubolare di acciaio ottonato o inox da \varnothing 40 mm - bordo paracolpi perimetrale in gomma - ruote pneumatiche \varnothing 200 mm.

EN Luggage trolleys and clothes racks. Wooden base covered with coloured carpet, available in red or black - rod support in brass-plated steel or stainless steel tube \varnothing 40 mm - perimeter rubber shock absorber - pneumatic wheels \varnothing 200 mm.

FR Chariots à bagages et porte-vêtements. Base en bois recouverte de moquette, disponible en rouge ou noir - support en tube d'acier tubulaire en laiton ou acier inox \varnothing 40 mm - bord de butoir périphérique en caoutchouc - roues pneumatiques \varnothing 200 mm.

DE Kofferwagen und Kleiderständer. Holzboden mit buntem Teppichboden, erhältlich in den Farben Rot oder Schwarz - Stabhalterung aus vermessingt Stahl oder Edelstahlrohr \varnothing 40 mm - Gummistoßschutz - Lufräder \varnothing 200 mm.

i	PV 2001	PV 2001I
cm	124 x 64 x 190(h) cm	
	Base rossa + Struttura ottone Red base + Brass structure	Base rossa + Struttura inox Red base + Stainless steel structure
MAX Kg	150 Kg	
	1.140 €	1.050 €

i	PV 2021	PV 2021I
cm	110 x 62 x 198(h) cm	
	Base rossa + Struttura ottone Red base + Brass structure	Base nero + Struttura inox Black base + Stainless steel structure
MAX Kg	150 Kg	
	1.000 €	990 €

122 Carrelli portavaligie e portabiti
Luggage trolleys and clothes racks



WARNING!

IL CARRELLO VIENE SPEDITO IN KIT SMONTATO
THE TROLLEY IS DELIVERED DISMOUNTED
LE CHEROÏT EST LIVRÉ DEMONTÉ
DER WAGEN IST DEMONTIERT GELIEFERT

car

PV 2002



PV 2002I



PV 2003



PV 2003I



IT Carrelli portavaligie. Base pieghevole e piani in legno ricoperti di moquette colorata rossa - struttura disponibile in acciaio ottonato o inox - 2 piedi di appoggio - ruote ø 250 mm.

FR Chariot à bagages. Base repliable et étagères en bois recouvertes de moquette de couleur rouge - structure disponible en acier laitonné ou en acier inox - 2 pieds de support - roues ø 250 mm.

EN Luggage trolleys. Foldable base and wooden shelves covered with red carpet - structure available in brass or stainless steel - 2 support feet - wheels ø 250 mm.

DE Kofferwagen. Klappboden und Holzabstellflächen mit rotem Teppichboden - Struktur wahlweise aus vermessingtem Stahl oder Edelstahl - 2 Standfüße - Räder ø 250 mm.

i	PV 2002	PV 2002I	PV 2003	PV 2003I
↗ cm	56 x 83 x 123(h) cm		56 x 70 x 120(h) cm	
	Base rossa + Struttura ottone Red base + Brass structure	Base rossa + Struttura inox Red base + Stainless steel structure	Base rossa + Struttura ottone Red base + Brass structure	Base rossa + Struttura inox Red base + Stainless steel structure
MAX Kg	100 Kg			
	300 €	280 €	245 €	210 €

PVI 4024



IT Carrello porta valigie e portabiti. Struttura in tubo di acciaio inox - base in lamiera d'acciaio inox - ruote multidirezionali \varnothing 140 mm, di cui 2 fisse.

EN Luggage trolley and clothes rack Structure in stainless steel tube - base in stainless steel plate - multidirectional wheels \varnothing 140 mm, 2 of which fixed.

FR Chariots à bagages et porte-vêtements. Structure en tube d'acier inox - base en tôle d'acier inox - roues multidirectionnelles \varnothing 140 mm, dont 2 fixes.

DE Kofferwagen und Kleiderständer. Struktur aus Edelstahlrohr - Boden aus Edelstahlblech - Mehrwegräder \varnothing 140 mm, 2 davon fest.

ST 4060



IT Stender portabiti. Struttura in tubo di acciaio cromato - asta allungabile di 30 cm per lato - ruote multidirezionali.

EN Clothes rack. Chrome-plated steel tube structure - rod can be extended by 30 cm on each side - multidirectional wheels.

FR Vêtements rack. Structure en tube d'acier chromé - bras extensible de 30 cm de chaque côté - roues multidirectionnelles.

DE Kleiderständer. Verchromte Stahlrohrstruktur - der Stab lässt sich auf jeder Seite um 30 cm verlängern - Mehrwegräder.

	PVI 4024
	100 x 56 x 160(h) cm
	200 Kg
	485 €

	ST 4060
	Open 210 x 53 x 152(h) cm Closed 150 x 53 x 152(h) cm
	112 €



RE 4016

FAGGIO/BEECH
WOOD

NOCE/WALNUT

RE 4018



FAGGIO/BEECH
WOOD

NOCE/WALNUT

IT Reggivaligie. Struttura in legno - telo in cotone.

EN Luggage holder. Wooden structure - cotton strap.

FR Supports de bagages. Structure en bois - toile de coton.

DE Kofferträger. Holzrahmen - Baumwolltuch.

**MERCE IN ESAURIMENTO ULTIMI PEZZI
OUT OF STOCK**

	RE 4016 faggio-beech wood	RE 4017 noce-walnut
	50 x 46 x 58(h) cm	
	65 €	

	RE 4018 faggio-beech wood	RE 4019 noce-walnut
	50 x 41 x 58(h) cm	
	65 €	

Reggi valigie
Luggage holder

CPB 1472 - CPB 1474



IT Carrello per trasporto pesante. Pianale basso in lamiera di acciaio inox - manico smontabile - ruote multidirezionali \varnothing 140 mm di cui 2 fisse e dotate di freno.

EN Trolleys for heavy transport Lower platform in stainless steel plate - removable handle - multidirectional wheels \varnothing 140 mm, 2 of which fixed and equipped with brake.

FR Chariot de transport lourd. Etagère basse en tôle d'acier inox - poignée amovible - roues multidirectionnelles \varnothing 140 mm, dont 2 fixes et équipées de freins.

DE Wagen für den Schwertransport. Niedrige Ladefläche aus Edelstahlblech - abnehmbarer Griff - Mehrwegräder \varnothing 140 mm, 2 davon fest und mit Bremse ausgestattet.

	CPB 1474	CPB 1472
	61 x 122 x 90(h) cm	61 x 110 x 85(h) cm
	1 manico 1 handle	2 manici 2 handles
	200 Kg	
	470 €	500 €

CA 1473





IT Carrello portacasse. Struttura in tubo di acciaio verniciato - ruote \varnothing 200 mm piene.

EN Trunk trolley. Structure in painted steel tube - \varnothing 200 mm full wheels.

FR Chariot pour caisse. Structure en tube d'acier peint - roues pleines \varnothing 200 mm.

DE Kistenwagen. Struktur aus lackiertem Stahlrohr - \varnothing 200 mm Vollräder.

	CA 1473
	50 x 45 x 105(h) cm
	200 Kg
	FUORI PRODUZIONE _ OUT OF PRODUCTION

ACF 5190



- IT Aste delimita corsie. Disponibili in diverse misure con nastro avvolgibile colorato rosso o blu - asta colore oro, acciaio inox o nera. Puntali in abbinamento.
- EN Retractable Barriers Available in different sizes with red or blue colored retractable belts - gold, stainless steel or black post. Matching caps.
- FR Délimiteur de zone. Disponible en différentes tailles avec ruban roulant de couleur rouge ou bleue - mât en or, acier inox ou noir. Pointe coordonnée.
- DE Begrenzungspfosten. Erhältlich in verschiedenen Größen mit rotem oder blauem Aufrollband - Gold, Edelstahl oder schwarze Pfosten. Passende Spitzen.



PU 5195

- IT Puntali in abbinamento delle aste delimita corsie a seconda del colore e materiale scelto.
- EN Caps matching the posts of the retractable barriers according to the colour and material chosen.
- FR Pointes coordonnées avec les mâts de délimitation des voies en fonction de la couleur et du matériau choisi.
- DE Spitzen passend zu den Begrenzungspfosten je nach Farbe und Material.

	ACF 5190 DB Blu-Blue	ACF 5190 DR Rosso-Red
	2 mt	
	Asta dorata Golden post	
	ACF 5190 IB Blu-Blue	ACF 5190 IR Rosso-Red
	2 mt	
	Asta acciaio lucido Polished steel post	
	ACF 5190 NB Blu-Blue	ACF 5190 NR Rosso-Red
	2 mt	
	Asta nera Black post	
	90 €	

	PU 5195 DB Blu-Blue	PU 5195 DR Rosso-Red	PU 5195 IB Blu-Blue	PU 5195 IR Rosso-Red	PU 5195 NB Blu-Blue	PU 5195 NR Rosso-Red
	Puntale dorato Gold cap		Puntale acciaio lucido Polished steel cap		Puntale nero Black cap	
	40 €					

Aste delimita corsia
Retractable barriers

AC 5118D AC 5118I



- IT Aste delimita corsie per cordoni a treccia. Puntali in abbinamento.
 EN Barriers posts for plaited cords. Matching caps.
 FR Délimiteur de zone pour cordons tressés. Pointe coordonnée.
 DE Begrenzungsposten für geflochtene Seile. Passende Spitzen.

i	AC 5118D	AC 5118I
↗ cm	90(h) cm	
	Asta dorata Golden post	Asta acciaio lucido Polished steel post
	90 €	



GA 5144D - GA 5144I

- IT Gancio a muro, disponibile in colore ottonato o cromato.
 EN Wall ring, available in brass or chrome colour.
 FR Anneau à mur, disponible en couleur laiton ou chromé.
 DE Wandhaken, erhältlich in vermessingter oder verchromter Farbe.



i	GA 5144D	GA 5144I
	Gancio ottonato Brass-plated wall ring	Gancio inox Stainless steel wall ring
	22 €	

CO 4099

- IT Cordone per aste. Colori: bordeaux, oro, verde, blu.
 EN Barriers cord. Colours: burgundy, gold, green, blue.
 FR Cordon pour délimiteur. Couleurs: bordeaux, or, vert, bleu.
 DE Begrenzungsseile. Farben: Burgunder, Gold, Grün, Blau.



i	CO4099	
↗ cm	ø 30 mm	
	45 € al metro / meter	

PU 5144D - PU 5144I

- IT Puntali in abbinamento delle aste delimita corsie per cordoni a treccia.
 EN Caps matching the posts of the barriers with plaited cords.
 FR Pointes coordonnées avec les mâts pour cordons tressés.
 DE Spitzen passend zu den Begrenzungsposten für geflochtene Seile.



i	PU 5144D	PU 5144I
	Puntale dorato Gold cap	Puntale acciaio lucido Polished steel cap
	25 €	

LU 4120



LU 4131



**FUORI PRODUZIONE
OUT OF PRODUCTION**

IT Macchina pulisci scarpe. Struttura in lamiera verniciata a polveri epossidiche - spazzole in cotone e crine - pulsante di accensione con temporizzatore elettrico. Dispensatore per crema - disponibile solo in colore bianco.

EN Shoe cleaner machine. Structure in metal plate painted with epoxy powders - cotton and horsehair brushes - power button with electric timer. Cream dispenser - available colors white.

FR Machine de nettoyage de chaussures. Structure en tôle peinte avec poudres époxy - brosses en coton et crin de cheval - bouton d'alimentation avec minuterie électrique. Distributeur de crème - disponible en blanc.

DE Schuhputzmaschine. Struktur aus mit Epoxidpulvern lackiertem Blech - Baumwoll- und Rosshaarbürsten - Einschaltknopf mit elektrischer Zeitschaltuhr. Cremespender - erhältlich in weiß.

IT Macchina pulisci scarpe. Struttura in lamiera verniciata a polveri epossidiche - spazzole in cotone e crine - pulsante di accensione con temporizzatore elettrico.

EN Shoe cleaner machine. Structure in metal plate painted with epoxy powders - cotton and horsehair brushes - power button with electric timer.

FR Machine de nettoyage de chaussures. Structure en tôle peinte avec poudres époxy - brosses en coton et crin de cheval - bouton d'alimentation avec minuterie électrique.

DE Schuhputzmaschine. Struktur aus mit Epoxidpulvern lackiertem Blech - Baumwoll- und Rosshaarbürsten - Einschaltknopf mit elektrischer Zeitschaltuhr.

	LU 4120
	150 W
	230V-50HZ
	62 x 30 x 83(h) cm
FUORI PRODUZIONE	

	LU 4131
	150 W
	230V-50HZ
	42 x 30 x 83(h) cm
OUT OF PRODUCTION	

Macchine pulisci scarpe
Shoe cleaner machines



Carrelli portabiancheria

riifornimento frigobar,pulizia e multiuso

LAUNDRY, MINIBAR, CLEANING
AND MULTI-PURPOSE TROLLEYS.
CHARIOTS À LINGE, REPLISSAGE MINIBAR,
NETTOYAGE ET POLYVALENT.
WÄSCHEREI-, MINIBAR-, REINIGUNGS- UND
MEHRZWECKWAGEN.

CA 1501



CA 1505



CA 1510



CA 1515



IT Carrelli portabiancheria. Struttura in acciaio inox - piani in laminato - in dotazione un sacco in tessuto ignifugo - paracolpi in gomma - ruote multidirezionali ø 125 mm.

EN Laundry trolleys. Stainless steel structure - laminate shelves - fireproof fabric bag included - rubber shock absorbers - multidirectional wheels ø 125 mm.

FR Chariots à linge. Structure en acier inox - dessus en stratifié - sac en tissu ignifuge inclus - butoir en caoutchouc - roues multidirectionnelles ø 125 mm.



DE Wäschereiwagen. Edelstahlstruktur - Laminatoberflächen - feuerfester Gewebesack inbegriffen - Gummistoßschutz - Mehrwegräder ø 125 mm.



NOCE/WALNUT



WENGÉ

	CA 1501 noce-walnut	CA 1505 noce-walnut	CA 1505W wengé	CA 1510 noce-walnut	CA 1510W wengé	CA 1515 noce-walnut	CA 1515W wengé
	79 x 43 x 129(h) cm	70/100 x 50 x 123(h) cm		90/143 x 50 x 123(h) cm		110/143 x 50 x 123(h) cm	
	3	4		4		4	
	-	1 bracciaio pieghevole 1 folding arm		2 braccia pieghevoli 2 folding arms		2 braccia pieghevoli 2 folding arms	
	330 €	630 €		670 €		680 €	

Carrelli portabiancheria
Laundry trolleys

OPTIONAL



CA 740



NOCE/WALNUT



CA 1525



INOX



IT Carrello portabiancheria. Struttura in acciaio inox - piani in laminato - 2 portasacchi, in dotazione un sacco in tessuto ignifugo - cassetto superiore porta accessori - paracolpi in gomma - ruote multidirezionali \varnothing 125 mm.

EN Laundry trolley. Stainless steel structure - laminate shelves - 2 bag holders, supplied with a fireproof fabric bag - upper drawer for accessories - rubber shock absorber - multidirectional wheels \varnothing 125 mm.

FR Chariot à linge. Structure en acier inox - étagères en stratifié - 2 porte-sacs, fournis avec un sac en tissu ignifugé - tiroir supérieur porte-accessoires - butoir en caoutchouc - roues multidirectionnelles \varnothing 125 mm.

DE Wäschereiwagen. Edelstahlstruktur - Laminatoberflächen - 2 Sackhalter, feuerfester Gewebesack inbegriffen - obere Schublade für Zubehörteile - Gummistoßschutz - Mehrwegräder \varnothing 125 mm.

IT Carrello portabiancheria. Struttura in acciaio inox - piani in acciaio inox - 2 portasacchi, in dotazione un sacco in tessuto ignifugo - cassetto superiore porta accessori in acciaio inox - paracolpi in gomma - ruote multidirezionali \varnothing 125 mm.

EN Laundry trolley. Stainless steel structure - stainless steel shelves - 2 bag holders, supplied with a fireproof fabric bag - stainless steel upper drawer for accessories - rubber shock absorber - multidirectional wheels \varnothing 125 mm.

FR Chariot à linge. Structure en acier inox - étagères en acier inox - 2 porte-sacs, fournis avec un sac en tissu ignifugé - tiroir supérieur porte-accessoires en acier inox - butoir en caoutchouc - roues multidirectionnelles \varnothing 125 mm.

DE Wäschereiwagen. Edelstahlstruktur - Edelstahloberflächen - 2 Sackhalter, feuerfester Gewebesack inbegriffen - obere Schublade aus Edelstahl für Zubehörteile - Gummistoßschutz - Mehrwegräder \varnothing 125 mm.

	CA 740 noce-walnut
	82/152 x 50 x 158(h) cm
	4 piani + cassetta 4 layers + upper drawers
	2 braccia pieghevoli 2 folding arms
	1.000 €

	CA 1525 inox
	75/142 x 55 x 152(h) cm
	4 piani + cassetta 4 layers + upper drawers
	2 braccia pieghevoli 2 folding arms
	1.190 €

CA 1530



IT Carrello portabiancheria, pulizia e multiuso. Struttura in lamiera verniciata a polveri epossidiche - 2 portasacchi, in dotazione un sacco in tessuto ignifugo - vaschetta porta detersivi superiore - ruote ø 140 mm, di cui 2 fisse e 2 girevoli.

EN Laundry, cleaning and multi-purpose trolley. Structure in epoxy powder coated sheet - 2 bag holders, supplied with a fireproof fabric bag - upper detergent tray - wheels ø 140 mm, 2 of which fixed and 2 swivelling.

FR Chariot à linge, nettoyage et polyvalent. Structure en tôle d'acier peinte avec des poudres époxydiques - 2 porte-sacs, fournis avec un sac en tissu ignifugé - plateau supérieur à détergent - roues ø 140 mm, dont 2 fixes et 2 pivotantes.

DE Wäscherei-, Reinigungs- und Mehrzweckwagen. Struktur aus mit Epoxidpulvern beschichtetem Blech - 2 Sackhalter, feuerfester Gewebesack inbegriffen - obere Waschmittelablage - Räder ø 140 mm, davon 2 fest und 2 schwenkbar.

	CA 1530
	80/153 x 50 x 158(h) cm
	3 piani + 2 portasacchi 3 layers + 2 bag holders
	2 braccia pieghevoli 2 folding arms
	1.310 €

Carrelli portabiancheria, pulizia e multiuso.
Laundry cleaning and multi-purpose trolleys.

Optional

A 520
CA1501 - CA1505 - CA1510 - CA1515 - CA1530 - CA740
CA1525 - CA1530

sacco in tela ignifugo
fireproof fabric bag sac
en tissu ignifugé
feuerfester Gewebesack

68 €

A 515
CA1501 - CA1505 - CA1510 - CA1515 CA1530 - CA740 - CA1525

Ruote con freno
Wheels with brake
Roues avec frein
Räder mit Bremsen

17 € cad./each

A 518
CA1530

Ruote con freno
Wheels with brake
Roues avec frein
Räder mit Bremsen



25 € cad./each

CR 1696





IT Carrello rifornimento frigo e multuso. Struttura in lamiera verniciata a polveri epossidiche - vaschetta laterale per la raccolta dei vuoti, asportabile - ruote ø 140 mm, di cui 2 fisse e 2 girevoli.

EN Multipurpose and mini bar filling trolley. Structure in epoxy powder coated plate - side tray for collecting dirt, removable - wheels ø 140 mm, of which 2 fixed and 2 swivelling.

FR Chariot pour le remplissage mini bar et polyvalent. Structure en tôle peinte à la poudre époxy - plateau latéral de vidange, démontable - roues de ø 140 mm, dont 2 fixes et 2 pivotantes.

DE Minibar- und Mehrzweckwagen. Struktur aus mit Epoxidpulvern beschichtetem Blech - seitliche Ablage zum Entleeren, abnehmbar - Räder ø 140 mm, davon 2 fest und 2 drehbar.

	CR 1696
	80 x 50 x 118(h) cm
	4 vaschette / side trays
	1.050 €

Optional

A 1001

Cestino piccolo
Small basket
Petit panier
Kleiner Korb

12 €

A 1002

Cestino grande
Large basket
Grand panier
Großer Korb

28 €

A 518

Ruote con freno
Wheels with brake
Roues avec frein
Räder mit Bremsen

25 € cad./each



CA 1696
CON OPTIONAL
WITH OPTIONAL



CA 3203

OPTIONAL A 525

Sacco a tela
Fabric bag
Sac de toile
Gewebesack

52 €



- IT Cestone portabiancheria pieghevole con sacco in tela e ruote multidirezionali.
- EN Folding laundry basket with fabric bag and multidirectional wheels.
- FR Sac à linge pliable avec sac en toile et roues multidirectionnelles.
- DE Faltbarer Wäschekorb mit Gewebesack und Mehrwegräder.

	CA 3203
	62 x 64 x 100(h) cm
	225 €

CA 1580

OPTIONAL A 521

Sacco a tela
Fabric bag
Sac de toile
Gewebesack

78 €



- IT Carrello pieghevole plastificato. Struttura in tubo e tondino di acciaio elettroverniciato - ruote multidirezionali Ø" 80 mm.
- EN Plastic-coated folding basket. Structure in electro-varnished steel tube and rod - multidirectional wheels.
- FR Corbeille pliante plastifié. Structure en tube et tige d'acier électrovernissées - roues multidirectionnelles.
- DE Faltbarer Kunststoffwäschekorb. Struktur aus elektrolackiertem Stahlrohr - Mehrwegräder.

	CA 1580
	80 x 51 x 72(h) cm
	140 €

CA 1584

OPTIONAL A 531

Sacco a tela
Fabric bag
Sac de toile
Gewebesack

82 €

CA 1584

- IT Carrello pieghevole rinforzato con struttura tubolare Ø30mm laccato -- ruote a forcella Ø 100 mm.
- EN Reinforced folding trolley with lacquered tubular structure Ø30 mm - fork wheels Ø 100 mm.
- FR Chariot pliant renforcé à structure tubulaire laquée Ø30 mm - roues à fourches Ø 100 mm.
- DE Verstärkter Klappwagen mit lackierter Rohrstruktur Ø30 mm - Gabelräder Ø 100 mm.

	CA 1584
	100 x 60 x 87(h) cm
	360 €

Cestone e carrelli con cesto per biancheria
Basket and trolleys with laundry basket

CA 1599



CA 1599E



IT Secchio carrellato con strizzatore. Struttura di rialzo per inserimento prodotti pulizia - manico cromato ad incastro con impugnatura in gomma antiscivolo.

EN Bucket with wringer on wheels. Elevated structure for the insertion of cleaning products - chromed handle with non-slip rubber grip.

FR Seau sur roues avecessoreuse. Structure de rehausse pour l'insertion des produits de nettoyage - manche chromé avec poignée antiglisse en caoutchouc.

DE Fahrbarer Mopp Eimer mit Presse. Erhöhte Struktur für den Einsatz von Reinigungsmitteln - verchromter Griff mit rutschfestem Gummigriff.

IT Secchio carrellato con strizzatore.

EN Bucket with wringer on wheels.

FR Seau sur roues avecessoreuse.

DE Fahrbarer Mopp Eimer mit Presse.

	CA 1599
	55 x 27 x 87(h) cm
	180 €

	CA 1599E
	60 x 40 x 92(h) cm
	90 €

CA 1604



A570 STRIZZATORE PLASTICA CON INGRANAGGI
IN PLASTICA- PLASTIC SQUEEZER WITH
MECHANISM

- IT Secchio carrellato con strizzatore in nylon - 2 secchi da 25 L - maniglione reversibile - ruote multidirezionali da \varnothing 80 mm.
- EN Bucket with nylon wringer on wheels - 2x25 L buckets - reversible handle - multidirectional wheels \varnothing 80 mm.
- FR Seau sur roue avecessoreuse en nylon - 2 seaux de 25 litres - poignée réversible - roues multidirectionnelles \varnothing 80 mm.
- DE Fahrbarer Mopp Eimer mit Nylonpresse - 2x25 L. Eimer - Wendegriff - Mehrwegräder \varnothing 80 mm.

CA 1604E



RC0875 SECCHIO IN PLASTICA ROSSO /RED BUCKET
RC0874 SECCHIO IN PLASTICA BLU /BLUE BUCKET
RC0876 STRIZZATORE /WRINGER

- IT Secchio carrellato con strizzatore in nylon - 2 secchi da 17 L - maniglione reversibile - ruote multidirezionali da \varnothing 80 mm.
- EN Bucket with nylon wringer on wheels - 2x17 L buckets - reversible handle - multidirectional wheels \varnothing 80 mm.
- FR Seau sur roue avecessoreuse en nylon - 2 seaux de 17 litres - poignée réversible - roues multidirectionnelles \varnothing 80 mm.
- DE Fahrbarer Mopp Eimer mit Nylonpresse - 2x17 L. Eimer - Wendegriff - Mehrwegräder \varnothing 80mm.

	CA 1604
	69 x 42 x 85(h) cm
	200 €

	CA 1604E
	71 x 43 x 93(h) cm
	160 €

CA 1613

A540 RICAMBIO MOP IN COTONE
400 GR. SPARE COTTON MOP

A550 PINZA PLASTICA GIGANTE PER MOP.
GIANT PLASTIC PINCER FOR MOP

A560 MANICO LEGNO VERNICIATO
DIAM.24 -150 Cm.
WOODEN HANDLE D. 24 -150 C



IT Carrello per pulizia. Telaio e impugnatura in plastica - secchio, strizzatore e cassette in plastica - strizzatore in plastica a libro senza fondo - portasacco da 120 L completo di rinforzi e coperchio - 2 secchielli da 4 L e 1 secchio da 28 L - gancio portapaletta e gancio portamanico con rullo in gomma.

EN Cleaning trolley Plastic frame and handle - plastic bucket, wringer and trays - plastic wringer without bottom - 120 L bag holder complete with reinforcements and lid - 2x4 L buckets and 1x28 L bucket. - dustpan hook and handle hook with rubber roller.

FR Chariot pour le nettoyage. Corps et poignée en plastique - seau, essoreuse et bacs en plastique - essoreuse en plastique sans fond - porte-sac de 120 L. complet avec renforts et couvercle - 2 seaux de 4 L. et 1 seau de 28 L. - crochet pour palette et manche avec rouleau en caoutchouc.

DE Reinigungswagen. Kunststoffrahmen und -griff - Eimer, Presse und Behälter aus Kunststoff - Kunststoffpresse ohne Boden - 120 L. Sackhalterung komplett mit Verstärkungen und Deckel - 2x4 L. Eimer und 1x28 L. Eimer - Kehrblech- und Griffhaken mit Gummirolle.

CA 1614



IT Carrello per pulizia. Telaio e impugnatura in plastica - secchio, strizzatore e cassetta in plastica media - portasacco - 2 secchielli da 4 L e 1 secchio da 15 L - ganci portascopa - ruote ø 100 mm. Il porta vaschette superiore non è incluso.

EN Cleaning trolley Plastic frame and handle - bucket, wringer and medium plastic tray - bag holder - 2 buckets of 4 L and 1 bucket of 15 L - broom hook - wheels ø 100 mm. The upper tray holder is not included.

FR Chariot pour le nettoyage. Corps et poignée en plastique - seau, essoreuse et bac moyen en plastique moyenne - porte-sac - 2 seaux de 4 L. et 1 seau de 15 L. - crochets porte balai - roues ø 100 mm. Le porte bacs supérieur n'est pas inclus.

DE Reinigungswagen. Kunststoffrahmen und -griff - Eimer, Presse und mittelgroßer Behälter aus Kunststoff - Sackhalterung - 2x4 L. Eimer und 1x15 L. Eimer - Besenhaken - Räder ø 100 mm. Der obere Ablagefachhalter ist nicht inbegriffen.

	CA 1613
	107 x 56 x 111(h) cm
	420 €

	CA 1614
	92 x 55 x 124(h) cm
	450 €

CA 1615

A540 RICAMBIO MOP IN COTONE
400 GR. SPARE COTTON MOP

A550 PINZA PLASTICA GIGANTE
PER MOP.
GIANT PLASTIC PINCER FOR MOP

A560 MANICO LEGNO
VERNICIATO
DIAM.24 -150 Cm.
WOODEN HANDLE D. 24 -150 C



IT Carrello per la pulizia. Telaio e impugnatura in plastica - secchio, strizzatore e cassetta in plastica media - portasacco - 2 secchielli da 4 L e 2 secchi da 15 L - ganci portascope - vano centrale con cassetto scorrevole - ruote ø 100 mm. Portavaschette superiore non incluso.

EN Cleaning trolley Plastic frame and handle - bucket, wringer and medium plastic tray - bag holder - 2x4 L buckets and 2x15 L buckets - broom hook - central compartment with sliding drawer - wheels ø 100 mm. The upper tray holder is not included.

FR Chariot pour le nettoyage. Corps et poignée en plastique - seau,essoreuse et bac moyen en plastique moyenne - porte-sac - 2 seaux de 4 L. et 2 seaux de 15 litres - crochets porte balai - compartiment central avec tiroir coulissant - roues ø 100 mm. Le port bacs supérieur n'est pas inclus.

DE Reinigungswagen. Kunststo rahmen und -griff - Eimer, Presse und mittelgroßer Behälter aus Kunststo - Sackhalterung - 2x4 L. Eimer und 1x15 L. Eimer - Besenhaken - Mittelfach mit Schiebeschublade - Räder ø 100 mm. Der obere Ablagefachhafter ist nicht inbegriffen.

	CA 1615
	92 x 68 x 124(h) cm
	490 €

CA 1616

Coperchio superiore di
colore blu non incluso
-Blue lid not included.





IT Carrello per la pulizia. Telaio e impugnatura in plastica - secchio, strizzatore e cassetta in plastica media - cestino portabottiglie portasacco - 4 secchielli da 4 L e 2 secchi da 15 L - ganci portascope - vano centrale con cassetto scorrevole - ruote ø 100 mm. Coperchio superiore di colore blu non incluso nel prezzo.

EN Cleaning trolley Plastic frame and handle - bucket, wringer and medium plastic tray - bottle rack - bag holder - 2x4 L buckets and 2x15 L buckets - broom hook - central compartment with sliding drawer - wheels ø 100 mm. Blue lid not included in the price.

FR Chariot pour le nettoyage. Corps et poignée en plastique - seau,essoreuse et bac moyen en plastique moyenne - corbeille pour bouteilles, porte-sac - 4 seaux de 4 L. et 2 seaux de 15 litres - crochets porte balai - compartiment central avec tiroir coulissant - roues ø 100 mm. Couvercle supérieur bleu non compris dans le prix.

DE Reinigungswagen. Kunststoffrahmen und -griff - Eimer, Presse und mittelgroßer Behälter aus Kunststoff - Flaschenkorb und Sackhalterung - 2x4 L. Eimer und 1x15 L. Eimer - Besenhaken - Mittelfach mit Schiebeschublade - Räder ø 100 mm. Blaue obere Abdeckung nicht im Preis inbegriffen.

	CA 1616
	133 x 68 x 124(h) cm
	800 €

Carrelli per pulizia
Cleaning trolleys

CA 1606E



CA 1520



IT Carrello per pulizia. Telaio e impugnatura in plastica - secchio con strizzatore in plastica - portasacco con sacco da 120 L - attacco porta utensili.

EN Cleaning trolley Plastic frame and handle - bucket with plastic wringer - bag holder with 120 L bag - tool holder.

FR Chariot pour le nettoyage. Corps et poignée en plastique - seau avec essoreuse en plastique - porte-sac avec sac de 120 L. - porte-outils.

DE Reinigungswagen. Kunststoffrahmen und -griff - Eimer mit Kunststoffpresse - Sackhalterung mit 120 L. Sack - Werkzeughalteranschluss.

IT Carrello multiuso in plastica.

EN Multi-purpose plastic trolley.

FR Multi-purpose plastic trolley.

DE Mehrzweckwagen aus Kunststoff.

	CA 1606E
	114 x 51 x 98(h) cm
	250 €

	CA 1520
	150 x 54 x 99(h) cm
	350 €





Articoli vari per la macelleria

ITEMS FOR THE MEAT PROCESSING
ARTICLES POUR
LA TRANSFORMATION DE LA VIANDE
ARTIKEL FÜR DIE FLEISCHVERARBEITUNG

LMMC



LMM



LM 48M



IT Combinato lavamani più lavastracci in acciaio inox con rubinetto acqua calda/fredda.

EN Stainless steel combi hand washer and rags washer with hot / cold water tap.

FR Lave-mains combiné en acier inox avec robinet d'eau chaude / froide.

DE Handwasch- & Ausgussbecken übereinanderliegend mit Heiß / Kaltwassermischer.

IT Lavamani con mobile e comandi a ginocchio. Lavamani in acciaio inox su mobile con porte a battente - comando a ginocchio.

EN Hand washer on neutral element with knee lever. Stainless steel hand washer on cabinet with hinged doors - knee lever.

FR Lave-mains sur meuble neutre avec commande à genou. Lave-mains en acier inox sur meuble à portes battantes - commande à genou.

DE Handwaschbecken auf Schrank mit Kniehebel. Handwaschbecken auf Schrank mit Flügeltüren - Kniehebel.

	LMMC
	70 x 50 x 89(h) cm
	760 €

	LMM	LM 48M
	50 x 40 x 85(h) cm	40 x 40 x 85(h) cm
	600 €	570 €

Lavamani
Hand washer

LC 50MM



LM 40



LM 48



LC 50



IT Lavamani e lavautensili con mobile. Lavamani e utensili su mobile in acciaio inox - porta battente - miscelatore acqua calda/fredda vasca da 40x40x25(h) cm.

EN Hand washer and tools washer on cabinet. Hand washer and tools washer on stainless steel cabinet - hinged door - hot / cold water tap, bowl 40x40x25(h) cm.

FR Lave-mains et lave-outils sur meuble. Lave-mains et lave-outils sur meuble en acier inox - porte battante - robinet d'eau chaude / froide cuve 40x40x25(h) cm.

DE Hand- und Werkzeugwaschbecken auf Schrank. Hand- und Werkzeugwaschbecken auf Edelstahlschrank - Flügeltür - 40x40x25(h) cm Heiß-/Kaltwassermischer.

IT Lavamani a colonna e comandi a ginocchio. Struttura in acciaio inox.

EN Pillar hand washer with knee lever. Stainless steel structure.

FR Colonne lave-mains avec commandes à genou. Structure en acier inox.

DE Säulenhandwaschbecken mit Kniehebel. Edelstahlstruktur.

	LC 50MM
	50 x 50 x 85(h) cm
	800 €

	LM 40	LM 48	LC 50
	40 x 40 x 32(h) cm	48 x 35 x 53(h) cm	50 x 40 x 80(h) cm
	280 €	390 €	390 €

SUV 10

SUV 14

SN 38



IT Armadietto sterilizzatore a raggi UV costruito in acciaio inox AISI 304 Scotch Brite. Portina in plexiglas trasparente con microinterruttore - portacoltelli in acciaio inox - funzionamento con lampada germicida con griglia di protezione temporizzatore 60' e lampada spia di funzionamento - cavo con spina.

EN UV sterilizer cabinet made of Scotch Brite stainless steel AISI 304. Clear Plexiglas door with microswitch - stainless steel knife holder - operation with germicidal lamp with 60' timer protection grid and indicator lamp - cable with plug.

FR Armoire stérilisateur UV en acier inox Scotch Brite AISI 304. Porte en plexiglas transparent avec microinterrupteur - porte-couteau en acier inox - fonctionnement avec lampe germicide avec grille de protection, minuteur 60' et indicateur lumineux - câble avec fiche.





DE UV-Sterilisationsschrank aus Scotch Brite Edelstahl AISI 304. Tür aus klarem Plexiglas mit Mikroschalter - Messerhalter aus Edelstahl - Betrieb mit Keimtöterlampe mit 60' Timer, Schutzgitter und Anzeigelampe - Kabel mit Stecker.

IT Sterilizzatori elettrici per coltelli. Struttura in acciaio inox - termostato regolabile interno +30 +110°C - rubinetto di carico e scarico.

EN Electric knives sterilizers Stainless steel structure - internal adjustable thermostat +30 +110°C - filling and emptying tap.

FR Stérilisateur électriques pour couteaux. Structure en acier inox - thermostat interne réglable +30 +110°C - robinet de remplissage et de vidange.

DE Elektrische Sterilisatoren für Messer. Edelstahlstruktur - innenliegender einstellbarer Thermostat +30 +110°C - Be- und Entladehahn.

	SUV 10	SUV 14
	16 W	
 1 Ph	230 V 50/60 HZ	
	N° 10 coltelli - knives	N° 14 coltelli - knives
 cm	43 x 16 x 64(h) cm	54 x 16 x 64(h) cm
	385 €	415 €

	SN 38
	1500 W
 1 Ph	230 V 50/60 HZ
	N° 12 coltelli - knives
 cm	38 x 14 x 40(h) cm
	385 €

Sterilizzatori
Sterilizers

ANTINFORTUNISTICA PER MACELLERIA

AV 4897 - AV 4898
AV 4900 - AV 4901

i	AV 4897
1	<p>Grebiule alluminio antinfortunistico con bretelle Aluminium safety apron with shoulder straps Tablier de sécurité en aluminium avec sangles d'épaule Aluminium Sicherheitsschürze mit Schultergurten</p>
	220 €

i	AV4901
4	<p>Guanto inox antinfortunistico a cinque dita con chiusura a molla inox. Avambraccio compreso Stainless steel five finger safety glove with stainless steel spring fastening. Forearm included. Gant de sécurité à cinq doigts en acier inox avec fermeture à ressort en acier inox. Avant-bras inclus. Edelstahl-Fünf-Finger-Sicherheitshandschuh mit Edelstahl-Feder-Verschluss. Unterarm inklusive.</p>
	290 €

i	AV 4898
2	<p>Grebiule acciaio inox antinfortunistico con bretelle Stainless steel safety apron with shoulder straps Tablier de sécurité en acier inox avec sangles d'épaule Edelstahl-Sicherheitsschürze mit Schultergurten</p>
	210 €

i	AV4900
3	<p>Guanto inox antinfortunistico a cinque dita con cinturino inox completamente sterilizzabile Five-finger stainless steel safety glove with stainless steel strap, fully sterilisable Gant de sécurité à cinq doigts en acier inox avec sangle en acier inox, entièrement stérilisable Edelstahl-Fünf-Finger-Sicherheitshandschuh mit Edelstahlband völlig sterilisierbar</p>
	165 €



CCL

IT Ceppo in legno di acacia e sgabello. Ceppo trattato con vernice atossica e collanti ecologici (conformi alle norme vigenti) assemblato con innesti a pressione e internamente con inserti speciali in legno - batticarne ecologico e riciclabile - reversibile.

EN Acacia wood chopping block and stool. Chopping block treated with non-toxic paint and ecological adhesives (in compliance with current standards) assembled with pressure joints and internally with special wood inserts - ecological and recyclable meat beater - reversible.

FR Blocs de boucher en bois d'acacia et tabouret. Bloc traité avec peinture atoxique et adhésifs écologiques (conformes aux normes en vigueur) assemblés avec embrayages à pression et intérieur avec inserts spéciaux en bois - bloc à viande écologique et recyclable - réversible.

DE Metzger-Block aus Akazienholz und Hocker. Metzger-Block behandelt mit ungiftiger Farbe und ökologischen Klebstoffen (nach den gültigen Normen), zusammengebaut mit Steckverbindungen und speziellen innen Holzeinsätzen - umweltfreundlicher und wiederverwertbarer Fleischklopper - beidseitig.



	CCL 1744	CCL 1745	CCL 1755	CCL 1764	CCL 1766	CCL 1774	CCL 1775
	40 x 40 x 90(h) cm	45 x 45 x 90(h) cm	50 x 50 x 90(h) cm	60 x 40 x 90(h) cm	60 x 60 x 90(h) cm	70 x 40 x 90(h) cm	70 x 50 x 90(h) cm
	580 €	640 €	750 €	750 €	1.000 €	830 €	1.000 €



SPESSORE / THICKNESS 17 cm

	CCL 2544	CCL 2555	CCL 2564	CCL 2566	CCL 2574	CCL 2575	CCL 2577
	40 x 40 x 90(h) cm	50 x 50 x 90(h) cm	60 x 40 x 90(h) cm	60 x 60 x 90(h) cm	70 x 40 x 90(h) cm	70 x 50 x 90(h) cm	70 x 70 x 90(h) cm
	725 €	935 €	935 €	1.150 €	990 €	1.150 €	1.370 €



SPESSORE / THICKNESS 25 cm

	CCL 3555	CCL 3566	CCL 3575	CCL 3577	CCL 3586
	50 x 50 x 90(h) cm	60 x 60 x 90(h) cm	70 x 50 x 90(h) cm	70 x 70 x 90(h) cm	80 x 60 x 90(h) cm
	1.150 €	1.430 €	1.430 €	1.775 €	1.775 €



SPESSORE / THICKNESS 35 cm

Ceppi
Butcher blocks

CCP

IT Ceppo in polietilene e sgabello in acciaio inox **AISI 304**.

EN Polyethylene block and **AISI 304** stainless steel stool.

FR Bloc en polyéthylène et tabouret en acier inox **AISI 304**.

DE Polyethylenblock und Hocker aus Edelstahl **AISI 304**.



	CCP 8000	CCP 8001	CCP 8002	CCP 8003
	40 x 40 x 88(h) cm	50 x 50 x 88(h) cm	70 x 50 x 88(h) cm	60 x 60 x 88(h) cm
	490 €	600 €	680 €	730 €

	CCP 8004	CCP 8005	CCP 8006
	70 x 70 x 88(h) cm	80 x 60 x 88(h) cm	100 x 50 x 88(h) cm
	880 €	805 €	850 €

KCP

IT Copriceppo di polietilene bianco.

EN White polyethylene block cover.

FR Couverture en polyéthylène blanc.

DE Weiße Polyethylenabdeckung.



	KCP 2501	KCP 2502	KCP 2503	KCP 2504
	40 x 40 x 2,5(h) cm	50 x 50 x 2,5(h) cm	60 x 40 x 2,5(h) cm	60 x 60 x 2,5(h) cm
	96 €	145 €	140 €	190 €

	KCP 2505	KCP 2506	KCP 2508
	70 x 40 x 2,5(h) cm	70 x 50 x 2,5(h) cm	70 x 70 x 2,5(h) cm
	155 €	190 €	250 €

CPE

IT Ceppo di polietilene alimentare bianco.

EN Chopping block made of white food grade polyethylene.

FR Bloc en polyéthylène alimentaire.

DE Polyethylenblock.



	CPE 40408	CPE 50508	CPE 70508	CPE 60608
	40 x 40 x 8(h) cm	50 x 50 x 8(h) cm	70 x 50 x 8(h) cm	60 x 60 x 8(h) cm
	210 €	300 €	370 €	400 €

	CPE 70708	CPE 80608	CPE 100508
	70 x 70 x 8(h) cm	80 x 60 x 8(h) cm	100 x 50 x 8(h) cm
	520 €	470 €	470 €

TP

IT Taglieri in polietilene. Colore bianco.

EN Polyethylene cutting boards. Colour: white.

FR Planches à découper en polyéthylène. Couleur blanche.

DE Schneidbretter aus Polyethylen. Farbe: weiß.



GIALLO/YELLOW



MARRONE/BROWN



VERDE/GREEN



BLU/BLUE



ROSSO/RED

Per scelta colore aggiungere al codice:

For colour choice add to code:

Pour choisir la couleur, ajoutez au code:

Fügen Sie für die Farbauswahl den Code hinzu:

Y = Giallo / Yellow / Gelb / Jaune

M = Marrone / Brown / Braun / Marron

G = Verde / Green / Grün / Vert

B = Blu / Blue / Blau / Bleu

R = Rosso / Red / Rot / Rouge

RASK - RICRA

IT **RASK:** Raschietto per pulizia ceppi e taglieri compreso di 4 lamette.

EN **RASK:** Scraper for butcher blocks and cutting boards cleaning.
RICRA: Spare blade for scraper

FR **RASK:** Racloir pour le nettoyage des blocs et des planches à découper.
RICRA: Lame de rechange pour racloir

DE **RASK:** Schaber zum Reinigen von Metzger-Blöcke und Schneidbrettern.
RICRA: Ersatzklinge für Schaber.



RASK

	RASK
	46 €

	TP 40302	TP 50302	TP 50402	TP 60402
	40 x 30 x 2(h) cm	50 x 30 x 2(h) cm	50 x 40 x 2(h) cm	60 x 40 x 2(h) cm
	46 €	46 €	46 €	73 €

	TP 70402	TP 80402	TP 50302	TP 60402
	70 x 40 x 2(h) cm	80 x 40 x 2(h) cm	50 x 30 x 2(h) cm Y/M/G/B/R	60 x 40 x 2(h) cm Y/M/G/B/R
	85 €	91 €	46 €	73 €

Taglieri e raschietto
Cutting boards and scraper

Scaffalatura modulare

Modular shelving



IT Scaffalatura modulare in alluminio anodizzato. Design rispondente alle norme igieniche con superfici lisce ed arrotondate, profili chiusi e totale assenza di spazi o fessure - leghe di alta qualità resistenti all'usura prodotta da agenti chimici, termici e meccanici - ampia scelta di misure - possibilità di inserimento vaschette serie Gastronorm GN1/2-GN1/1-GN2/1-GN2/3 inserite all'interno dei ripiani.

EN Modular shelving in anodized aluminium. Design in compliance with hygiene standards with smooth and rounded surfaces, closed profiles and total absence of spaces or gaps - high quality alloys resistant to wear produced by chemical, thermal and mechanical agents - wide choice of sizes - possibility of inserting Gastronorm containers GN1/2-GN1/1-GN2/1-GN2/3 inside the shelves.

FR Rayonnage modulaire en aluminium anodisé. Design hygiénique avec des surfaces lisses et arrondies, des profilés fermés et absence totale d'espaces ou de fissures - alliages de haute qualité résistants à l'usure par des agents chimiques, thermiques et mécaniques - large choix de dimensions - possibilité d'insérer des bacs Gastronorm GN1/2-GN1/1-GN2/1-GN2/3 dans les étagères.

DE Modulare Regale aus eloxiertem Aluminium. Design nach Hygienestandards mit glatten und abgerundeten Oberflächen, geschlossenen Profilen und völliger Abwesenheit von Zwischenräumen oder Rissen - hochwertige, verschleißfeste Legierungen gegen chemischen, thermischen und mechanischen Werkstoffen - umfangreiche Größenauswahl - Behältern der Serie Gastronorm GN1/2-GN1/1-GN2/1-GN2/1-GN2/3, in den Regalen einsetzbar.

IT Ripiani in alluminio completi di griglie in polietilene. Composti da: 2 fiancate, 4 attacchi, serie griglie.

EN Aluminium shelves complete with polyethylene grids. Composed of: 2 sides, 4 brackets, grids.

FR Étagères en aluminium complètes avec des grilles en polyéthylène. Composé de: 2 côtés, 4 supports, série de grilles.

DE Aluminiumzwischenetagen komplett mit Polyethylen-Gittern. Bestehend aus: 2 Seitenpaneele, 4 Halterungen, Gittern.

i	R62	R88	R97	R106
	Max. 240 kg	Max. 180 kg	Max. 170 kg	Max. 150 kg
↗ cm	37,3 x 62 cm	37,3 x 88,6 cm	37,3 x 97,4 cm	37,3 x 106,2 cm
	70 €	78 €	82 €	85 €

i	R115	R124	R133	R150
	Max. 140 kg	Max. 130 kg	Max. 110 kg	Max. 90 kg
↗ cm	37,3 x 115,2 cm	37,3 x 124 cm	37,3 x 133 cm	37,3 x 150,5 cm
	95 €	105 €	110 €	120 €

IT Testata in alluminio completa di: 2 piantane, 3 traversini, 2 piedi e 2 tappi.

EN Stainless steel front panel. Complete with: 2 pillars, 3 crosspieces, 2 feet and 2 plugs.

FR Façade en aluminium. Complète avec: 2 montants, 3 traverses, 2 pieds et 2 capuchons

DE Edelstahlfrontblende. Komplett mit: 2 Träger, 3 Querstäbe, 2 Füße und 2 Kappen.

Giunzioni per angolo.
Corner joints.
Joints de coin.
Eckverbindungen.

i	F15	F17	F20	GA373
↗ cm	37,3 x 155(h) cm	37,3 x 170(h) cm	37,3 x 200(h) cm	37,3 cm
	110 €	110 €	120 €	26 €

SE30



FT30

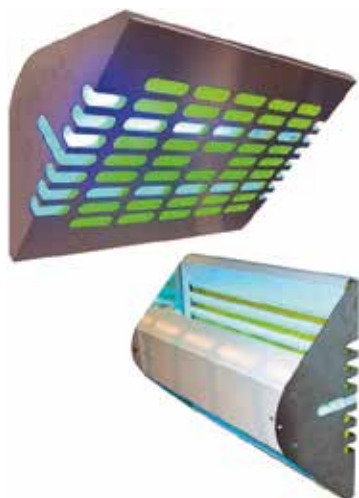

PZ30N



- IT Elettroinsetticidi a lampade UVA. Materiale alluminio. Potenza 30W.
Lampade 2x15W - possibilità di montaggio in orizzontale o verticale -
copertura fino a 80 mq.
- EN Electro-insecticides with UVA lamps. Material: Aluminium Power 30W.
2x15W lamps - horizontal or vertical installation - surface cover up to 80
sqm.
- FR Electro-insecticides avec lampes UVA. Matériel : aluminium. Puissance 30W.
2 Lampes 15W - possibilité de montage horizontal ou vertical - portée ju-
squ'à 80 m².
- DE Elektroinsekt-Killer mit UVA-Lampen. Material: Aluminium. Leistung 30W.
2x15W Lampen - horizontale oder vertikale Montage möglich - Reichweite
bis zu 80 qm.

i	SE30	FT30	PZ30N
↗ cm	32 x 14 x 54(h) cm	48 x 36 x 16(h) cm	55 x 11 x 26(h) cm
	245 €	270 €	140 €

Optional

CRS30 SE30	CR30 FT30
Collante di ricambio confezione da 6 pezzi Spare glue pack of 6 pieces Colle de rechange 6 pièces Ersatzkleber 6 Stück-Packung	
40 €	54 €
L617 PZ30N -FT30-SE30	
Lampada da 15 W 15 W lamp Lampe 15 W 15 W Lampe	
12 €	

Elettroinsetticidi
Electro-insecticides



Attrezzatura per la colazione

BREAKFAST EQUIPMENT
ÉQUIPEMENT DE PETIT-DÉJEUNER
FRÜHSTÜCKSAUSRÜSTUNG

CD 7905



CD 9801



IT Chafing dish con coperchio. Struttura rettangolare in acciaio inox - bruciatori ad alcool.

IT Chafing dish con coperchio roll top. Struttura in acciaio inox lucido - bruciatori ad alcool.

EN Chafing dish with lid. Rectangular stainless steel casing - alcohol burners.

EN Chafing dish with roll top lid. Rectangular polished stainless steel casing - alcohol burners.

FR Chafing Dish avec couvercle. Corps rectangulaire en acier inox - Brûleurs à alcool.

FR Chafing Dish avec couvercle supérieur roll top. Corps rectangulaire en acier inox poli - Brûleurs à alcool.

DE Chafing Dish mit Deckel. Rechteckige Edelstahlstruktur - Alkohol-Brenner.

DE Chafing Dish mit Roll-Top Deckel. Rechteckige polierte Edelstahlstruktur - Alkohol-Brenner.

	CD 7905
	67 x 37 x 41(h) cm - 8,5 L
	120 €

	CD 9801
	65 x 47 x 45(h) cm - 8,5 L
	280 €

CD 6502



CD 6504



IT Chafing dish con coperchio roll top 180°. Struttura in acciaio inox lucido - bruciatori ad alcool.

EN Chafing dish with roll top lid 180°. Rectangular polished stainless steel casing - alcohol burners.

FR Chafing Dish avec couvercle supérieur roll top 180°. Corps rectangulaire en acier inox poli - Brûleurs à alcool.

DE Chafing Dish mit 180° Roll-Top Deckel. Rechteckige polierte Edelstahlstruktur - Alkohol-Brenner.

IT Chafing dish tondo con coperchio roll top 180°. Struttura in acciaio inox lucido - bruciatori ad alcool.

EN Round Chafing dish with roll top lid 180°. Rectangular polished stainless steel casing - alcohol burners.

FR Chafing Dish ronde avec couvercle supérieur roll top 180°. Corps rectangulaire en acier inox poli - Brûleurs à alcool.

DE Rundes Chafing Dish mit 180° Roll-Top Deckel. Rechteckige polierte Edelstahlstruktur - Alkohol-Brenner.

	CD 6502
	65 x 47 x 45 (h) cm - 8,5 L
	520 €

	CD 6504
	50 x 52 x 45 (h) cm - 6 L
	485 €

CD 6505



- IT Chafing dish con coperchio roll top 180° e pentole da 4,6 L. Struttura in acciaio inox lucido - bruciatori ad alcool.
- EN Chafing dish with roll top lid 180° and 4,6 L pans. Rectangular polished stainless steel casing - alcohol burners.
- FR Chafing Dish avec couvercle supérieur roll top 180° t marmites de 4,6 L. Corps rectangulaire en acier inox poli - Brûleurs à alcool.
- DE Chafing Dish mit 180° Roll-Top Deckel und 4,6 L. Töpfe. Rechteckige polierte Edelstahlstruktur - Alkohol-Brenner.

	CD 6505
	65 x 47 x 45 (h) cm
	620 €

Optional

AV9516

CD 7905 - CD 9801 - CD 6502 - CD 6504 - CD 6505

Elemento di riscaldamento elettrico per Chafing Dishes 230 V 50/60 Hz 360 W.

Electric heating element for Chafing Dishes 230 V 50/60 Hz 360 W.

Élément électrique de chauffage pour Chafing Dishes 230 V 50/60 Hz 360 W.

Elektrischer Heizelement für Chafing Dishes 230 V 50/60 Hz 360 W.

115 €

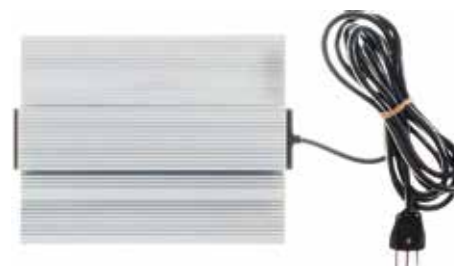

AV9517
DC10502

Elemento elettrico riscaldante 180 W. Per DC 10502

Electric heating element 180 W. For DC 10502

Élément électrique chauffant 180 W. Pour DC 10502

Elektrischer Heizelement 180 W. Für DC 10502

100 €



B 8001



DC 10502



IT Zuppiera elettrica. Corpo in alluminio verniciato - contenitore e coperchio in acciaio inox.

EN Electric soup tureen. Painted aluminium casing - stainless steel container and lid.

FR Soupière électrique. Corps en aluminium peint - récipient et couvercle en acier inox.

DE Elektrische Terrine. Gehäuse aus lackiertem Aluminium - Behälter und Deckel aus Edelstahl.

IT Distributore caldo per caffè. Struttura in acciaio inox - bruciatore ad alcool.

EN Hot coffee dispenser. Stainless steel casing - alcohol burner.

FR Distributeur de café chaud. Corps en acier inox poli - Brûleurs à alcool.

DE Heißkaffeespender. Gehäuse aus Edelstahl - Alkohol-Brenner.

	B 8001
	230 V 230 V 50Hz - 360 W
	ø 35 x 36(h) cm
	10 L
	270 €

	DC 10502
	33 x 24 x 54(h) cm
	9 L
	320 €

 156 Zuppiera elettrica
Electric soup tureen

Distributori caffè, bevande e cereali
Coffee, drinks and cereals dispensers

DCN 1706



DS 10401



DS 10402



IT Distributore caldo per caffè. Struttura in ABS con copertura in acciaio inox - dotato di termica di sicurezza - temperatura 90°C.

EN Hot coffee dispenser. ABS structure with stainless steel cover - equipped with safety thermic - temperature 90 ° C.

FR Distributeur de café chaud. Corps en ABS avec couvercle en acier inox - équipée d'un thermique de sécurité - température 90°C.

DE Heißkaffespender. ABS-Gehäuse mit Edelstahlabdeckung - ausgestattet mit Sicherheitsthermik - Temperatur 90 ° C

IT Distributore bevande. Contenitore trasparente - tubo centrale per contenimento ghiaccio.

EN Beverage dispenser. Clear container - central tube for ice filling.

FR Distributeur de boissons. Récipient transparent - tube central pour contenir de la glace.

DE Getränkespender. Klarer Behälter - Zentralrohr für die Eiseinführung.

	DCN 1706
	230 V 50Hz- 1100 W
	ø 29 x 44(h) cm
	7 L (40 tazzine - cup)
	210 €

	DS 10401	DS 10402
	27 x 22 x 58(h) cm	32 x 32 x 58(h) cm
	8 L	5 + 5 L
	260 €	480 €

DC 10301

DC 10302



IT Distributore per cereali. Contenitori trasparenti, singoli o doppi.

EN Cereals dispenser. Clear containers, single or double.

FR Distributeur de céréales. Récipients transparents, simples ou doubles.

DE Müslispender. Transparente Behälter, einfach oder doppelt.

	DC 10301	DC 10302
	36 x 26 x 66(h) cm	48 x 26 x 66(h) cm
	8 L	8 + 8 L
	200 €	420 €

AV 4561

IT Fornello flambé a gas in rame con griglia in acciaio inox.

EN Copper gas flambé cooker with stainless steel grid.

FR Cuisinière flambée à gaz en cuivre avec grille en acier inox.

DE Flambé Gasherd aus Kupfer mit Edelstahlgitter.



	AV 4561
	ø 26 x 29,5(h) cm
	460 €

Fornello Flambé
Flambé cooker

AV 4580 - AV 4581

IT Padella flambé inox-cuprum, manico legno.

EN Flambé pan stainless steel-cuprum, wooden handle.

FR Poêle flambée en acier inox-cuprum, manche en bois.

DE Flambé Cuprum-Pfanne aus Edelstahl mit Holzgriff.



	AV 4580	AV 4581
	ø 29 cm	ø 26 cm
	180 €	140 €

Padella Flambé
Flambé pan









Articoli vari



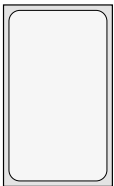
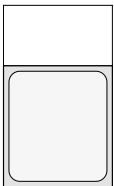

per cucina e pizzeria

ITEMS FOR COOKING AND PIZZERIA
ARTICLES POUR LA CUISINE
ET POUR LA PIZZERIA
KÜCHE- UND PIZZERIA-ARTIKEL



BACINELLE - CONTAINERS BASSINES - BEHÄLTER					
MOD. 2/1 Est. 646 x 530 mm Int. 620 x 500 mm 	GNI 21200	20(h) cm	60 L	150 €	
	GNI 21150	15(h) cm	44,9 L	130 €	
	GNI 21100	10(h) cm	31,5 L	96 €	
	GNI 2165	6,5(h) cm	18,9 L	76 €	
	GNI 2140	4(h) cm	12 L	70 €	
	GNI 2120	2(h) cm	6,5 L	67 €	
	GRI 21	Griglia - Grill			60 €
MOD. 1/1 Est. 530 x 325 mm Int. 500 x 300 mm 	GNI 11200	20(h) cm	30 L	81 €	
	GNI 11150	15(h) cm	20,6 L	70 €	
	GNI 11100	10(h) cm	13,3 L	50 €	
	GNI 1165	6,5(h) cm	8,5 L	38 €	
	GNI 1140	4(h) cm	5,5 L	34 €	
	GNI 1120	2(h) cm	2,5 L	29 €	
	COPI 11	Coperchio Lid			32 €
	COPG 11	Coperchio a tenuta Leak-proof lid			76 €
	FFF 11	Falso fondo forato Perforated false bottom			29 €
	GRI 11	Griglia - Grill			38 €
S 530	Separatore Divider			11 €	
MOD. 2/3 Est. 352 x 325 mm Int. 329 x 300 mm 	GNI 23200	20(h) cm	19,3 L	68 €	
	GNI 23150	15(h) cm	13,6 L	57 €	
	GNI 23100	10(h) cm	8,9 L	36 €	
	GNI 2365	6,5(h) cm	5,5 L	27 €	
	GNI 2340	4(h) cm	3,5 L	25 €	
	GNI 2320	2(h) cm	1,8 L	22 €	
	COPI 23	Coperchio Lid			21 €
	COPG 23	Coperchio a tenuta Leak-proof lid			62 €
	FFF 23	Falso fondo forato Perforated false bottom			24 €
	GRI 23	Griglia - Grill			30 €

ACCIAIO INOX AISI 304 S/STEEL AISI 304

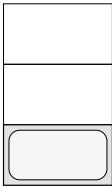
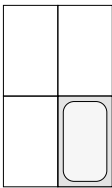

BACINELLE - CONTAINERS BASSINES - BEHÄLTER					
MOD. 1/2 Est. 325 x 265 Int. 300 x 238 	GNI 12200	20(h) cm	11,6 L	53 €	
	GNI 12150	15(h) cm	9,9 L	41 €	
	GNI 12100	10(h) cm	8 L	29 €	
	GNI 1265	6,5(h) cm	4,2 L	22 €	
	GNI 1240	4(h) cm	2,5 L	19 €	
	GNI 1220	2(h) cm	1,2 L	16 €	
	COPI 12	Coperchio Lid		18 €	
	COPG 12	Coperchio a tenuta Leak-proof lid		55 €	
	FFF 12	Falso fondo forato Perforated false bottom		16 €	
	S 325	Separatore Divider		8 €	
MOD. 1/3 Est. 325 x 176 Int. 300 x 150 	GNI 13200	20(h) cm	8,1 L	44 €	
	GNI 13150	15(h) cm	5,9 L	33 €	
	GNI 13100	10(h) cm	3,8 L	22 €	
	GNI 1365	6,5(h) cm	2,5 L	19 €	
	GNI 1340	4(h) cm	1,5 L	16 €	
	GNI 1320	2(h) cm	0,7 L	14 €	
	COPI 13	Coperchio Lid		13 €	
	COPG 13	Coperchio a tenuta Leak-proof lid		46 €	
	FFF 13	Falso fondo forato Perforated false bottom		13 €	
MOD. 1/4 Est. 265 x 162 INT. 238 x 136 	GNI 14200	20(h) cm	4,9 L	36 €	
	GNI 14150	15(h) cm	4,1 L	28 €	
	GNI 14100	10(h) cm	2,5 L	20 €	
	GNI 1465	6,5(h) cm	1,9 L	16 €	
	GNI 1440	4(h) cm	1 L	15 €	
	GNI 1420	2(h) cm	0,5 L	12 €	
	COPI 14	Coperchio Lid		11 €	
	COPG 14	Coperchio a tenuta Leak-proof lid		40 €	
	S 265	Separatore Divider		8 €	

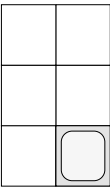
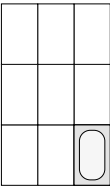

BACINELLE - CONTAINERS BASSINES - BEHÄLTER					
MOD. 1/6 Est. 176 x 162 Int. 140 x 153		GNI 16200	20(h) cm	3 L	39 €
		GNI 16150	15(h) cm	2,5 L	25 €
		GNI 16100	10(h) cm	1,6 L	17 €
		GNI 1665	6,5(h) cm	1,1 L	14 €
		COPI 16	Coperchio Lid		9 €
		COPG 16	Coperchio a tenuta Leak-proof lid		42 €
MOD. 1/9 Est. 176 x 108 Int. 140 x 100		GNI 19100	10(h) cm	0,9 L	18 €
		GNI 1965	6,5(h) cm	0,5 L	13 €
		COPI 19	Coperchio Lid		8 €









ATTENZIONE i coperchi a tenuta possono essere applicati solo su bacinelle GN con H mm. 100, 150 e 200

ATTENTION the leak-proof lids can only be applied to GN basins with H 100, 150 and 200 mm.







ATTENTION les couvercles anti-fuite ne peuvent être appliqués que sur des bassines GN avec H 100, 150 et 200 mm.

ACHTUNG Die versiegelten Deckel können nur bei GN-Behältern mit H 100, 150 und 200mm eingesetzt werden.



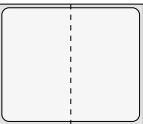

ACCIAIO INOX AISI 304 S/STEEL AISI 304

BACINELLE FORATE - PIERCED BASINS CUVETTES PERCÉES - LOCHSCHALE					
MOD. 2/1 Est. 646 x 530 mm Int. 620 x 500 mm		GNT 21200	20(h) cm	60 L	202 €
		GNT 21150	15(h) cm	44,9 L	169 €
		GNT 21100	10(h) cm	31,5 L	123 €
		GNT 2165	6,5(h) cm	18,9 L	114 €
MOD. 1/1 Est. 530 x 325 Int. 500 x 300		GNT 11200	20(h) cm	30 L	98 €
		GNT 11150	15(h) cm	20,6 L	83 €
		GNT 11100	10(h) cm	13,3 L	55 €
		GNT 1165	6,5(h) cm	8,5 L	49 €
MOD. 2/3 Est. 352 x 325 Int. 329 x 300		GNT 23200	20(h) cm	19,3 L	77 €
		GNT 23150	15(h) cm	13,6 L	65 €
		GNT 23100	10(h) cm	8,9 L	42 €
		GNT 2365	6,5(h) cm	5,5 L	39 €
MOD. 1/2 Est. 325 x 265 Int. 300 x 238		GNT 12200	20(h) cm	11,6 L	61 €
		GNT 12150	15(h) cm	9,9 L	49 €
		GNT 12100	10(h) cm	8 L	38 €
		GNT 1265	6,5(h) cm	4,2 L	25 €





TEGLIE CON FONDO FORATO TRAYS WITH PERFORATED BOTTOM					
MOD. 2/1 Est. 646 x 530 mm Int. 620 x 500 mm		GNF 2120	2(h) cm	6,5 L	80 €
		GNF 2140	4(h) cm	12 L	83 €
		GNF 2165	6,5(h) cm	18,9 L	84 €
MOD. 1/1 Est. 530 x 325 Int. 500 x 300		GNF 1120	2(h) cm	2,5 L	33 €
		GNF 1140	4(h) cm	5,5 L	37 €
		GNF 1165	6,5(h) cm	8,5 L	40 €
MOD. 2/3 Est. 352 x 325 Int. 329 x 300		GNF 2320	2(h) cm	1,8 L	25 €
		GNF 2340	4(h) cm	3,5 L	28 €
		GNF 2365	6,5(h) cm	5,5 L	30 €
MOD. 1/2 Est. 325 x 265 Int. 300 x 238		GNF 1220	2(h) cm	1,2 L	19 €
		GNF 1240	4(h) cm	2,5 L	21 €
		GNF 1265	6,5(h) cm	4,2 L	25 €





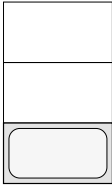
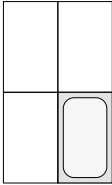
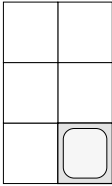
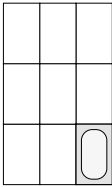

BACINELLE GN IN POLICARBONATO GN POLYCARBONATE CONTAINERS					
MOD. 1/1 Est. 530 x 325 Int. 500 x 300		GNP 11200	20(h) cm	30 L	38 €
		GNP 11150	15(h) cm	20,6 L	30 €
		GNP 11100	10(h) cm	13,3 L	25 €
		GNP 1165	6,5(h) cm	8,5 L	20 €
		COPP 11	53 x 32,5 cm	-	16 €
		GFP 11	46 x 25,5 cm	-	10 €
MOD. 1/2 Est. 325 x 265 Int. 300 x 238		GNP 12200	20(h) cm	11,6 L	18 €
		GNP 12150	15(h) cm	9,9 L	15 €
		GNP 12100	10(h) cm	8 L	12 €
		GNP 1265	6,5(h) cm	4,2 L	10 €
		COPP 12	32,5 x 26,5 cm	-	9 €
		GFP 12	25 x 19 cm	-	8 €





BACINELLE GN IN POLICARBONATO GN POLYCARBONATE CONTAINERS					
MOD. 1/3 Est. 325 x 176 Int. 300 x 150		GNP 13200	20(h) cm	8,1 L	15 €
		GNP 13150	15(h) cm	5,9 L	12 €
		GNP 13100	10(h) cm	3,8 L	10 €
		GNP 1365	6,5(h) cm	2,5 L	8 €
		COPP 13	32,5 x 17,6 cm	-	7 €
		GFP 13	25 x 11 cm	-	5 €
MOD. 1/4 Est. 265 x 162 INT. 238 x 136		GNP 14200	20(h) cm	4,9 L	13 €
		GNP 14150	15(h) cm	4,1 L	10 €
		GNP 14100	10(h) cm	2,5 L	8 €
		GNP 1465	6,5(h) cm	1,9 L	7 €
		COPP 14	26,5 x 16,2 cm	-	5 €
		GFP 14	21 x 11 cm	-	5 €
MOD. 1/6 Est. 176 x 162 Int. 140 x 153		GNP 16200	20(h) cm	3 L	10 €
		GNP 16150	15(h) cm	2,5 L	8 €
		GNP 16100	10(h) cm	1,6 L	7 €
		GNP 1665	6,5(h) cm	1,1 L	5 €
		COPP 16	17,6 x 16,2 cm	-	4 €
		GFP 16	11,5 x 10 cm	-	4 €
MOD. 1/9 Est. 176 x 108 Int. 140 x 100		GNP 19100	10(h) cm	0,9 L	6 €
		GNP 1965	6,5(h) cm	0,5 L	5 €
		COPP 19	17,6 x 10 cm	-	4 €





VASCHE PER GELATO ICE CREAM CONTAINERS				
	VG 261612	26 x 16,5 x 12(h) cm	3,5 L	31 €
	VG 261615	26 x 16,5 x 15(h) cm	4 L	38 €
	VG 33168	33 x 16,5 x 8(h) cm	3,5 L	30 €
	VG 331612	33 x 16,5 x 12(h) cm	5 L	38 €
	VG 331615	33 x 16,5 x 15(h) cm	6,5 L	39 €
	VG 36168	36 x 16,5 x 8(h) cm	4 L	29 €
	VG 361612	36 x 16,5 x 12(h) cm	5,4 L	36 €
	VG 361615	36 x 16,5 x 15(h) cm	7 L	40 €
	VG 361618	36 x 16,5 x 18(h) cm	9 L	45 €
	VG 36258	36 x 25 x 8(h) cm	5 L	34 €
	VG 362512	36 x 25 x 12(h) cm	8 L	36 €
	CR ø 200 H 250	Pozzetto inox per gelato Stainless steel ice-cream bowl		FP - OUT OF PRODUCTION



TEGLIE SMALTATE ENAMELLED TRAYS GN1/1			
	GNS 1120	GN1/1 20(h) cm	31 €
	GNS 1140	GN1/1 40(h) cm	33 €
	GNS 1165	GN1/1 65(h) cm	34 €

COPERCHI IN PLASTICA PLASTIC LIDS			
	CP 2	26,5 x 16 cm	11 €
	CP 3	33 x 16,5 cm	13 €
	CP 4	36 x 16,5 cm	15 €

SPATOLA - SPATULA			
	SPG	trasparente, rossa, blu, gialla Manico 26 cm.a Clear, red, blue, yellow Handle 26 cm	10 €

AV4510



- IT Morsa per prosciutto. Corpo in acciaio inox - supporto e manici in legno pregiato.
- EN Ham stand. Stainless steel structure - support and handles in fine wood.
- FR Serre-jambon. Corps en acier inox - support et poignées en bois de haute qualité.
- DE Schinkengriff. Edelstahlkörper - Stütze und Griffe aus edlem Holz.

	AV4510
	58 x 25 x 19(h) cm
	160 €

AV4515



- IT Morsa per prosciutto. Corpo in acciaio - supporto e manici in legno.
- EN Ham stand. Stainless steel structure - support and handles in fine wood.
- FR Serre-jambon. Corps en acier - support et poignées en bois.
- DE Schinkengriff. Edelstahlkörper - Stütze und Griffe aus edlem Holz.

	AV4515
	58 x 25 x 19(h) cm
	70 €

AV4500

- IT Apriscatole da banco. Struttura in acciaio cementato - coltello in acciaio inox - alzacoperchi magnetico max 20(h) cm.
- EN Counter can opener. Case hardened steel structure - stainless steel knife - magnetic lid lifter max 20(h) cm.
- FR Ouvre-boîte pour comptoir. Structure en acier cémenté - couteau en acier inox - souleveuse de couvercle magnétique max 20(h) cm.
- DE Tisch-Dosenöffner. Einsatzgehärtete Stahlstruktur - Edelmessner - Magnetdeckelheber Max 20(h) cm.



	AV4500	OPTIONAL R4501	OPTIONAL R4502
	10 x 23 x 69(h) cm	Lama di ricambio Spare blade	Ingranaggio ricambio Spare gear
	115 €	20 €	30 €

AV4585 - AV4586 AV4587

- IT Vassoio in laminato in colore teak.
- EN Teak laminate tray.
- FR Plateau en teck laminé.
- DE Laminatplatte aus Teakholz.



	AV4585	AV4586	AV4587
	Gastronorm 53x32,5 cm	Euronorm 53x37 cm	Esagonale 52x34,5 cm
	22 €	23 €	24 €

BL4545



BP4548



IT Bilancia Elettronica, fino a 15 kg con divisione in grammi 5. Corpo in ABS - piatto inox 28x21 cm - acquisizione tara - bolla di livello incorporata - tastiera con protezione antispruzzo - alimentazione a batteria ricaricabile - peso bilancia (batterie escluse) 4,1 kg. Non adatta per la vendita al pubblico.

EN Electronic Scale, up to 15 kg with division in 5 grams. - ABS casing - 28x21 cm stainless steel plate - tare acquisition - built-in level bubble - keyboard with splash protection - rechargeable battery power supply - scale weight (without batteries) 4,1 kg. Not suitable for retail sale.

FR Balance électronique, jusqu'à 15 kg avec division en 5 grammes. Corps en ABS - plaque en acier inox 28x21 cm - acquisition de la tare - bulle de niveau intégrée - clavier avec protection anti-rayures - alimentation par batterie rechargeable - poids balance (sans piles) 4,1 kg. Ne peut pas être vendue au public.

DE Elektronische Waage bis 15 kg mit Einteilung in Gramm 5. ABS Gehäuse - Edelstahltablette 28x21 cm - Tara-Erfassung - eingebaute Libelle - Tastatur mit Spritzschutz - Akku-Stromversorgung - Waagengewicht (ohne Batterien) 4,1 kg. Nicht für den Einzelhandel geeignet.

IT Bilancia Elettronica, fino a 60 kg con divisione in grammi 20. Corpo in ABS - piatto inox 32x33 cm - acquisizione tara - alimentazione a batteria + alimentatore - peso bilancia (batterie escluse) 4,5 kg. Non adatta per la vendita al pubblico.

EN Electronic Scale, up to 60 kg with division in 20 grams. ABS casing - 32x33 cm stainless steel plate - tare acquisition - battery power supply + transformer - scale weight (without batteries) 4,5 kg. Not suitable for retail sale.

FR Balance électronique, jusqu'à 60 kg avec division en 20 grammes. Corps en ABS - plaque en acier inox 32x33 cm - acquisition de la tare - alimentation par batterie + alimentation - poids de la balance (sans piles) 4,5 kg. Ne peut pas être vendue au public.

DE Elektronische Waage bis 60 kg mit Einteilung in Gramm 20. ABS Gehäuse - Edelstahltablette 32x33 cm - Tara-Erfassung - Akku-Stromversorgung + Netzteil - Waagengewicht (ohne Batterien) 4,5 kg. Nicht für den Einzelhandel geeignet.

	BL4545
	230V - 7 W
	29 x 33 x 22(h) cm
	365 €

	BP4548
	230V - 2 W
	31 x 30 x 5(h) cm
	285 €

AV4960



IT Pala in alluminio forata -per uso professionale

EN Perforated aluminium peel - for professional use

FR Pelle en aluminium perforée - pour usage professionnel

DE Perforierte Aluminiumschaufel - für den professionellen Einsatz

i	AV4960	AV4961	AV4962	AV4963
↗ cm	33 x 33 x 170(h) cm	36 x 36 x 170(h) cm	45 x 45 x 170(h) cm	50 x 50 x 170(h) cm
	196 €	208 €	241 €	254 €

AV4926



IT Pala in alluminio - per uso professionale

EN Aluminium peel - for professional use

FR Pelle en aluminium - pour usage professionnel

DE Aluminiumschaufel - für den professionellen Einsatz

i	AV4926	AV4927	AV4930	AV4930/50
↗ cm	33 x 33 x 170(h) cm	36 x 36 x 170(h) cm	45 x 45 x 170(h) cm	50 x 50 x 170(h) cm
	180 €	188 €	217 €	230 €

AV4925



IT Pala in alluminio FR Pelle pizza en aluminium

EN Aluminium peel DE Aluminiumschaufel

i	AV4925	AV4928	AV4929
↗ cm	33 x 33 x 135(h) cm	33 x 33 x 170(h) cm	36 x 36 x 170(h) cm
	113 €	128 €	139 €

AV4922



IT Palino in acciaio forato

FR Pelle de cuisson en acier perforé

EN Perforated steel turning peel

DE Perforierter Brotschieber

i	AV4922	AV4923	AV4968
↗ cm	ø 18 x 170(h) cm	ø 22 x 170(h) cm	ø 26 x 170(h) cm
	129 €	137 €	141 €



AV4920



IT Palino in acciaio

FR Pelle de cuisson en acier

EN Steel turning peel

DE Brotschieber

i	AV4920	AV4921
↗ cm	ø 18 x 170(h) cm	ø 22 x 170(h) cm
	113 €	121 €

Accessori per pizzeria
Pizzeria accessories

AV4965



IT Pala in alluminio forni elettrici e a gas
EN Aluminium peel for electric and gas ovens
FR Pelle en aluminium fours électriques et à gaz
DE Aluminiumschaufel Elektro- und Gasöfen

	AV4965
	33 x 35 x 70(h) cm
	70 €



AV4966

IT Pala per pizza al metro
EN Peel for pizza by the meter
FR Pelle à pizza au mètre
DE Pizza am Stück Schaufel

	AV4966
	60 x 40 x 170(h) cm
	249 €



AV4905

IT Paletta servi pizza in acciaio
EN Steel pizza serving peel
FR Pelle pour servir des pizzas en acier
DE Pizza-Service Stahlschaufel



	AV4905	AV4931
	ø 50 cm a 8 porzioni ø 50 cm with 8 portions	ø 33 cm
	94 €	64 €

AV4948

IT Paletta per pizza triangolare in acciaio
EN Steel triangular pizza paddle
FR Pelle triangulaire en acier pour pizza
DE Dreieckiger Stahlschaufel für Pizza



	AV4948
	15 x 25 cm
	53 €

AV4932

IT Spatola in acciaio inox
EN Stainless steel spatula
FR Spatule en acier inox
DE Edelstahlspachtel



	AV4932
	22 €

AV4954

IT Paletta per pizza in acciaio
EN Steel pizza paddle
FR Pelle à pizza en acier
DE Stahlschaufel für Pizza



	AV4954
	10 x 15 cm
	32 €

AV4941

IT Pinza prenditeglie
EN Tray clamps
FR Pincés prend plaques
DE Blechklemme





	AV4941
	51 €

AV4949

IT Rotella taglia pizza professionale
EN Professional pizza cutter
FR Roue coupe-pizza professionnelle
DE Professionelles Pizzaschneirad



	AV4949
	ø 9 cm
	75 €

AV4933

IT Bucasfoglia in lega
EN Alloy puff pastry perforator
FR Perforateur de pâte feuilletée en alliage
DE Legierung Blätterteiglöcherer





	AV4933
	80 €

AV4946

IT Raschietto inox
EN Stainless steel scraper
FR Racloir inox
DE Edelstahl Schaber



	AV4946
	12 cm
	24 €

AV4934

IT Rotella taglia pizza ø 90 mm
EN Pizza cutting wheel ø 90 mm
FR Molette coupe pizza ø 90 mm
DE Grädchen zur Pizza schneiden ø 90 mm



	AV4934
	ø 9 cm
	29 €

AV4911

IT Paletta per cenere
FR Pelle à cendres
EN Peel for ashes
DE Ascheschaufel



	AV4911
	170(h) cm
	112 €

Accessori per pizzeria
Pizzeria accessories

AV4959



IT Spazzola ottone girevole a mezzaluna

EN Brass swivel half-moon brush

FR Brosse pivotante en laiton en forme de demi-lune

DE Schwenkbare Halbmondbürste aus Messing

	AV4959	OPTIONAL A45
	170(h) cm	ricambio spazzolone a mezzaluna spare half moon brush
	131 €	40 €

AV4971



IT Spazzola doppia / ottone e raschietto in acciaio inox

EN Double brush / brass and stainless steel scraper

FR Brosse double / laiton et racloir inox

DE Doppelbürste / Messing und Edelstahlschaber

	AV4971	
	110(h) cm	
	80 €	

AV4912



IT Spazzola in fibra naturale

EN Natural fibre brush

FR Brosse en fibres naturelles

DE Naturfaserbürste

	AV4912	OPTIONAL A42
	170(h) cm	Spazzola di ricambio in fibra naturale Natural fibre brush
	105 €	30 €

AV4919



IT Spazzola in ottone per forni a legno

EN Brass brush for wood ovens

FR Brosse en laiton pour fours à bois

DE Messingbürste für Holzöfen

	AV4919	OPTIONAL A43
	170(h) cm	spazzola di ricambio in ottone Spare brass brush
	118 €	32 €

AV 4970



- IT Kit 3 pezzi 170(h) cm (pala ø 33 cm - palino ø 18 cm - spazzola)
 EN Kit 3 pieces 170(h) cm (ø 33 cm pizza peel - ø 18 cm turning peel - brush)
 FR Kit 3 pièces 170(h) cm (pelle ø 33 cm - pelle ø 18 cm - brosse)
 DE 3-teiliger Satz 170(h) cm (Schaufel ø 33 cm - kleine Schaufel ø 18 cm - Bürste)

	AV 4970
	170(h) cm
	300 €

AV 4972



- IT Kit 3 pezzi 135(h) cm (pala ø 33 cm - palino ø 22 cm - spazzola)
 EN Kit 3 pieces 135(h) cm (ø 33 cm pizza peel - ø 22 cm turning peel - brush)
 FR Kit 3 pièces 135(h) cm (pelle ø 33 cm - pelle ø 22 cm - brosse)
 DE 3-teiliger Satz 135(h) cm (Schaufel ø 33 cm - kleine Schaufel ø 22 cm - Bürste)

	AV 4972
	135(h) cm
	224 €

Accessori per pizzeria
 Pizzeria accessories

	AV 4916	
	Cassetta per appoggio pale Peel support box Cassette pour support de pelles Schaufelstützkasten	
		86 €

	AV 4913	
	Supporto reggipale a muro Wall peel support Support mural pour pelles Wandschaufelhalter	
		56 €

	AV4914	
	Supporto reggipale a muro Wall peel support Support mural pour pelles Wandschaufelhalter	
		67 €

AV4910

- IT Supporto reggipale
 EN Peel support
 FR Support de palles
 DE Schaufelträger

	AV 4910
	520x340x171(h) cm
	316 €



AV4935



IT Tagliere polietilene per pizza

EN Polyethylene cutting board for pizza

FR Planche à découper en polyéthylène pour pizza

DE Pizza-Schneidebrett aus Polyethylen



	AV4935	
	ø 35 cm	
F.P - OUT OF PRODUCTION		

AV4918

IT Alare per appoggio legna

EN Andiron stand for firewood

FR Chenet pour appui bois

DE Tragfläche für Holz



	AV4918	
93 €		

AV4952

IT Retina tonda inox

EN Little round stainless steel net

FR Grille ronde en acier inox

DE Rundes Edelstahlnetz



	AV4952	AV4953
	ø 33 cm	ø 45 cm
	29 €	43 €

AV4942



IT Oliera in acciaio inox 0,75 l

EN Stainless steel oil dispenser 0,75 L

FR Huilier en acier inox 0,75 L.

DE Edelstahl Ölflasche 0,75 L



	AV4942	
	0,75 L	
	109 €	

AV4955

IT Retina tonda alluminio

EN Little round aluminium net

FR Grille ronde en aluminium

DE Rundes Aluminiumnetz



	AV4955	AV4956	AV4957
	ø 28 cm	ø 33 cm	ø 45 cm
	F.P - OUT OF PRODUCTION	20 €	27 €

AV4938

IT Contenitore per impasti pizza

EN Pizza dough container

FR Conteneur pour pâte à pizza

DE Pizzateigbehälter



	AV4938	AV4967	AV4939 Coperchio/Cover	AV4909
	60 x 40 x 7,5(h) cm	60 x 40 x 9(h) cm	60 x 40 cm	60 x 40 x 13(h) cm
	16 €	18 €	14 €	22 €

AV4973

IT Portapizze rigido, interno in alluminio, per trasporto 10 pizze ø 33 cm.

EN Sturdy pizza holder, internally made of aluminium, for 10 pizzas ø 33 cm.

FR Conteneur thermique pour le transport de 10 pizza ø 33 cm, intérieur en aluminium.

DE Starres Pizzaregal aus Aluminium für den Transport von 10 Pizzas ø 33 cm.

	AV4973
	47 x 47 x 52(h) cm
	399 €



AV4975

IT Borsa termica 5 pizze ø 33 cm per consegna a domicilio

EN Heating Bag for 5 pizzas ø 33 cm for home delivery.

FR Sac thermique pour 5 pizzas ø 33 cm pour la livraison à domicile.

DE Wärmetasche für den Heimlieferdienst enthält 5 Pizzas ø 33 cm.

	AV4975
	37 x 37 x 20(h) cm
	62 €



AV4974

IT Piastra di fissaggio al portapacchi ciclomotore (per art. AV4973)

EN Fixing plate for moped luggage rack (for art. AV4973)

FR Plaque de fixation sur le porte-bagages du cyclomoteur (pour art. AV4973)

DE Befestigungsplatte am Mopedgepäckträger (für Art. AV4973)

	AV4974
	35 x 37 x 6,5(h) cm
	110 €



Accessori per pizzeria
Pizzeria accessories



Pattumiere-portarifiuti

GARBAGE AND DUST BINS
POUBELLES
MÜLL- UND ABFALLBEHÄLTER

AV4650-51

- IT Posacenere, gettacarte, pattumiere e portarifiuti - coperchio a rete cromata.
- EN Ashtrays, paper baskets, garbage bins and dust bins - chromed mesh lid.
- FR Cendriers, corbeilles à papier, poubelles et conteneur de déchets - couvercle en filet chromé.
- DE Aschenbecher, Papierkorb, Mülleimer und Abfallbehälter - verchromter Netzdeckel.



	AV4650	AV4651
	ø 20 - 60(h) cm	ø 25 - 70(h) cm
	108 €	176 €

AV4620

- IT Gettacarte in acciaio inox satinato Autoestinguente, testa soffocante per l'arresto della propagazione del fuoco - capacità 50 L - base in gomma.
- EN Satin stainless steel paper basket, Self-extinguishing, stifling end to stop the propagation of fire - capacity 50 L - rubber base.
- FR Corbeille à papier en acier inox satiné, Eteignant automatiquement, tête suffocante pour arrêter la propagation du feu - capacité 50 L - base en caoutchouc.
- DE Papierkorb aus satiniertem Edelstahl, Selbstlöschend erstickender Deckel zur Verhinderung der Ausbreitung von Feuer - Kapazität 50 L - Gummifuß.



	AV4620
	ø 31 - 59(h) cm
	176 €

AV4666-80

- IT Tramoggia su ruote. Struttura in acciaio inox satinato. coperchio asportabile.
- EN Hopper on wheels. Satin stainless steel casing. Removable lid.
- FR Trémie sur roues. Corps en acier inox satiné. Couvercle amovible.
- DE Trichter auf Rädern. Gehäuse aus Edelstahl matt geschliffen. Abnehmbarer Deckel.



	AV4666	AV4680 con separatore interno with internal separator
	61 x 40 x 73(h) cm	61 x 40 x 73(h) cm
	115 L	
	496 €	576 €

AV4671

- IT Pattumiera con ruote, senza pedale.
- EN Garbage bin with wheels, without pedal.
- FR Poubelle à roulettes, sans pédale.
- DE Mülleimer mit Rädern, ohne Fußhebel.



	AV4671
	ø 39 x 60(h) cm
	63 L
	295 €

AV4667
AV4668

AV4669

AV4660
AV4661
AV4663



IT Portarifiuti carrellato. Struttura a forma cilindrica in acciaio inox - completo di coperchio stampato - fondo a tenuta stagna - ruote multidirezionali. AV4667-68 con comando a pedale.

EN Wheeled waste bin. Cylindrical stainless steel structure - Complete with shaped lid - watertight bottom - multidirectional wheels. AV4667-68 with pedal control.

FR Chariot-poubelle. Corps cylindrique en acier inox - complète de couvercle imprimée - fond étanche - roues multidirectionnelles. AV4667-68 avec commande à pédale.

DE Abfalleimer auf Rädern. Zylindrisches Edelstahlgehäuse - mit vorgeformtem Deckel - wasserdichter Boden - Mehrwegräder. AV4667-68 mit Fußhebel.

IT Pattumiere tonde in acciaio inox. Cestello interno in metallo e pedale.

EN Round stainless steel waste bins. Internal metal basket and pedal.

FR Poubelles rondes en acier inox. Boîtier interne en métal et pédale.

DE Runde Abfalleimer aus Edelstahl. Interner Metallkorb und Fußhebel.

	AV4667	AV4668	AV4669
	ø 39 x 60(h) cm	ø 46 x 70(h) cm	ø 46 x 70(h) cm
	50 L	100 L	100 L
	246 €	294 €	227 €

	AV4660	AV4661	AV4663
	ø 32 x 59(h) cm	ø 32 x 74(h) cm	ø 41 x 71(h) cm
	30 L	40 L	80 L
	239 €	259 €	368 €

AV4652
AV4654



AV4681



IT Pattumiera rettangolare - Struttura in acciaio inox comando apertura a pedale - estrazione sacco anteriore - 2 ruote.

IT Pattumiera portasacco. Attacco rotondo in acciaio inox coperchio con apertura a pedale.

EN Rectangular waste bin - Stainless steel structure pedal opening control - front bag extraction - 2 wheels.

EN Bag holder. Round stainless steel fitting, lid with pedal opening.

FR Poubelle rectangulaire - Corps en acier inox commande d'ouverture par pédale - extraction du sac à l'avant - 2 roues.

FR Poubelle Porte-sac. Support rond en acier inox couvercle avec ouverture par pédale.

DE Rechteckiger Abfalleimer - Gehäuse aus Edelstahl Fußhebelöffnung - vordere Sackentnahme - 2 Räder.

DE Müllsackhalterung. Runder Edelstahldeckel mit Fußhebelöffnung.

	AV4652	AV4654
	49 x 50 x 101(h) cm	49 x 50 x 79(h) cm
	100 L	70 L
	580 €	530 €

	AV4681
	55 x 45 x 85(h) cm
	sacco grande / big bag
	254 €

Pattumiere e portarifiuti
Garbage and dust bins

CA1602 CA1603



AV4682



IT Carrello portasacco con struttura a X. Disponibile con cestino e struttura verniciata (CA1602) o con comando a pedale e struttura cromata (CA1603). Attacco rotondo - coperchio in plastica rotondo con aggancio.

EN Bag holder trolley with X structure. Available with basket and painted structure (CA1602) or with pedal control and chromed structure (CA1603). Round fitting - round plastic lid with fastener.

FR Chariot porte-sac en forme de X. Disponible avec boîtier et structure peinte (CA1602) ou avec commande à pédale et structure chromée (CA1603). Support rond - couvercle rond en plastique avec raccord.

DE Müllsackwagen mit X-förmige Struktur. Erhältlich mit Korb und lackierter Struktur (CA1602) oder mit Fußhebelöffnung und verchromter Struktur (CA1603). Runder Anschluss - runder Kunststoffdeckel mit Aufhängung.

IT Pattumiere in polietilene per raccolta differenziata - Struttura colore grigio - coperchio colorato a scelta. Ruote ø 143 mm.

EN Polyethylene waste bins for differentiated collection - Grey structure - coloured lid of your choice. Wheels ø 143 mm.

FR Poubelles en polyéthylène pour collecte différenciée - Structure de couleur grise - couvercle de couleur de votre choix. Roues ø 143 mm.

DE Abfalleimer aus Polyethylen zur getrennten Entsorgung - graue Struktur - farbiger Deckel Ihrer Wahl. Räder ø 143 mm.

	CA1602	CA1603
	58 x 56 x 102(h) cm	58 x 56 x 102(h) cm
	225 €	265 €

	AV4682Y giallo/yellow	AV4682R rosso/red	AV4682B blu/blue	AV4682G verde/green
	54 x 49 x 85(h) cm			
	80 L			
	61 €			

AV4675



AV4674



AV4676



AV4678



AV4679



IT Pattumiere in polietilene.
Diversi colori disponibili.
Ruote \varnothing 200 mm.

EN Polyethylene waste bins.
Several colours available.
Wheels \varnothing 200 mm.

FR Poubelles en polyéthylène.
Différentes couleurs disponibles.
Roues \varnothing 200 mm.

DE Abfalleimer aus Polyethylen.
Erhältlich in verschieden Farben.
Räder \varnothing 200 mm.

OPTIONAL RC 0075

Pedale apricoperchio per contenitore
Pedal lid opener for container
Pédale ouvre-couvercle pour conteneur
Deckelöffnungsfußhebel

62 €

	AV4674	AV4675	AV4676	AV4678	AV4679
	55 x 48 x 93(h) cm				
	120 L				
	100 €				

Pattumiere e portarifiuti
Garbage and dust bins

HLA-HLC HLE-HLF



HLECB



HLFA



HLEBD



HLEN

Lampade riscaldanti







HEATING LAMPS
LAMPES CHAUFFANTES
LÁMPARAS DE CALEFACCIÓN







IT Lampade riscaldanti a infrarossi a sospensione - disponibili in diverse forme come da foto, nei colori nero, argento, oro e rame.







EN Infrared hanging heating lamps - available in different shapes as shown in the picture, in black, silver, gold and copper.







FR Lampes chauffantes à infrarouge à suspension - disponibles en différentes formes comme indiqué sur la photo, en noir, argent, or et cuivre.

DE Infrarot-Heizlampen zum Aufhängen - erhältlich in verschiedenen Formen, wie auf dem Bild gezeigt, in Schwarz, Silber, Gold und Kupfer.

	HLAN nero / black	HLAA argento / silver	HLEBD oro / gold	HLEBB rame / copper
	250 W			
	230V/50-60 HZ			
	+30° +90°C			
	ø 175 mm			
	90 €	90 €	115 €	115 €

	HLCN nero / black	HLCA argento / silver	HLECD oro / gold	HLECB rame / copper
	250 W			
	230V/50-60 HZ			
	+30° +90°C			
	ø 270 mm			
	100 €	100 €	115 €	115 €

	HLFN nero / black	HLFA argento / silver	HLEFD oro / gold	HLEFB rame / copper
	250 W			
	230V/50-60 HZ			
	+30° +90°C			
	ø 270 mm			
	100 €	100 €	115 €	115 €

	HLEN nero / black	HLEA argento / silver	HLEED oro / gold	HLEEB rame / copper
	250 W			
	230V/50-60 HZ			
	+30° +90°C			
	ø 290 mm			
	100 €	100 €	115 €	115 €

SUVN SUVN2P



SUVN2P



SUVN

Sterilizzatori universali a raggi UV











UNIVERSAL UV STERILISERS
STÉRILISATEURS UV UNIVERSELS
UNIVERSAL-UV-ENTKEIMUNGSGERÄTE

IT Armadietto sterilizzatore universale a raggi UV costruito in acciaio inox con finitura Scotch Brite. Adatto per utensilerie varie - funzionamento con lampada germicida con griglia di protezione - portina in plexiglas trasparente con microinterruttore - temporizzatore 60' e lampada spia di funzionamento - cavo con spina. Disponibili ad uno o due scomparti.

EN Universal UV steriliser cabinet made of stainless steel with Scotch Brite finish. Ideal for various tools - germicidal lamp operation with protection grid - clear Plexiglas door with microswitch - 60' timer and indicator lamp - cable with plug. Available with one or two compartments.

FR Armoire stérilisateur UV universelle en acier inox avec finition Scotch Brite. Indiqué pour divers ustensiles - fonctionnement avec lampe germicide avec grille de protection - porte en plexiglas transparent avec microinterrupteur - minuteur 60' et indicateur lumineux de fonctionnement - câble avec fiche. Disponible avec une ou deux compartiment.

DE UV-Sterilisationsschrank aus Scotch Brite Edelstahl. Geeignet für verschiedene Utensilien - Funktionsweise mit keimtötender Lampe mit Schutzgitter - klare Plexiglastür mit Mikroschalter - 60'-Timer und Anzeigelampe - Kabel mit Stecker. Erhältlich mit einem oder zwei Einlegeböden.

	SUVN	SUVN2P
	0,16 kW	0,16 x 2 kW
 1 Ph	230V/50Hz	
 mm	510 x 280 x 350(h) mm	510 x 280 x 700(h) mm
		
 NET Kg	7,5 Kg	
 GROSS Kg	9 Kg	
 mm	550 x 450 x 550(h) mm	680 x 400 x 900(h) mm
 m ³	0.136 m ³	0.244 m ³
	450 €	800 €

LP800-LP850 LP1000-LP1050



LP800CA



CARBON
CHARCOAL GRAY

NUOVI COLORI DISPONIBILI
NEW COLORS AVAILABLE



LP800B

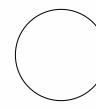

BIANCO
WHITE



LP800CE



CENERE
ASH GRAY



Carrelli di servizio
in legno

WOODEN SERVICE TROLLEYS
CHARIOTS DE SERVICE EN BOIS
SERVICEWAGEN AUS HOLZ

IT Carrelli di servizio in legno. Struttura in legno massello - ripiani in nobilitato di betulla - ruote multidirezionali cromate ø 100 mm. Telaio e cupola dello stesso colore acquistabile a parte e facilmente applicabile. Colorazioni a poro aperto disponibili in: bianco, cenere e carbon.

EN Wooden service trolleys. Solid wood structure - birch multi-layered wood shelves - multidirectional chrome-plated wheels ø 100 mm. Easy to assemble frame and dome in the same colour, to be separately purchased. Open pore finishes available in: white, ash and carbon.

FR Chariots de service en bois. Structure en bois massif - étagères en bouleau mélaminé -roues multidirectionnelles chromées ø 100 mm. Cadre et dôme de la même couleur vendus séparément et facilement applicables. Couleurs à pores ouverts disponibles en : blanc, cendré et carbone.





DE Servicewagen aus Holz. Struktur aus Massivholz - Ablagefläche aus Birkenfurnierholz - Mehrweg-Chromräder ø 100 mm. Gestell und Deckel der gleichen Farbe sind separat erhältlich und leicht anzubringen. Offenporige Farbgebung in den Farben: Weiß, Aschgrau und Carbon.











CARBON
CHARCOAL GRAY





CENERE
ASH GRAY

BIANCO
WHITE

	LP800CA carbon/charcoal gray	LP800CE cenere/ash gray	LP800B bianco/white	LP850CA carbon/charcoal gray	LP850CE cenere/ash gray	LP850B bianco/white
	81 x 55 x 108(h) cm					
	2			3		
	80 Kg					
	930 €			1.110 €		

	TELAIO + CUPOLA / FRAME + DOME / GESTELL + DECKEL / CADRE + DÔME		
	A1236 for model LP800/850CA	A1237 for model LP800/850CE	A1238 for model LP800/850B
	470 €		

	LP1000CA carbon/charcoal gray	LP1000CE cenere/ash gray	LP1000B bianco/white	LP1050CA carbon/charcoal gray	LP1050CE cenere/ash gray	LP1050B bianco/white
	115 x 55 x 108(h) cm					
	2			3		
	80 Kg					
	975 €			1.160 €		

	TELAIO + CUPOLA / FRAME + DOME / GESTELL + DECKEL / CADRE + DÔME		
	A1233 for model LP1000/1050CA	A1234 for model LP1000/1050CE	A1235 for model LP1000/1050B
	90 x 50 x 22(h) cm		
	520 €		



A1235



A1234



ML3202SS ML3204SS



NUOVI COLORI DISPONIBILI
NEW COLORS AVAILABLE



ML3202SSCE



ML3202SSCA



CARBON
CHARCOAL GRAY



ML3204SSCE



CENERE
ASH GRAY

Mobili di servizio
in legno



WOOD SERVICE FURNITURE
MEUBLES DE SERVICE EN BOIS
SERVICEMÖBEL AUS HOLZ

IT Mobili di servizio in legno. Mobili di servizio bassi doppi - struttura e pannelli in nobilitato - 2 cassetti portaposate di cui 1 con separatore - 2 sportelli - ruote multidirezionali ø 50 mm. Colorazioni a poro aperto disponibili in: cenere e carbon.

EN Wooden service cabinets. Low double service cabinets - melamine structure and panels - 2 cutlery drawers, 1 with separator - 2 doors - multidirectional wheels ø 50 mm. Open pore finishes available in: ash and carbon.

FR Meubles de service en bois. Meubles bas de service double - structure et panneaux en mélaminé - 2 tiroirs à couverts dont 1 avec séparateur - 2 portes - roues multidirectionnelles ø 50 mm. Couleurs à pores ouverts disponibles en : cendré et carbone.

DE Servicemöbel aus Holz. Niedrige Doppelservicemöbel - Struktur und Blenden aus Melamin - 2 Besteckschubladen, davon 1 mit Trennwand - 2 Türen - Mehrwegräder ø 50 mm. Offenporige Farbgebung in den Farben: Aschgrau und Carbon.

	ML3202SSCA carbon/charcoal gray	ML3202SSCE cenere/ash gray
		
	90 x 48 x 95(h) cm	
	2 sportelli - 2 cassetti 2 doors - 2 drawers	
	1.255 €	



CARBON
CHARCOAL GRAY

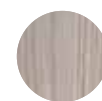



CENERE
ASH GRAY

IT Mobili di servizio bassi tripli - struttura e pannelli in nobilitato - 3 cassetti portaposate di cui 2 con separatore - 2 sportelli - 1 vano interno - ruote multidirezionali ø 50 mm. Colorazioni a poro aperto disponibili in: cenere e carbon.

EN Low triple service cabinets - melamine structure and panels - 3 cutlery drawers, 2 with separator - 2 doors - 1 internal compartment - multidirectional wheels ø 50 mm. Open pore finishes available in: ash and carbon.

FR Meubles bas de service triple - structure et panneaux mélaminés - 3 tiroirs à couverts, dont 2 avec séparateur - 2 portes - 1 compartiment intérieur - roues multidirectionnelles ø 50 mm. Couleurs à pores ouverts disponibles en : cendré et carbone.

DE Niedrige Trippelservicemöbel - Struktur und Blenden aus Melamin - 3 Besteckschubladen, davon 2 mit Trennwand - 2 Türen - 1 Innenfach - Mehrwegräder ø 50 mm. Offenporige Farbgebung in den Farben: Aschgrau und Carbon.

	ML3204SSCA carbon/charcoal gray	ML3204SSCE cenere/ash gray
		
	136 x 48 x 95(h) cm	
	2 sportelli - 3 cassetti - 1 vano interno 2 doors - 3 drawers - 1 internal compartment	
	1.640 €	



CARBON
CHARCOAL GRAY

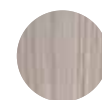

CENERE
ASH GRAY

Condizioni generali di vendita

GENERAL SALES CONDITIONS
CONDITIONS GÉNÉRALES DE VENTE
ALLGEMEINE VERKAUFSBEDINGUNGEN
CONDICIONES GENERALES DE VENTA
ОБЩИЕ УСЛОВИЯ ПРОДАЖИ

IT

COSTO DELL'IMBALLO: compreso nel prezzo per le macchine - ricambi ed accessori € 5,00.

COSTO FISSO GESTIONE ORDINI: € 5,00 solo per ordini di importo inferiore a € 80,00.

CONDIZIONI DI PAGAMENTO: Si richiede il pagamento con bonifico bancario per:

1. prime forniture. **2.** al superamento del fido. **3.** invio dei ricambi.

DILAZIONI DI PAGAMENTO: da definire.

PREZZI: non sono impegnativi, possono subire variazioni senza obbligo di preavviso, in tal caso saranno confermati all'ordine.

Tutti i prezzi sono esclusi di IVA.

TERMINI DI CONSEGNA:

1. Possibile spedizione giornaliera per macchine disponibili a magazzino (solo in Italia).

2. Per macchine da produrre circa 25 giorni salvo imprevisti.

ASSISTENZA TECNICA: a carico del RIVENDITORE per tutta la durata della garanzia di anni uno.

Fimar S.p.a. si impegna a fornire, in garanzia, tutti i componenti di ricambio ritenuti difettosi. Il prezzo di vendita fatturato all'utilizzatore finale comprenderà non solo il prezzo dei prodotti finiti venduti ma anche la gestione, da parte del rivenditore, della garanzia a copertura di essi. Fimar S.p.a. non dovrà sostenere alcuna spesa diretta o indiretta sostenuta dal rivenditore per la gestione della garanzia.

INSTALLAZIONE: a carico del rivenditore.

TRASPORTO: FRANCO FABBRICA, la merce viaggia a rischio e pericolo del committente, per cui Fimar S.p.a. non è responsabile per eventuali danni subiti dalla merce durante il trasporto. Eventuali contestazioni dovranno essere effettuate all'atto della consegna entro i termini di legge.

GARANZIA: 12 mesi.

ASSICURAZIONE: tutte le nostre macchine sono coperte da assicurazione (responsabilità civile verso terzi) Escluso U.S.A. e CANADA.

CATALISTINO: la presente documentazione annulla tutte le precedenti. I dati tecnici, le illustrazioni e le immagini riportate nel presente sono puramente indicativi. La Ditta si riserva il diritto di modificare le caratteristiche tecniche ed estetiche o sospendere, in ogni momento, la propria produzione senza obbligo di preavviso.

IMMAGINI ED ILLUSTRAZIONI: tutte le immagini realizzate dal produttore sono coperte da copyright. L'utilizzo o la riproduzione delle medesime sono soggetti ad autorizzazione da parte della Ditta proprietaria del marchio e detentrica dei diritti di proprietà materiale ed intellettuale. I prezzi potranno subire variazioni nel caso di errori tipografici

MARCHI E BREVETTI: è fatto espresso divieto di utilizzare i marchi e/o i brevetti registrati dalla Fimar S.p.a.

Si precisa che tutti i macchinari e gli accessori non marcati CE presentano caratteristiche specifiche che non li rendono idonei alla vendita all'interno dei paesi dell'Unione Europea.

MOD173V00 - FINITO DI STAMPARE IN FEBBRAIO 2022
VERSIONE ONLINE AGGIORNATA A 09.2022

EN

PACKAGING COST: included in the price of the machines - spare parts and accessories € 5,00.

ORDER MANAGEMENT FIXED FEE: € 5,00 only for orders of less than € 80,00

PAYMENT TERMS: Payment by bank transfer is required for:

1. first orders. **2.** in the event that the exposure is exceeded.

3. spare parts delivery.

PAYMENT DEFERMENT: to be defined.

PRICES: are not binding, may change without notice, in which case they will be confirmed with the order. Prices not include VAT.

DELIVERY TERMS:

1. Daily shipping possible for machines available in stock (in Italy only).

2. Delivery possible within 1 week from order for goods in stock.

3. For machines to be produced about 25 days unless unforeseen events occur.

TECHNICAL SUPPORT: to be provided by the DEALER for the duration of the warranty period of one year.

Fimar S.p.a. undertakes to supply, on warranty, all spare parts considered defective. The sales price invoiced to the end user will include not only the price of the end products sold but also the management, by the retailer, of their warranty. Fimar S.p.a. shall not incur any direct or indirect expenses borne by the retailer for the management of the warranty.

INSTALLATION: to be performed by the dealer.

TRANSPORT: EX WORKS, the goods travel at risk and danger of the customer, Fimar S.p.a. is not responsible for any damage suffered by the goods during transport. Any disputes must be made at reception within the terms of the law.

WARRANTY: 12 months.

INSURANCE: all our machines are covered by insurance (third party liability) Excluding U.S.A. and CANADA.

CATALOGUE & PRICE LIST: This documentation voids all previous documentation. Technical data, drawings and images in this catalogue are purely indicative. The Company reserves the right to modify the technical and aesthetic characteristics or suspend, at any time, its production without notice.

IMAGES AND DRAWINGS: all images made by the manufacturer are protected by copyright. The use or reproduction of the same is subject to authorization by the trademark owner who holds the material and intellectual property rights. Prices may vary in the event of misprints.

BRANDS and PATENTS: it is expressly forbidden to use the trademarks and/or patents registered by Fimar S.p.a.

It should be noted that all machinery and accessories not bearing the CE mark have specific characteristics that make them unsuitable for sale within the countries of the European Union.

MOD173V00 - PRINTING COMPLETED IN FEBBRAIO 2022
UPDATE ONLINE 09.2022

FR

FRAIS D'EMBALLAGE: inclus dans le prix des machines - pièces détachées et accessoires € 5,00.

FRAIS DE GESTION DE COMMANDE: € 5,00 uniquement pour les commandes inférieures à € 80,00

PAIEMENT: Le paiement par virement bancaire est requis pour:

1. premières fournitures. **2.** l'excès du risque d'exposition.

3. l'envoi de pièces détachées.

PAIEMENTS DILATÉS: à définir.

PRIX: ils ne sont pas contractuels, peuvent être modifiés sans préavis, auquel cas ils seront confirmés lors de la commande. Tous les prix s'entendent hors TVA.

CONDITIONS DE LIVRAISON:

1. Possibilité d'expédition sur la journée pour les machines disponibles en stock (uniquement en Italie).

2. Possibilité de livraison dans un délai d'une semaine à compter de la date de commande pour les produits en stock.

3. Pour les machines à produire environ 25 jours, sauf circonstances prévues.

ASSISTANCE TECHNIQUE: à imputer au DISTRIBUTEUR pour la durée de la garantie d'un an.

Fimar S.p.a. s'engage à fournir, sous garantie, toutes les pièces détachées considérées comme défectueuses. Le prix de vente facturé à l'utilisateur final comprendra non seulement le prix des produits finis vendus mais aussi la gestion, par le distributeur, de la garantie qui les couvre. Fimar S.p.a. n'encourt aucun frais direct ou indirect pour la gestion de la garantie.

INSTALLATION: à imputer au revendeur.

TRANSPORT: EX WORKS, les marchandises voyagent aux risques et périls du client, Fimar S.p.a. n'est donc pas responsable des dommages subis par les marchandises pendant leur transport. Toute contestation doit être faite au moment de la livraison dans les conditions prévues par la loi.

GARANTIE: 12 mois.

ASSURANCE: toutes nos machines sont couvertes par une assurance (responsabilité civile) sauf les États-Unis et le Canada.

CATALOGUE ET LISTE PRIX: Cette documentation annule toute la documentation précédente. Les données techniques, illustrations et images de cette documentation sont données à titre purement indicatif. La Société se réserve le droit de modifier les caractéristiques techniques et esthétiques ou de suspendre, à tout moment, sa production sans préavis.

IMAGES ET ILLUSTRATIONS: toutes les images réalisées par le fabricant sont couvertes par le droit d'auteur. L'utilisation ou la reproduction de ceux-ci est soumise à l'autorisation de la société propriétaire de la marque et titulaire des droits de propriété matérielle et intellectuelle. Les prix peuvent varier en cas d'erreurs typographiques.

MARQUES ET BREVETS: il est expressément interdit d'utiliser les marques et/ou brevets déposés par Fimar S.p.a.

Il est à noter que toutes les machines et accessoires sans marquage CE présentent des caractéristiques spécifiques qui les rendent impropres à la vente dans les pays de l'Union Européenne.

MOD173V00 - EMPRIMÉ ET TERMINÉ EN FEBRUARY 2022
VERSION NUMÉRIQUE ACTUALISÉE 09.22

DE

VERPACKUNGSKOSTEN: Im Maschinenpreis enthalten - Ersatzteile und Zubehör € 5,00.

FESTE AUFTRAGSVERWALTUNGSKOSTEN: € 5,00 nur bei einem Bestellwert unter € 80,00.

ZAHLUNGSBEDINGUNGEN: Die Zahlung per Banküberweisung ist erforderlich bei:

1. erste Lieferungen.
2. Überschreitung der Kreditgrenze.
3. Versand von Ersatzteilen.

ZAHLUNGSAUFSCHUB: nach Absprache.

PREISE: sind nicht verbindlich, können ohne Vorankündigung geändert werden, in diesem Fall werden sie bei der Bestellung bestätigt. Alle Preise verstehen sich zuzüglich der gesetzlichen Mehrwertsteuer.

LIEFERBEDINGUNGEN:

1. Möglicher Tagesversand für lagerhaltige Maschinen (nur in Italien)
2. Möglicher Versand der Ware innerhalb von 1 Woche nach Bestellung für lagerhaltige Produkte.
3. Für Neumaschinen, ca. 25 Tage, vorbehaltlich unvorhergesehener Umstände.

TECHNISCHE UNTERSTÜTZUNG: zu Lasten des Wiederverkäufers für die Dauer der Garantie von einem Jahr.

Fimar S.p.a. verpflichtet sich, im Rahmen der Garantie alle als defekt geltenden Ersatzteile zu liefern. Der dem Endverbraucher in Rechnung gestellte Verkaufspreis umfasst nicht nur den Preis der verkauften Endprodukte, sondern auch die Verwaltung ihrer Garantie durch den Wiederverkäufer. Fimar S.p.a. ist nicht verpflichtet, dem Wiederverkäufer direkte oder indirekte Kosten für die Verwaltung der Garantie zu erstatten.

INBETRIEBNAHME: zu Lasten des Wiederverkäufers.

VERSAND: EX WORKS, die Waren reisen auf Gefahr und Risiko des Kunden, Fimar S.p.a. ist nicht für Schäden an der Ware während des Versands verantwortlich. Etwaige Streitigkeiten müssen zum Zeitpunkt der Lieferung im Rahmen der gesetzlichen Bestimmungen geltend gemacht werden.

GARANTIE: 12 Monate.

VERSICHERUNG: Alle unsere Maschinen sind durch eine Versicherung (Haftpflicht) abgedeckt, mit Ausnahme in den USA und KANADA.

LISTEN-KATALOG: die vorliegende Unterlage ersetzt sämtliche früheren Versionen. Die technischen Daten, Abbildungen und Bilder in dieser Unterlage dienen nur der Information. Das Unternehmen behält sich das Recht vor, die technischen und ästhetischen Eigenschaften zu ändern oder die Produktion jederzeit und ohne Vorankündigung einzustellen.

BILDER UND ZEICHNUNGEN: alle vom Hersteller hergestellten Bilder unterliegen dem Urheberrecht. Die Verwendung oder Vervielfältigung derselben bedarf der Genehmigung der Eigentümerfirma der Marke und der materiellen und geistigen Eigentumsrechte. Preisänderungen sind aufgrund von Schreibfehlern möglich.

MARKEN UND PATENTE: es ist ausdrücklich verboten, die von Fimar S.p.a. registrierten Marken und/oder Patente zu verwenden.

Wir weisen darauf hin, dass alle Maschinen und Zubehörteile, die nicht mit dem CE-Zeichen gekennzeichnet sind, besondere Merkmale aufweisen, die sie für den Verkauf in den Ländern der Europäischen Union ungeeignet machen.

MOD173V00 - DRUCK FERTIGGESTELLT IM FEBRUAR 2022
ONLINE-VERSION AKTUALISIERT AUF 09.2022

ES

COSTE DE EMBALAJE: incluido en el precio para las máquinas - € 5,00 para repuestos y accesorios.

COSTE FIJO GESTIÓN PEDIDOS: € 5,00 sólo para pedidos con importe inferior a 80,00 €.

CONDICIONES DE PAGO: Se exige el pago con transferencia bancaria en estos casos:

1. primeros suministros.
2. superación del crédito.
3. envío de repuestos.

APLAZAMIENTO DE PAGO: por definir.

PRECIOS: no son vinculantes; pueden sufrir modificaciones sin que la empresa esté obligada a avisar previamente de los cambios. En este caso, se confirmarán los precios al realizar un pedido. Todos los precios incluyen IVA.

CONDICIONES DE ENTREGA:

1. Envío diario para máquinas disponibles en el almacén (sólo Italia).
2. Posible devolución de los productos disponibles en almacén dentro de 1 semana a partir de la fecha del pedido.
3. Aproximadamente 25 días, salvo circunstancias imprevistas, para máquinas que se deben fabricar.

ASISTENCIA TÉCNICA: A cargo del distribuidor durante todo el periodo de garantía (1 año). Durante el periodo de garantía Fimar S.p.a. se compromete a proporcionar todos los componentes de repuesto considerados defectuosos. El precio de venta facturado al usuario final incluye no sólo el precio de los productos acabados vendidos, sino también la gestión, por parte del distribuidor, de su garantía. Fimar S.p.a. no se asume ningún gasto directo o indirecto soportado por el distribuidor por la gestión de la garantía.

INSTALACIÓN: A cargo del distribuidor.

TRANSPORTE: FRANCO FABBRICA, Los productos viajan por cuenta y riesgo del cliente; por lo tanto, no se asume ninguna responsabilidad por los posibles daños que pueden ocurrir durante el transporte. Las reclamaciones deberán realizarse en el momento de la entrega y siempre conforme con la ley.

GARANTÍA: 12 meses.

SEGURO: todas nuestras máquinas están cubiertas por seguro (responsabilidad civil frente a terceros). Estados Unidos y Canadá excluidos.

CATÁLOGO: el presente catálogo anula todos los anteriores. Los datos técnicos, las ilustraciones y las fotos que se incluyen en este catálogo han de considerarse puramente indicativos. se reserva el derecho de modificar las características técnicas y estéticas, o de suspender, en cualquier momento, su producción sin ninguna obligación de avisar previamente.

IMÁGENES, ILUSTRACIONES Y FOTOS: todas las imágenes realizadas por el productor están bajo derechos de autor. Su uso o reproducción está sujeto a autorización por parte de la empresa propietaria de la marca y titular de los derechos de propiedad material e intelectual. Los precios pueden sufrir modificaciones en caso de errores tipográficos.

MARCA Y PATENTE: se prohíbe expresamente utilizar las marcas y/o las patentes registradas por Fimar S.p.a.

Se precisa que todas las máquina y los accesorios que no llevan la marca CE (CEE) tienen características específicas por las cuales estos productos resultan ser no aptos para la venta en los países de la Unión Europea.

MOD173V00 - IMPRESO EN FEBRERO DE 2022
VERSIÓN DIGITAL ACTUALIZADA AL 09.2022

RU

СТОИМОСТЬ УПАКОВКИ: включена в цену на машины - запчасти и аксессуары € 5,00.

ФИКСИРОВАННАЯ СТОИМОСТЬ УПРАВЛЕНИЯ ЗАКАЗАМИ: € 5,00 для заказов на сумму менее € 80,00.

УСЛОВИЯ ОПЛАТЫ: Оплата банковским переводом необходима для:

1. первые поставки.
2. когда кредитный лимит превышен.
3. отправка запчастей.

РАСШИРЕНИЕ ПЛАТЕЖЕЙ: подлежит определению.

ЦЕНЫ: они не являются обязательными, они могут подвергаться изменениям без предварительного уведомления, и в этом случае они будут подтверждены к заказу. Все цены указаны без НДС.

УСЛОВИЯ ДОСТАВКИ:

1. Возможна ежедневная отгрузка для машин, имеющихся в наличии (только в Италии).
2. Возможен возврат товара в течение 1 недели с момента заказа товара на складе.
3. Для машин, чтобы произвести около 25 дней, за исключением непредвиденных событий.

ТЕХНИЧЕСКАЯ ПОМОЩЬ: взимается с ДИЛЕРОМ на весь срок гарантии один год.

Fimar S.p.a. обязуется поставлять по гарантии все запасные части, признанные дефектными. Цена продажи, выставленная конечному пользователю, будет включать в себя не только цену проданной готовой продукции, но и управление розничным продавцом гарантийных обязательств, покрывающих их. Fimar S.p.a. не будет нести никаких прямых или косвенных расходов, понесенных продавцом для управления гарантийным обслуживанием.

УСТАНОВКА: взимается с продавца.

ТРАНСПОРТИРОВКА: ФРАНЦУЗСКИЙ ФАБРИКА, товары перемещаются на риск клиента, для которого Fimar SpA не несет ответственности за повреждение товара при транспортировке. Любые споры должны быть сделаны при доставке в соответствии с законом.

ГАРАНТИЯ: 12 месяцев.

СТРАХОВАНИЕ: все наши машины покрыты страховкой (ответственность третьих лиц), исключая США и КАНАДА

КАТАЛОГ: эта документация отменяет все предыдущие. Технические данные, иллюстрации и изображения, показанные здесь, являются исключительно ориентировочными. Компания оставляет за собой право изменять технические и эстетические характеристики или приостанавливать в любое время производство без предварительного уведомления.

ИЗОБРАЖЕНИЯ И ИЛЛЮСТРАЦИИ: все изображения, изготовленные производителем, защищены авторским правом. Использование или воспроизведение этих материалов подлежат разрешению со стороны Компании, которая владеет брендом и владеет правами на материальную и интеллектуальную собственность. Цены могут измениться в случае опечаток.

ТОВАРНЫЕ ЗНАКИ И ПАТЕНТЫ: категорически запрещено использовать торговые марки и / или патенты, зарегистрированные Fimar SpA.

Следует отметить, что все машины и аксессуары без маркировки CE имеют специфические характеристики, которые не позволяют использовать их в странах Европейского Союза.

MOD173V00 - ЗАВЕРШЕНА В ДЕКАБРЕ 2022 ГОДА
ОНЛАЙН-ВЕРСИЯ ОБНОВЛЕНА ДО 09. 2022

fimar group

Fimar S.p.a.

Via Del Tesoro, 301 - 47826 Villa Verucchio (Rimini) Italy
t. +39 0541 670736 - f. +39 0541 670576 - info@fimargroup.it



FIMARGROUP.IT
FIMARSPA.IT
EASYLINEBYFIMAR.IT
FORCAR.IT
FORCOLD.IT