



Wine Display Cabinets

Collection 23



IT | EN | FR

WINE LIBRARY

Un **esaltante**
gioco di riflessi

Eye-catching
reflection effects

Un jeu de reflets
captivant

 enofrigo®

WINE LIBRARY

Un esaltante gioco di riflessi

Il luogo ideale dove accogliere le eccellenze vitivinicole offrendo le condizioni ottimali per la miglior conservazione e valorizzazione delle bottiglie. Linee pulite, supporti trasparenti, illuminazione a led lungo le porte, interni a specchio, maniglie in acciaio inox e laminati moderni sono l'espressione di un design moderno ed elegante che garantisce massimo risalto all'alta qualità dell'offerta enologica.

Eye-catching reflection effects

Here is an ideal way to display bottles and ensure exactly the right conditions for preserving and enhancing excellent wines. Clean lines, transparent bottle supports, LED door lighting, mirror-finish interiors, stainless steel handles and the latest laminates combine to embody a modern, elegant design that will add prestige to any high quality wine selection.

Un jeu de reflets captivant

L'endroit idéal pour accueillir l'excellence vitivinicole offrant des conditions optimales pour conserver au mieux vos bouteilles et les mettre en valeur. Lignes épurées, supports transparents, éclairage LED le long des portes, intérieurs miroirs, poignées en acier inoxydable et stratifiés modernes, autant de détails qui sont l'expression d'un design contemporain et élégant qui garantit une mise en valeur optimale de la très grande qualité de l'offre œnologique.

 ALL ROUND VISIBILITY

 CUSTOM INTERNAL LAYOUT

WINE LIBRARY

Visibilità a 360°
All-round visibility
Visibilité à 360°



ALL ROUND
VISIBILITY

WALL

ISOLA

ISOLA 4V



Visibilità a 360°

L'esposizione utile estremamente ampia, con i led (2700°K) posizionati lungo il perimetro della porta e gli interni a specchio mettono in risalto al massimo le bottiglie.

All-round visibility

The Wine Library's wide display area features LED lights (2700°K) along the perimeter of the door as well as mirrored internal walls, creating a striking effect for the ultimate bottle display with a 360° view effect.

Visibilité à 360°

La vaste surface d'exposition, les LED (2700°K) placées sur tout le pourtour de la porte et l'intérieur miroir participent à la mise en scène des bouteilles.

WINE LIBRARY

Una modularità plug and play
 Plug&Play modularity
 Une modularité plug and play



LUXURY
 EXTERNAL
 SURFACES

Wine

2 ALTEZZE
 HEIGHT - HAUTEURS

255 cm

215 cm

145 cm

213 cm

59 cm

2 MODULI
 UNITS - MODULES

3 MODULI
 UNITS - MODULES



Formati modulari

Disponibilità di scelta tra due diverse altezze del modulo, moduli a due oppure a tre porte. Ogni modulo è dotato di un sistema di gestione indipendente della temperatura e dell'umidità (optional) nel singolo vano refrigerato. Porte vetro fronte/retro o retro chiuso con interno in acciaio inox, finitura a specchio.

Modular size options

Two height options and two or three door models are available. Each unit is equipped with a stand-alone temperature and humidity (optional) control kit for the refrigerated compartment. Front/rear doors or a closed back are also options, along with internal mirrored stainless steel.

Formats modulaires

Choix possible entre deux hauteurs de modules et modules à deux ou trois portes. Chaque module est équipé d'un système de gestion indépendant de la température et de l'humidité (en option) dans chaque compartiment réfrigéré. Portes en verre avant/arrière ou arrière fermé avec intérieur en stratifié miroir.



Rivestimento

La struttura del mobile è rivestita in laminati "metal" (873) o "soft touch" (720, 718).

I telai delle porte sono in alluminio anodizzato grigio o nero. Optional: è possibile scegliere altri colori per il rivestimento in laminato, ma il telaio della porta rimane anodizzato grigio o nero.

Linings

Cabinet structure covered in "metal" (873) or "soft touch" (720, 718) laminates.

Door frames are in grey or black anodised aluminium.

Optional: other laminate covering colours can be specified, but door frames are available only in anodized grey or black.

Revêtements

La structure du meuble est habillée de stratifiés "métal" (873) ou "soft touch" (720, 718).

Les châssis de portes sont en aluminium anodisé gris ou noir.

Option: choix possible d'autres coloris pour le revêtement en stratifié, mais le châssis de la porte reste anodisé gris ou noir.

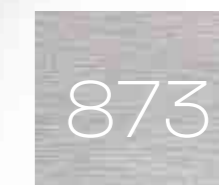

873 Grigio Alluminio Satinato
 Brushed Aluminium Grey
 Gris aluminium satiné

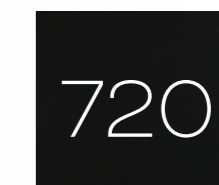

720 Nero opaco "Soft Touch"
 "Soft Touch" Matte Black
 "Soft Touch" Noir

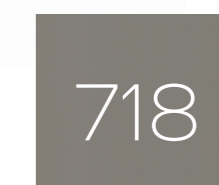

718 Grigio Opaco "Soft Touch"
 "Soft Touch" Matte Grey
 "Soft Touch" Gris

WINE LIBRARY

Spazi interni più ampi e facilmente personalizzabili

Grazie all'innovativo sistema di refrigerazione gli interni sono privi della piastra evaporante. Viene aumentata la capienza di bottiglie e l'interno a specchio crea un effetto di visibilità a 360°. Possibilità di disporre le bottiglie in verticale, in obliquo o in orizzontale, a seconda delle preferenze. Su ripiani inox (R) o in plexiglass forati (P), su tubi in acciaio (T, A) o su eleganti culle trasparenti in plexiglass (C).

Internal system and custom internal layout

The innovative, ventilated refrigeration system in the Wine Library maintains the correct temperature without using an evaporator and consequently gaining interior space. Bottles can be displayed in a variety of positions, according to individual needs and tastes: vertically, with stainless steel (R) or plexiglass (P) shelves, on an incline, with stainless steel tubes (A) or horizontally (T), with plexiglass supports (C).

Intérieurs propres et agencement personnalisable

Grâce au système de froid innovant, les intérieurs restent propres sans la plaque d'évaporation. La capacité en nombre de bouteilles est augmentée et l'intérieur miroir crée un effet panoramique à 360°. Possibilité de disposer les bouteilles à la verticale, inclinées ou à l'horizontale, selon vos préférences. Sur des étagères en inox perforées (R), à tubes en acier (T) ou sur d'élégantes berceaux transparentes en plexiglas (C).

Costruisci l'allestimento interno a seconda delle tue esigenze
Internal equipment can be installed to meet your needs
Agencez l'intérieur en fonction de vos besoins



CUSTOM
INTERNAL
LAYOUT

Wine

R
42*



Ripiani in acciaio
Stainless Steel Shelves
Étagères en acier

P



non superare 20 kg
not to exceed 20 kg
ne pas dépasser 20 kg

Ripiani in Plexiglass
Plexiglass Shelves
Étagères en plexiglas

C
10*

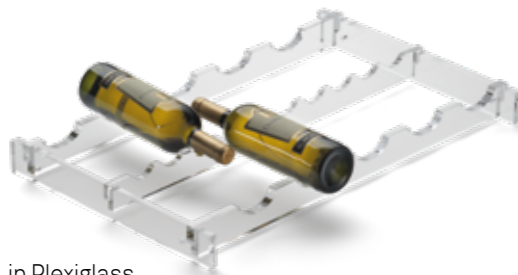

Supporti orizz. in Plexiglass
Plexiglass Horiz. Supports
Berceaux horiz. en plexiglas

T
8*

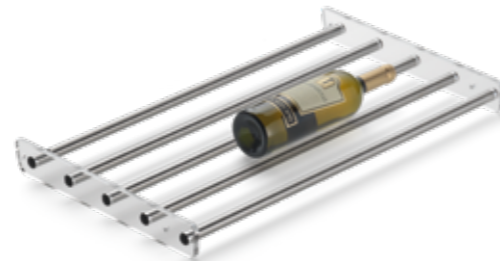

Tubi in acciaio
S. Steel Tubes
Tubes en acier

K
14*



Tubi in acciaio
S. Steel Tubes
Tubes en acier

A
28*



Tubi in acciaio inclinati
Stainless Steel Sloping Tubes
Tubes en acier inclinés

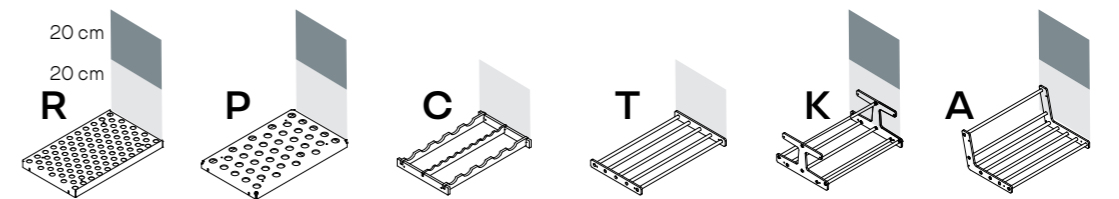

	M220430006	M020430003	GK20080010	GK20330002	GK20330006	GK20330009
	M220430008	M020430001	GK20080009	GK20330004	GK20330005	GK20330010

WINE LIBRARY

Proposte di allestimenti interni
Internal layout proposal
Agencement intérieur



Wine



			Euro (cadauno / one piece)
R	M220430006	M220430008	150
C	GK20080010	GK20080009	270
T	GK20330002	GK20330004	210
K	GK20330006	GK20330005	345
A	GK20330009	GK20330010	250
P	MO20430003	MO20430001	270
H	CC00470014		35

	R		C		RC		TRC		A		K		P		THR	
	Ripiani in acciaio (R) Stainless Steel Shelves (R) Étagères en acier (R)		Supporti orizz. in Plexiglass (C) Plexiglass Horiz. Supports (C) Berceaux horiz. en plexiglas (C)		Ripiani in acciaio (R) + Supporti orizz. in Plexiglass (C) Stainless Steel Shelves (R) + Plexiglass Horiz. Supports (C) Étagères en acier (R) + Berceaux horiz. en plexiglas (C)		Tubi (T) e ripiani (R) in acciaio + Supporti orizz. in Plexiglass (C) S. Steel Tubes (T) and Shelves (R) + Plexi Horiz. Supports (C) Tubes (T) et Berceaux (R) en acier + Berceaux horiz. en plexiglas (C)		Tubi in acciaio inclinati (A) S. Steel Sloping Tubes (A) Tubes en acier inclinés (A)		Tubi in acciaio inclinati (K) S. Steel Sloping Tubes (K) Tubes en acier inclinés (K)		Ripiani in Plexiglass (P) Plexiglass Shelves (P) Étagères en plexiglass (P)		Tubi in acciaio (T) + Gancio (H) Ripiani in acciaio (R) S. Steel Tubes (T) + Hook (H) Stainless Steel Shelves (R) Tubes en acier (T) + Crochet (H) Étagères en acier (R)	
	220 (L)	260 (H)	220 (L)	260 (H)	220 (L)	260 (H)	220 (L)	260 (H)	220 (L)	260 (H)	220 (L)	260 (H)	220 (L)	260 (H)	220 (L)	260 (H)
	168 *	210 *	80 *	100 *	124 *	166 *	98 *	140 *	112 *	140 *	56 *	70 *	non superare 20 kg not to exceed 20 kg ne pas dépasser 20 kg			
	4 x R (M220430006)	5 x R (M220430006)	8 x C (GK20080010)	10 x C (GK20080010)	4 x C (GK20080010)	4 x C (GK20080010)	4 x C (GK20080010)	4 x C (GK20080010)	4 x A (GK20330009)	5 x A (GK20330009)	4 x K (GK20330006)	5 x K (GK20330006)	4 x P (M020430003)	5 x P (M020430003)	1 x T (GK20330002)	1 x T (GK20330002)
					2 x R (M220430006)	3 x R (M220430006)	2 x T (GK20330002)	2 x T (GK20330002)							2 x R (M220430006)	2 x R (M220430006)
	4 x R (M220430008)	5 x R (M220430008)	8 x C (GK20080009)	10 x C (GK20080009)	4 x C (GK20080009)	4 x C (GK20080009)	4 x C (GK20080009)	4 x C (GK20080009)	4 x A (GK20330010)	5 x A (GK20330010)	4 x K (GK20330005)	5 x K (GK20330005)	4 x P (M020430001)	5 x P (M020430001)	1 x T (GK20330004)	1 x T (GK20330004)
					2 x R (M220430008)	3 x R (M220430008)	2 x T (GK20330004)	2 x T (GK20330004)							2 x R (M220430008)	2 x R (M220430008)

WINE LIBRARY

Dentro Wine Library c'è tutta la tecnologia Enofrigo
 Wine Library contains the best of Enofrigo technology
 La Wine Library renferme toute la technologie Enofrigo



Temperature

La refrigerazione ventilata permette di scegliere il set preferito di temperatura interna. Impostazioni da 4°C a 18°C per ciascun modulo.

Temperature

The temperature settings in this unit range from 4°C to 18°C, which can be set easily by the operator for each module.

Temperature

Le froid ventilé permet de choisir une configuration de température intérieure préférentielle. Réglages de 4°C à 18°C pour chaque module.



(optional)



Controllo digitale umidità relativa

Il controllo opzionale dell'umidità permette di mantenere un livello di umidità relativa maggiore del 50% e creare così l'ambiente ideale di conservazione del tappo della bottiglia e dell'etichetta.

Relative humidity digital control

As an option, you can control and maintain the humidity level above 50%, in order to create the perfect storage environment for bottle corks and labels.

Contrôle digital de l'humidité relative

Le contrôle optionnel de l'humidité permet de maintenir un taux d'humidité relative supérieur à 50% afin de créer un environnement idéal pour la conservation des bouchons de bouteilles ainsi que des étiquettes.



Unità indipendente di refrigerazione
 Independent refrigeration unit
 Groupe frigorifique indépendant



ECO FRIENDLY

Risparmio energetico

Bassi consumi grazie alla illuminazione a led, spessore dei montanti di 5 cm, un sistema di controllo che ottimizza l'utilizzo del sistema refrigerante e alla porta in vetro camera basso emissivo.

Energy efficient

With LED lighting, 50mm thick insulation, a 28mm thick low emissions, double-glazing glass door and a control system which improves the efficiency of the refrigeration equipment, energy consumption is quite low in this unit.

Économie d'énergie

Faible consommation grâce à l'éclairage à LED, épaisseur des montants de 5 cm, un système de contrôle pour optimiser l'utilisation du système réfrigérant et à la porte en double vitrage à faible émissivité.



Controllo da remoto (IoT)

Il controllo della macchina può avvenire da remoto utilizzando il modulo Wi-Fi opzionale e la piattaforma cloud.

Remote control (IoT)

Wine cellar can be controlled remotely using an optional Wi-Fi module and the cloud platform.

Contrôle déporté (IdO)

Le contrôle de la cave à vin se fait à distance grâce au module Wi-Fi en option et à la plateforme cloud.



Vetro interno a bassa emissività
 Low emission internal glass
 Verre à faible émissivité



WINE LIBRARY

Modello Evaporazione ventilata - Model Fan Assisted Evaporation - Modèle Évaporation ventilée

WINE LIBRARY 20 2P		Euro	
E	WINE LIBRARY 20 2P 4V H220 P60 VT E	336 A1WE2BV5*	20.960
I	WINE LIBRARY 20 2P 4V H260 P60 VT E	420 A1WE2HV5*	22.905
W	WINE LIBRARY 20 2P ISLAND H220 P60 VT I	336 A1WI2BV5*	17.605
D	WINE LIBRARY 20 2P ISLAND H260 P60 VT I	420 A1WI2HV5*	18.735
S	WINE LIBRARY 20 2P WALL H220 P60 VT W	336 A1WW2BV5*	16.105
R	WINE LIBRARY 20 2P WALL H260 P60 VT W	420 A1WW2HV5*	17.635
L	WINE LIBRARY 20 2P 3VDX H220 P60 VT D	336 A1WD2BV5*	19.410
F	WINE LIBRARY 20 2P 3VDX H260 P60 VT D	420 A1WD2HV5*	20.540
S	WINE LIBRARY 20 2P 3VSX H220 P60 VT S	336 A1WS2BV5*	19.410
R	WINE LIBRARY 20 2P 3VSX H260 P60 VT S	420 A1WS2HV5*	20.540
L	WINE LIBRARY 20 2P 2VDX H220 P60 VT R	336 A1WR2BV5*	17.920
F	WINE LIBRARY 20 2P 2VDX H260 P60 VT R	420 A1WR2HV5*	19.450
L	WINE LIBRARY 20 2P 2VSX H220 P60 VT L	336 A1WL2BV5*	17.920
F	WINE LIBRARY 20 2P 2VSX H260 P60 VT L	420 A1WL2HV5*	19.450
F	WINE LIBRARY 20 2P 3VSX-DX H220 P60 VT F	336 A1WF2BV5*	19.735
F	WINE LIBRARY 20 2P 3VSX-DX H260 P60 VT F	420 A1WF2HV5*	21.265

WINE LIBRARY 20 3P		Euro	
E	WINE LIBRARY 20 3P 4V H220 P60 VT E	504 A1WE3BV5*	28.805
I	WINE LIBRARY 20 3P 4V H260 P60 VT E	630 A1WE3HV5*	31.480
W	WINE LIBRARY 20 3P ISLAND H220 P60 VT I	504 A1WI3BV5*	26.660
D	WINE LIBRARY 20 3P ISLAND H260 P60 VT I	630 A1WI3HV5*	29.090
S	WINE LIBRARY 20 3P WALL H220 P60 VT W	504 A1WW3BV5*	23.860
R	WINE LIBRARY 20 3P WALL H260 P60 VT W	630 A1WW3HV5*	26.270
L	WINE LIBRARY 20 3P 3VDX H220 P60 VT D	504 A1WD3BV5*	28.475
F	WINE LIBRARY 20 3P 3VDX H260 P60 VT D	630 A1WD3HV5*	30.900
S	WINE LIBRARY 20 3P 3VSX H220 P60 VT S	504 A1WS3BV5*	28.475
R	WINE LIBRARY 20 3P 3VSX H260 P60 VT S	630 A1WS3HV5*	30.900
L	WINE LIBRARY 20 3P 2VDX H220 P60 VT R	504 A1WR3BV5*	25.665
F	WINE LIBRARY 20 3P 2VDX H260 P60 VT R	630 A1WR3HV5*	28.085
L	WINE LIBRARY 20 3P 2VSX H220 P60 VT L	504 A1WL3BV5*	25.665
F	WINE LIBRARY 20 3P 2VSX H260 P60 VT L	630 A1WL3HV5*	28.085
F	WINE LIBRARY 20 3P 3VSX-DX H220 P60 VT F	504 A1WF3BV5*	27.475
F	WINE LIBRARY 20 3P 3VSX-DX H260 P60 VT F	630 A1WF3HV5*	29.895



Codice - Code - Code

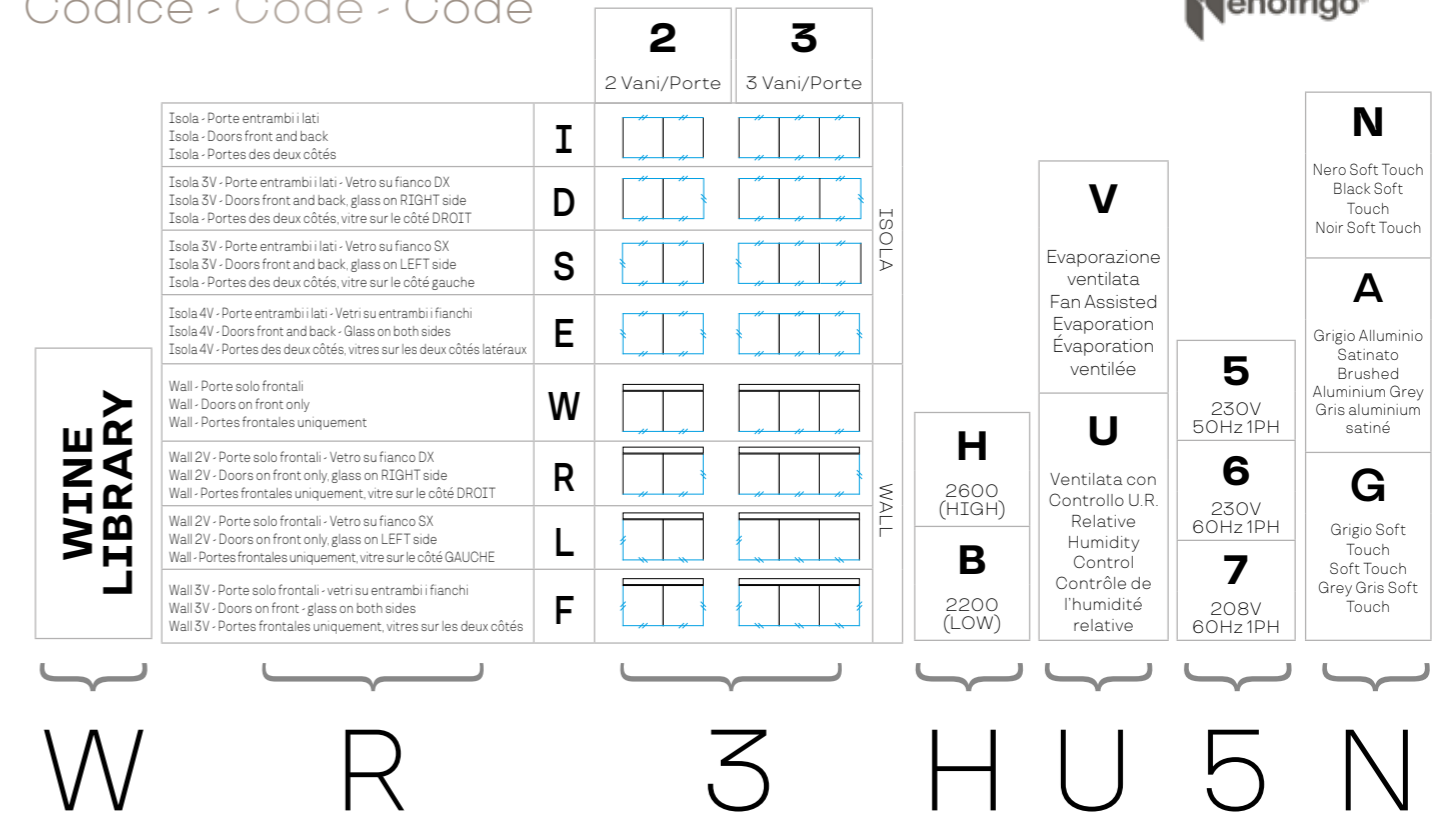

Wine Library 2020 WALL Vetro lato DX 3Porte H. 2600 VT Controllo UR 230V 50Hz Nera

Modello Ventilata con Controllo U.R. - Model Relative Humidity Control - Modèle Contrôle de l'humidité relative

WINE LIBRARY 20 2P		Euro	
E	WINE LIBRARY 20 2P 4V H220 P60 VT UR E	336 A1WE2BU5*	22.140
I	WINE LIBRARY 20 2P 4V H260 P60 VT UR E	420 A1WE2HU5*	24.100
W	WINE LIBRARY 20 2P ISLAND H220 P60 VT UR I	336 A1WI2BU5*	18.785
D	WINE LIBRARY 20 2P ISLAND H260 P60 VT UR I	420 A1WI2HU5*	19.915
S	WINE LIBRARY 20 2P WALL H220 P60 VT UR W	336 A1WW2BU5*	17.300
R	WINE LIBRARY 20 2P WALL H260 P60 VT UR W	420 A1WW2HU5*	18.830
L	WINE LIBRARY 20 2P 3VDX H220 P60 VT UR D	336 A1WD2BU5*	20.600
F	WINE LIBRARY 20 2P 3VDX H260 P60 VT UR D	420 A1WD2HU5*	21.730
S	WINE LIBRARY 20 2P 3VSX H220 P60 VT UR S	336 A1WS2BU5*	20.600
R	WINE LIBRARY 20 2P 3VSX H260 P60 VT UR S	420 A1WS2HU5*	21.730
L	WINE LIBRARY 20 2P 2VDX H220 P60 VT UR R	336 A1WR2BU5*	19.105
F	WINE LIBRARY 20 2P 2VDX H260 P60 VT UR R	420 A1WR2HU5*	20.645
L	WINE LIBRARY 20 2P 2VSX H220 P60 VT UR L	336 A1WL2BU5*	19.105
F	WINE LIBRARY 20 2P 2VSX H260 P60 VT UR L	420 A1WL2HU5*	20.645
F	WINE LIBRARY 20 2P 3VSX-DX H220 P60 VT UR F	336 A1WF2BU5*	20.915
F	WINE LIBRARY 20 2P 3VSX-DX H260 P60 VT UR F	420 A1WF2HU5*	22.445

WINE LIBRARY 20 3P		Euro	
E	WINE LIBRARY 20 3P 4V H220 P60 VT UR E	504 A1WE3BU5*	30.585
I	WINE LIBRARY 20 3P 4V H260 P60 VT UR E	630 A1WE3HU5*	33.265
W	WINE LIBRARY 20 3P ISLAND H220 P60 VT UR I	504 A1WI3BU5*	28.440
D	WINE LIBRARY 20 3P ISLAND H260 P60 VT UR I	630 A1WI3HU5*	30.870
S	WINE LIBRARY 20 3P WALL H220 P60 VT UR W	504 A1WW3BU5*	25.640
R	WINE LIBRARY 20 3P WALL H260 P60 VT UR W	630 A1WW3HU5*	28.060
L	WINE LIBRARY 20 3P 3VDX H220 P60 VT UR D	504 A1WD3BU5*	30.250
F	WINE LIBRARY 20 3P 3VDX H260 P60 VT UR D	630 A1WD3HU5*	32.685
S	WINE LIBRARY 20 3P 3VSX H220 P60 VT UR S	504 A1WS3BU5*	30.250
R	WINE LIBRARY 20 3P 3VSX H260 P60 VT UR S	630 A1WS3HU5*	32.685
L	WINE LIBRARY 20 3P 2VDX H220 P60 VT UR R	504 A1WR3BU5*	27.450
F	WINE LIBRARY 20 3P 2VDX H260 P60 VT UR R	630 A1WR3HU5*	29.865
L	WINE LIBRARY 20 3P 2VSX H220 P60 VT UR L	504 A1WL3BU5*	27.450
F	WINE LIBRARY 20 3P 2VSX H260 P60 VT UR L	630 A1WL3HU5*	29.865
F	WINE LIBRARY 20 3P 3VSX-DX H220 P60 VT UR F	504 A1WF3BU5*	29.255
F	WINE LIBRARY 20 3P 3VSX-DX H260 P60 VT UR F	630 A1WF3HU5*	31.670

OPTIONAL

Unità Remota - Remote unit - Unité à distance

Versione (WL) predisposta per remotizzazione (senza unità) per il singolo vano		Euro	
Prearranged remotable (WL) version (without condensing unit) for the single refrigerated compartment	(1P) OPT20001	-300	
Version (WL) équipée pour la gestion à distance (sans unité de condensation) de chaque compartiment			
Versione (WL) predisposta per remotizzazione (con unità fornita a parte - fino a 8 m orizzontali) per il singolo vano	(1P) OPT20002	305	
Prearranged remotable (WL) version (with condensing unit supplied separately - up to 8 m level) for the single refrigerated compartment			
Version (WL) équipée pour la gestion à distance (avec unité de condensation fournie séparément - jusqu'à 8 m horizontaux) de chaque compartiment			

OPZIONE COLORE LAMINATO SPECIALE	SPECIAL LAMINATED OPTIONAL COLOURS	OPTION COLORIS STRATIFIÉ SPÉCIAL	2P	OPT20009	1.130
OPZIONE COLORE LAMINATO SPECIALE	SPECIAL LAMINATED OPTIONAL COLOURS	OPTION COLORIS STRATIFIÉ SPÉCIAL	3P	OPT20010	1.275
LUCI LED TONALITA' FREDDA (5500-6500° K)	Cool white LED lighting (5500-6500° K)	Éclairage LED tonalité froide (5500-6500° K)	2P	OPT20016	135 NOT FOR RETROFIT
LUCI LED TONALITA' FREDDA (5500-6500° K)	Cool white LED lighting (5500-6500° K)	Éclairage LED tonalité froide (5500-6500° K)	3P	OPT20017	160 NOT FOR RETROFIT
DIMMER			2P	OPT20069	260
DIMMER			3P	OPT20070	380
RIVESTIMENTO INOX INTERNO (singolo vano)	STAINLESS STEEL INTERNAL (single compartment)	REVÊTEMENT INTERNE EN ACIER INOX (chaque compartiment)		OPT20020	1.565
KIT ILLUMINAZIONE LED RGB H220 (singola porta)	LED LIGHTING KIT, RGB H220 (single door)	KIT D'ÉCLAIRAGE À LEDS RVB H220 (porte unique)		OPT20018	570 NOT FOR RETROFIT
KIT ILLUMINAZIONE LED RGB h260 (singola porta)	LED LIGHTING KIT, RGB H260 (single door)	KIT D'ÉCLAIRAGE À LEDS RVB H260 (porte unique)		OPT20019	695 NOT FOR RETROFIT
VALVOLA ALTIMETRICA VETROCAMERA (>900 slm) per il singolo vano	DOUBLE GLAZING PRESSURE EQUALISATION VALVE (>900 m.asl) for the single refrigerated compartment	VANNE ALTIMÉTRIQUE DOUBLE VITRAGE (>900 slm) pour chaque compartiment		OPT36005	380

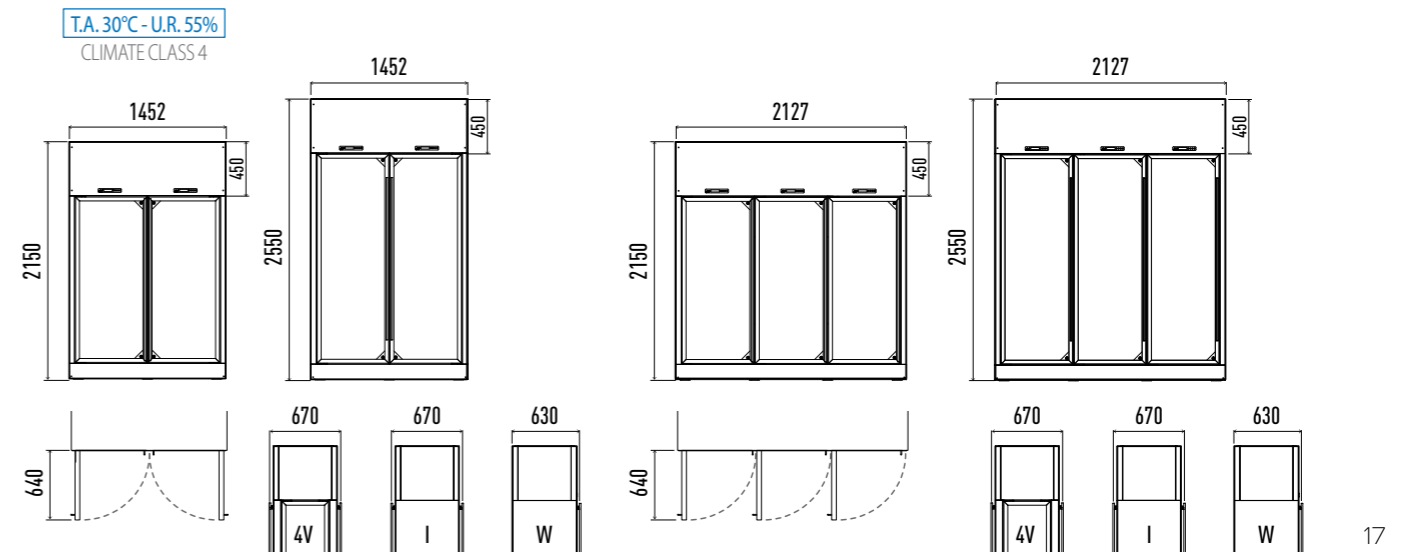



ENOGALAX

Una **dinamica** architettura di spazi modulabili all'infinito

Dynamic architecture in infinitely modular spaces

Une architecture **dynamique** d'espaces modulables à l'infini



ENOGALAX

Una **dinamica** architettura di spazi modulabili all'infinito

Dal singolo modulo alla più completa, articolata e innovativa wine room, ENOGALAX è l'espressione dell'arte della composizione espressa ai massimi livelli. Frutto della collaborazione di ENOFRIGO con un designer di fama internazionale, ENOGALAX è un sistema evoluto che coniuga tecnologia, design e flessibilità per consentire soluzioni compositive infinite.

Dynamic architecture in infinitely modular spaces

From a single module to a complete, diversified and innovative wine room, ENOGALAX is the ultimate expression of the art of composition. The result of collaboration between ENOFRIGO and an internationally famous designer, ENOGALAX is an evolved system that combines technology, design and flexibility to deliver an infinite range of modular solutions.

Une architecture **dynamique** d'espaces modulables à l'infini

Du module unique à la cave à vin la plus complète, la plus recherchée et la plus innovante, ENOGALAX est l'expression de l'art de la composition au plus haut niveau. Fruit de la collaboration d'ENOFRIGO avec un designer de renommée internationale, ENOGALAX est un système avancé qui conjugue technologie, design et flexibilité et qui offre des solutions infinies pour la réalisation de compositions.



MODULAR SYSTEM



PRACTICAL SPACE



CUSTOM INTERNAL LAYOUT

ENOGALAX

Libertà compositiva moltiplicata all'infinito

Ogni modulo viene fornito "nudo" per essere integrato in arredi esistenti o "vestito", con una ampia gamma di finiture di serie o a richiesta per abbinarsi a qualsiasi ambientazione. E se cambia l'arredamento del locale basta cambiare il vestito.

Sistema modulare

Tutti gli elementi del sistema sono dimensionati secondo una modularità che permette di realizzare un numero infinito di configurazioni adatte a ogni tipo di spazio e di esigenza di esposizione e conservazione: mono e bifacciali, con motore a bordo o remoto.

Rivestimento

La struttura del mobile è rivestita in laminati "metal" (873) o "soft touch" (720, 718).

I telai delle porte sono in alluminio anodizzato grigio o nero. Il rivestimento interno è in acciaio a specchio. Optional: è possibile scegliere altri colori per il rivestimento in laminato, ma il telaio della porta rimane anodizzato grigio o nero.

Total freedom of arrangement

Each module is offered either "naked", to be integrated in existing furnishings, or "dressed", with a wide range of serial and custom-made finishes that can suit any ambience. If the space furniture changes, all it needs is changing the dress.

Modular system

All the system elements are sized according to a modularity criterion so that it is possible to create an infinite number of configurations for any kind of space and displaying/conservation need: they can be mono and bi-facial and have on board or remote engine.

Linings

Cabinet structure covered in "metal" (873) or "soft touch" (720, 718) laminates. Door frames are in grey or black anodised aluminium. The interior linings are made in mirror-finish steel. Optional: other laminate covering colours can be specified, but door frames are available only in anodized grey or black.

Liberté de composition multipliée à l'infini

Chaque module est livré "nu" pour être intégré dans du mobilier existant ou "habillé", avec une large gamme de finitions disponibles ou sur demande pour s'adapter à tout type d'environnement. Et en cas de changement d'ameublement de la salle, il suffit de changer l'habillage.

Système modulaire

Tous les éléments du système sont dimensionnés suivant une modularité qui permet de créer une infinité de configurations s'adaptant à tout type d'espace et d'exigence en matière d'exposition et de conservation: simple et traversant, avec un moteur embarqué ou déporté.

Revêtements

La structure du meuble est habillée de stratifiés "métal" (873) ou "soft touch" (720, 718). Les châssis de portes sont en aluminium anodisé gris ou noir. Revêtement intérieur en acier miroir. Option: choix possible d'autres coloris pour le revêtement en stratifié, mais le châssis de la porte reste anodisé gris ou noir.

* Disponibile in versione monofacciale
* Available also in Wall version
* Disponible en version simple face

** Disponibile in versione bifacciale
** Available also in Pass Trough version
** Disponible en version Traversant



800
MONOFACCIALE**
SINGLE SIDE
MONO FACE



1200
BIFACCIALE*
PASS THROUGH
TRAVERSANT



1600
MONOFACCIALE**
SINGLE SIDE
MONO FACE



2000
BIFACCIALE*
PASS THROUGH
TRAVERSANT



2000
MONOFACCIALE**
SINGLE SIDE
MONO FACE



2400
BIFACCIALE*
PASS THROUGH
TRAVERSANT



873
Grigio Alluminio Satinato
Brushed Aluminium Grey
Gris aluminium satiné



718
Grigio Opaco "Soft Touch"
"Soft Touch" Matte Grey
"Soft Touch" Gris



720
Nero opaco "Soft Touch"
"Soft Touch" Matte Black
"Soft Touch" Noir

ENOGALAX

Modularità con motore remoto o vano tecnico, a voi la scelta

I moduli singoli sono predisposti per l'impianto remoto (al fine di evitare calore e rumore nell'ambiente in cui verranno inserite), oppure hanno un vano tecnico con il motore a bordo.

Choice of modules with remote motor or motor in technical compartment

Individual modules come with provision for a remote system (to avoid heat and noise in the room where they are installed), or have a technical compartment with an on-board motor.

Modularité avec moteur déporté ou compartiment technique, selon votre choix

Chacun des modules est préconfiguré pour le système de moteur déporté (afin d'éviter la chaleur et le bruit à l'endroit où ils seront insérés), ou est doté d'un compartiment technique avec moteur embarqué.





Spazio funzionale

ENOGALAX crea lo spazio e favorisce l'attività: per dividere, schermare, creare zone diverse all'interno dello stesso locale o addirittura ambienti autonomi anche di grandi dimensioni, senza bisogno di opere murarie.

Practical space

ENOGALAX creates space and favours operations: it helps dividing and screening areas, creating different zones inside the same room or even large autonomous spaces, without building walls

Un système spatial

ENOGALAX crée l'espace et favorise l'activité: pour diviser, faire écran et créer différentes zones dans une même salle ou des espaces autonomes, même de grandes dimensions, sans besoin de travaux de maçonnerie.



ENOGALAX

Mono o Bifacciale

Esposizione mono o bi facciale per la massima capacità o la migliore visibilità della bottiglia. Ogni vetrina può essere apribile da un solo lato con anta a vetri e schienale fisso cieco o a vetri (Optional), oppure con anta apribile da entrambi i lati.

Single or Pass Through

Single (Wall) or Pass through (Island) exposure for maximum capacity or better visibility of the bottle. Each display cabinet can be opened with glass doors either from one side, with a fixed back (blind or glass-topped - Optional), or from both sides.

Mono face ou Traversant

Exposition simple face ou traversant pour une capacité maximale ou pour optimiser la visibilité de la bouteille. Chaque vitrine peut être ouverte d'un seul côté avec une porte en verre et un dos fixe plein ou en verre (en option), ou encore avec une porte permettant une ouverture des deux côtés.

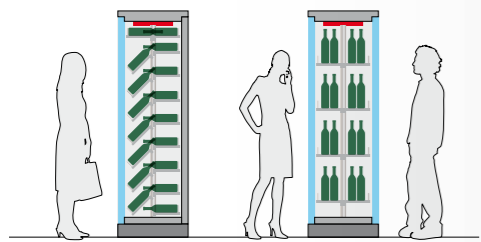

PRACTICAL
SPACE



ENOGALAX

Il sistema dei ripiani

Il sistema dei ripiani consente una totale flessibilità e libertà espositiva. L'utente può configurare la composizione che preferisce, privilegiando la massima capienza o la visibilità ottimale.

The shelf system

The shelf system permits great flexibility and adapts to different exhibition displays. Users can choose their preferred composition, favouring either capacity or visibility.

Le système d'étagères

Le système d'étagères permet une flexibilité totale et une liberté d'exposition. L'utilisateur peut configurer la composition de son choix, en prenant le parti d'optimiser la capacité ou de privilégier une visibilité maximale.

Ripiani facilmente estraibili per una completa pulizia (anche in lavastoviglie)

Fully removable shelves for easy cleaning (dishwasher compatible)

Étagères facilement amovibles pour un nettoyage complet (également en lave-vaisselle)



CUSTOM
INTERNAL
LAYOUT

Più spazio

La totale assenza all'interno del vano bottiglie di elementi d'ingombro garantiscono la massima capienza favorendo una maggiore funzionalità, praticità e facilità d'accesso ai prodotti.

More space

The absence of devices that protrude into the bottle compartment permit full use of available space, maximise functionality and practicality and ensure easy access to contents.

Plus d'espace

L'absence totale d'éléments encombrants dans le compartiment à bouteilles garantissent plus de fonctionnalité, et permettent d'accéder aux produits de façon simple et pratique.

I ripiani in quarzo e acciaio inox sono reclinabili in due posizioni.

Quartz and stainless steel shelves can be fitted sloping in two positions.

Les étagères en quartz et en acier inoxydable peuvent être inclinées dans deux positions.



0°

22,5°

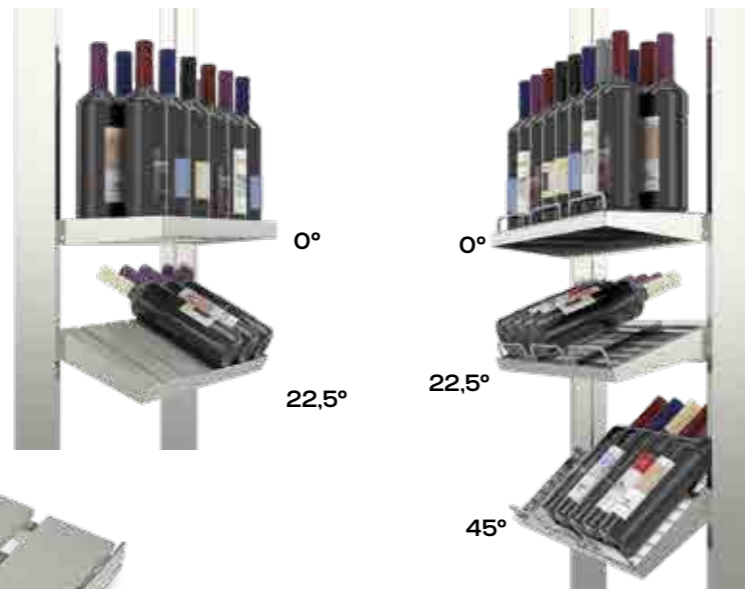

0°

22,5°

45°

I ripiani in polycarbonato e acciaio inox sono posizionabili a diverse altezze e reclinabili, è sufficiente spostare le viti con cui sono fissate alla barra centrale.

Shelves made in polycarbonate and stainless steel can be positioned at different heights and they can be reclinated.

Les étagères en polycarbonate et acier inoxydable sont réglables à différentes hauteurs et inclinables; pour cela, il suffit de déplacer les vis qui sont fixées à la barre centrale.



Illuminazione a LED (2700°K) integrata
Integrated LED lightning (2700°K)
Éclairage à LED intégré (2700°K)

ENOGALAX

Dentro Enogalax c'è tutta la tecnologia Enofrigo
Enogalax contains the best of Enofrigo technology
La Enogalax renferme toute la technologie Enofrigo



Temperature

La refrigerazione ventilata permette di scegliere il set preferito di temperatura interna. Impostazioni da 4°C a 18°C per ciascun modulo.

Temperature

The temperature settings in this unit range from 4°C to 18°C, which can be set easily by the operator for each module.

Temperature

Le froid ventilé permet de choisir une configuration de température intérieure préférentielle. Réglages de 4°C à 18°C pour chaque module.



(optional)

Controllo digitale umidità relativa

Il controllo opzionale dell'umidità permette di mantenere un livello di umidità relativa maggiore del 50% e creare così l'ambiente ideale di conservazione del tappo della bottiglia e dell'etichetta.

Relative humidity digital control

As an option, you can control and maintain the humidity level above 50%, in order to create the perfect storage environment for bottle corks and labels.

Contrôle digital de l'humidité relative

Le contrôle optionnel de l'humidité permet de maintenir un taux d'humidité relative supérieur à 50% afin de créer un environnement idéal pour la conservation des bouchons de bouteilles ainsi que des étiquettes.



Controllo da remoto (IoT)

Il controllo della macchina può avvenire da remoto utilizzando il modulo Wi-Fi opzionale e la piattaforma cloud.

Remote control (IoT)

Wine cellar can be controlled remotely using an optional Wi-Fi module and the cloud platform.

Contrôle déporté (IdO)

Le contrôle de la cave à vin se fait à distance grâce au module Wi-Fi en option et à la plateforme cloud.

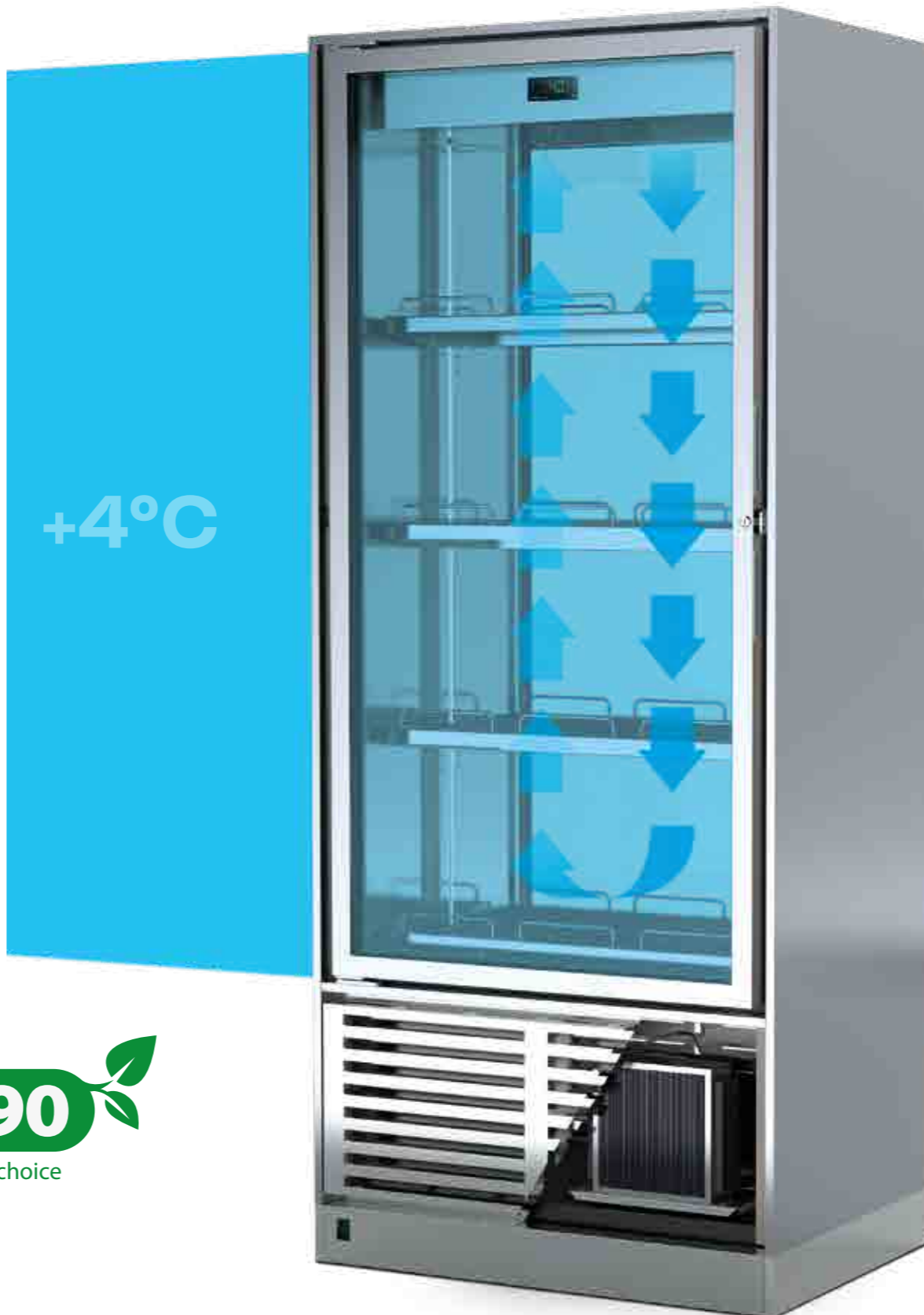
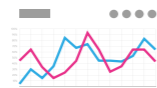

Vetro interno a bassa emissività
Low emission internal glass
Verre à faible émissivité



ECO FRIENDLY

Risparmio energetico

Bassi consumi grazie alla illuminazione a led, spessore dei montanti di 5 cm, un sistema di controllo che ottimizza l'utilizzo del sistema refrigerante e alla porta in vetro camera basso emissivo.

Energy efficient

With LED lighting, 50mm thick insulation, a 28mm thick low emissions, double-glazing glass door and a control system which improves the efficiency of the refrigeration equipment, energy consumption is quite low in this unit.

Économie d'énergie

Faible consommation grâce à l'éclairage à LED, épaisseur des montants de 5 cm, un système de contrôle pour optimiser l'utilisation du système réfrigérant et à la porte en double vitrage à faible émissivité.

Unità indipendente di refrigerazione
Independent refrigeration unit
Groupe frigorifique indépendant

ENOGALAX

Moduli singoli motore a bordo / predisposti per la remotizzazione
 Individual modules with on-board motor / provision for remote motor
 Modules individuels à moteur embarqué / équipés pour la gestion à distance

+4° +18° T.A. 30°C - U.R. 55% CLIMATE CLASS 4		Door	Evaporation	Shel- ves	Humi- dity control	Capacity (Liters)	(UP TO)	Code	Euro	Remoto - Remote - Déporté	senza motore con valvola without motor, valve included sans moteur avec vanne	con motore scollegato con valvola with disconnected motor, valve included avec moteur débranché avec vanne	Altri colori - Other Colours - Autres coloris	Ripiani in quarzo e acciaio Shelves in quartz and stainless steel Étagères en agglomérat et acier
H800 Monofacciale - Single side - Mono face														
	DOOR H800	FAN ASSISTED	3	181	68	GM1C1V	6.680							
	DOOR H800	FAN ASSISTED	3	•	181	68	GM1C1U	7.610						
H1200 Monofacciale - Single side - Mono face														
	DOOR H800	FAN ASSISTED	4	228	68	GM2C1V	8.005							
	DOOR H800	FAN ASSISTED	4	•	228	68	GM2C1U	8.930						
H1600 Monofacciale - Single side - Mono face														
	DOOR H1600	FAN ASSISTED	7	456	167	GM3C1V	8.515							
	DOOR H1600	FAN ASSISTED	7	•	456	167	GM3C1U	9.435						
H2000 Monofacciale - Single side - Mono face														
	DOOR H1600	FAN ASSISTED	8	517	192	GM4C1V	9.920							
	DOOR H1600	FAN ASSISTED	8	•	517	192	GM4C1U	10.710						
H2000 Monofacciale - Single side - Mono face														
	DOOR H2000	FAN ASSISTED	9	583	215	GM5C1V	9.640							
	DOOR H2000	FAN ASSISTED	9	•	583	215	GM5C1U	10.725						
H2400 Monofacciale - Single side - Mono face ▲														
	DOOR H2000	FAN ASSISTED	10	650	240	GM6C1V	10.845							
	DOOR H2000	FAN ASSISTED	10	•	650	240	GM6C1U	11.875						

NOTE: • Controllo umidità relativa (U.R. 50%-70%) - Relative humidity digital control (R.H. 50%-70%) - Contrôle de l'humidité relative (H.R. 50%-70%)
 ▲ Trasporto vedi pag.109 - Packaging see p. 109 - Transport p.109

+4° +18° T.A. 30°C - U.R. 55% CLIMATE CLASS 4		Door	Evaporation	Shel- ves	Humi- dity control	Capacity (Liters)	(UP TO)	Code	Euro	Remoto con motore scollegato con valvola Remote with disconnected motor, valve included Déporté avec moteur débranché avec vanne	Altri colori - Other Colours - Autres coloris	Ripiani in quarzo e acciaio Shelves in quartz and stainless steel Étagères en agglomérat et acier
H800 Bifacciale - Pass through - Traversant												
	DOOR H800	FAN ASSISTED	4	228	68	GB1*1V	8.110					
	DOOR H800	FAN ASSISTED	4	•	228	68	GB1*1U	8.795				
H1200 Bifacciale - Pass through - Traversant												
	DOOR H800	FAN ASSISTED	4	228	68	GB2C1V	8.780					
	DOOR H800	FAN ASSISTED	4	•	228	68	GB2C1U	9.700				
H1600 Bifacciale - Pass through - Traversant												
	DOOR H1600	FAN ASSISTED	8	517	192	GB3*1V	9.870					
	DOOR H1600	FAN ASSISTED	8	•	517	192	GB3*1U	10.800				
H2000 Bifacciale - Pass through - Traversant												
	DOOR H1600	FAN ASSISTED	8	517	192	GB4C1V	10.690					
	DOOR H1600	FAN ASSISTED	8	•	517	192	GB4C1U	11.615				
H2000 Bifacciale - Pass through - Traversant												
	DOOR H2000	FAN ASSISTED	10	650	240	GB5*1V	10.965					
	DOOR H2000	FAN ASSISTED	10	•	650	240	GB5*1U	12.035				
H2400 Bifacciale - Pass through - Traversant ▲												
	DOOR H2000	FAN ASSISTED	10	650	240	GB6C1V	11.770					
	DOOR H2000	FAN ASSISTED	10	•	650	240	GB6C1U	12.855				

NOTE: disponibile anche con lato vetrato bloccato, senza serratura - also available with fixed glass side, without lock - Également disponible avec côté vitré bloqué, sans serrure
 * GAS Refrigerante - Refrigerating GAS - GAZ réfrigérant (pag. 8 e pag. 111)

OPTIONAL

	Code	Euro
OPZIONE COLORE LAMINATO SPECIALE - SPECIAL LAMINATED OPTIONAL COLOURS - OPTION COLORIS STRATI-FIÉ SPÉCIAL H800-H1200	OPT87002	650
OPZIONE COLORE LAMINATO SPECIALE - SPECIAL LAMINATED OPTIONAL COLOURS - OPTION COLORIS STRATI-FIÉ SPÉCIAL H1600	OPT87003	785
OPZIONE COLORE LAMINATO SPECIALE - SPECIAL LAMINATED OPTIONAL COLOURS - OPTION COLORIS STRATI-FIÉ SPÉCIAL H2000-H2400	OPT87004	910
VALVOLA ALTIMETRICA VETROCAMERA - DOUBLE GLAZING PRESSURE EQUALISATION VALVE - VANNE AL-TIMÉTRIQUE DOUBLE VITRAGE (>900 slm)	OPT36005	380
DIMMER	OPT87006	160 NOT FOR RETROFIT
RIPIANO SINGOLO - SINGLE SHELF - ÉTAGÈRE SIMPLE	GA87430009R	170
RIPIANO SINGOLO CON PIASTRE "QUARZO"- SINGLE SHELF WITH "QUARZO" INSERTS	GA87430011	380
CASSETTO ESTRAIBILE COMPLETO DI CULLE - REMOVABLE DRAWER WITH HORIZ. SUPPORTS	GA87210001R	355
KIT ILLUMINAZIONE LED RGB (singola porta) - LED LIGHTING KIT, RGB (single door) - KIT D'ÉCLAIRAGE À LEDS RVB (porte unique)	OPT87009	455 H800/H1200
KIT ILLUMINAZIONE LED RGB (singola porta) - LED LIGHTING KIT, RGB (single door) - KIT D'ÉCLAIRAGE À LEDS RVB (porte unique)	OPT20018	570 H1600
KIT ILLUMINAZIONE LED RGB (singola porta) - LED LIGHTING KIT, RGB (single door) - KIT D'ÉCLAIRAGE À LEDS RVB (porte unique)	OPT20019	695 H2000
KIT VASCHETTA SCIOGLICONDENSA - CONDENSATE TRAY	OPT87011	350



GA87430009R

NON SUPERARE 30 kg - NOT TO EXCEED 30 kg - NE PAS DÉPASSER 30kg



GA87430011

NON SUPERARE 30 kg - NOT TO EXCEED 30 kg - NE PAS DÉPASSER 30kg



GA87210001

Codice
Code
Code

ENOGALAX	M Monofacciale con ripiani interni dritti Wall - Flat Internal Layout Simple face avec étagères intérieures droites	B Bifacciale con ripiani interni dritti Pass Through - Flat Internal Layout Traversant avec étagères intérieures droites	1 Vetrina/Cabinet/Vitrine H.800 Porta/ Door/ Porte H.800	C Motore a bordo gas R290 Self Contained gas R290 Moteur embarqué R290	REMOTO/REMOTE	P Remoto gas R452a Remote gas R452a Déporté gas R452a	1 Maniglia su lato destro Handle on Right Side Poignée sur le côté droit	2 Maniglia su lato sinistro Handle on Left Side Poignée sur le côté gauche	V Evaporazione ventilata Fan Assisted Evaporation Évaporation ventilée	U Controllo umidità relativa Relative Humidity Control Contrôle de l'humidité relative	Colori laminato Laminate Colors Coloris stratifié	Cover di rivestimento External Cover Habillage
			2 Vetrina/Cabinet/Vitrine H.1200 Porta/ Door/ Porte H.800									
			3 Vetrina/Cabinet/Vitrine H.1600 Porta/ Door/ Porte H.1600									
			4 Vetrina/Cabinet/Vitrine H.2000 Porta/ Door/ Porte H.1600									
			5 Vetrina/Cabinet/Vitrine H.2000 Porta/ Door/ Porte H.2000									
			6 Vetrina/Cabinet/Vitrine H.2400 Porta/ Door/ Porte H.2000									

G M 2 A 1 V (Col./Cov.)

ENOGALAX MONOFACCIALE H1200 DOOR H800 MOT R134 EVAP VENT 4 SHELVES

Esempi di composizioni con motore remoto
Examples of configurations with remote motor
Exemples de compositions avec moteur déporté

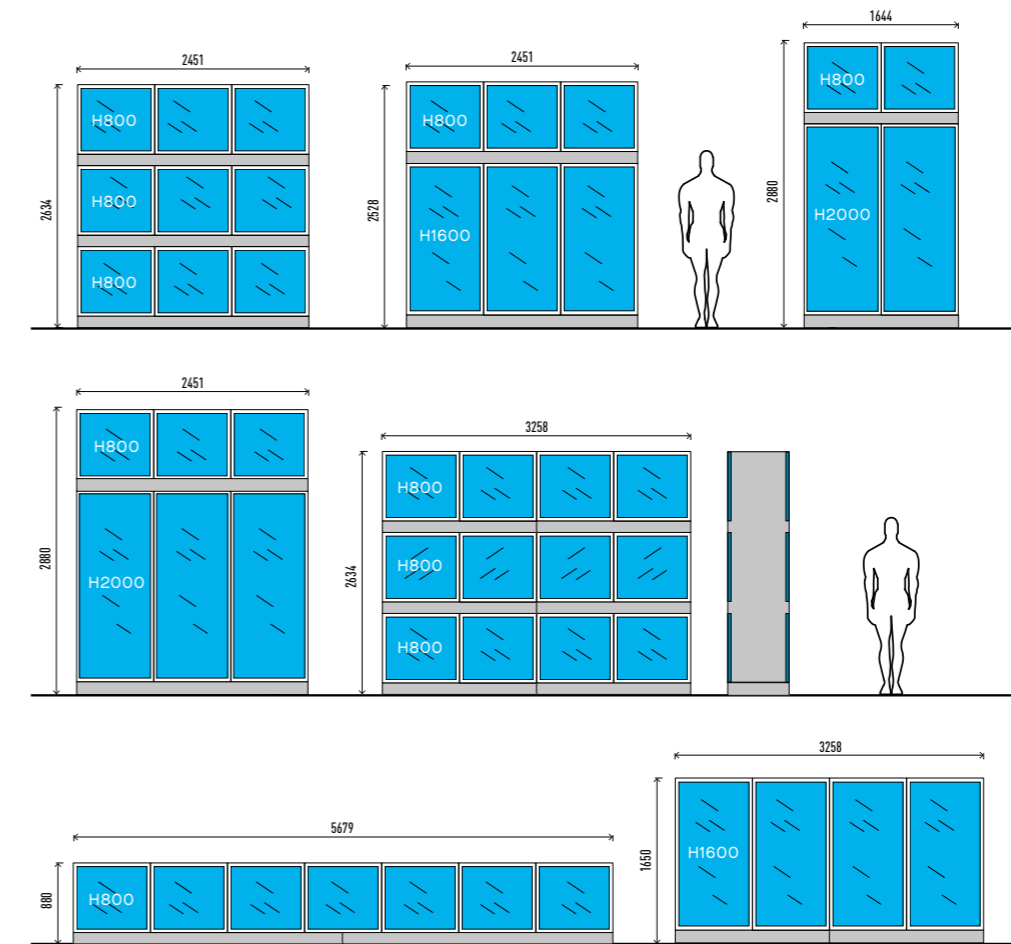

LEGENDA

Vano espositivo
Display compartment
Compartment d'exposition

Vano tecnico
Motor compartment
Compartment technique

Zoccolo
Base
Socle

Esempi di composizioni con vano tecnico
Examples of configurations with motor compartment
Exemples de compositions avec compartiment technique

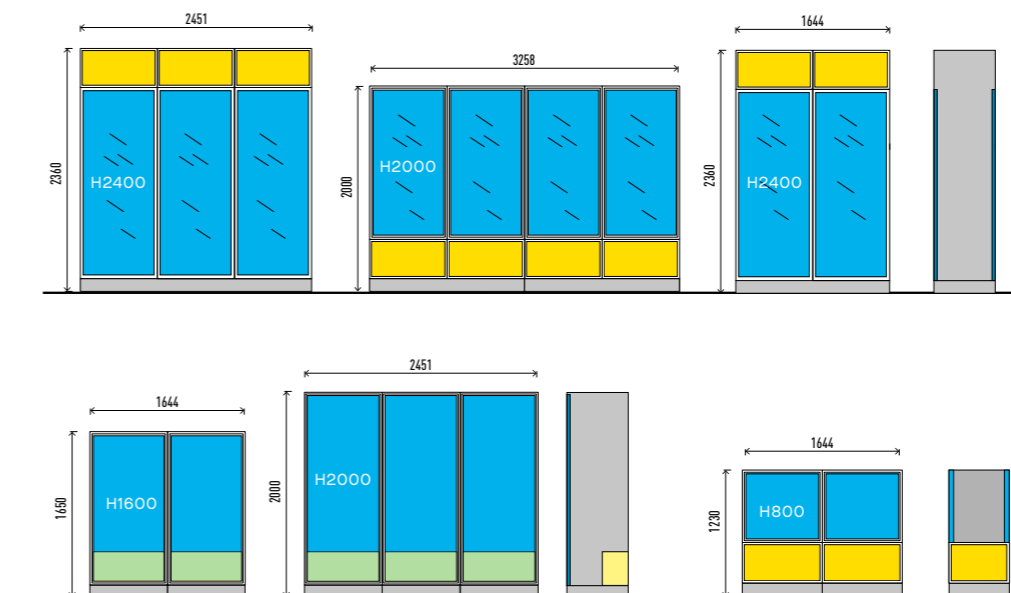

ENOGALAX MEAT

Occhi puntati
sui tuoi ingredienti

Eyes on your
ingredients

Les yeux rivés
sur vos produits

ENOGALAX MEAT

Valorizza la carne e ingolosisci i clienti

Enogalax Meat è una vetrina refrigerata studiata per esporre al meglio i tagli di carne all'interno dei locali. Puoi scegliere la temperatura interna che preferisci, a partire da 2°C*, controllarla elettronicamente e mantenere nelle condizioni ideali la carne migliore fino a un massimo di 5 giorni, senza alterazioni organolettiche rilevanti.

Luci interne e ripiani di inox o quarzo ne esaltano colore e aspetto e il sistema di controllo dell'umidità relativa permette di preservarne il peso. I clienti saranno spinti ad acquistare più del solito.

*per lo standard di classe climatica 4

Add value to your meat and make your customers' mouths water!

Enogalax Meat is a refrigerated cabinet designed especially for displaying cuts of meat in catering businesses. You can set the temperature you want, starting from 2°C*, control it electronically, and maintain ideal meat display conditions for up to 5 days without any significant alteration to organoleptic properties. Internal lighting and stainless-steel or quartz shelves enhance colour and appearance while a relative humidity control system prevents weight loss. Your customers will order more as a result.

*for climate class 4 standard.

Mettez la viande en valeur et vos clients en appétit

Enogalax Meat est une vitrine réfrigérée conçue pour optimiser l'exposition des pièces de viande dans votre établissement. Vous pouvez régler la température interne de votre choix, à partir de 2 °C*, la contrôler électroniquement et préserver la qualité de la viande dans des conditions idéales jusqu'à 5 jours, sans modifications organoleptiques significatives. L'éclairage intérieur et les étagères en acier inoxydable ou en quartz rehaussent sa couleur et son aspect et son poids reste inchangé grâce au système de contrôle de l'humidité relative. Les clients auront envie de se laisser tenter, plus qu'à l'accoutumée.

*pour la classe climatique 4.



EYE CATCHING



MEAT ENHANCER



MODULAR SYSTEM



enofrigo®



MEAT ♥ WINE

Abbina Enogalax Wine ed Enogalax Meat e cattura l'attenzione dei tuoi clienti mostrando al meglio vini e carne.

Combine Enogalax Wine and Enogalax Meat and draw your guests' attention by displaying both products in the best possible conditions.

Associez Enogalax Wine et Enogalax Meat et captez l'attention de vos clients en leur proposant une exposition optimale de vos vins et de vos viandes.



ENOGALAX MEAT

Preserva peso e morbidezza della carne

Grazie al sistema di controllo digitale dell'umidità relativa, Enogalax Meat mantiene sempre un livello di umidità interna ideale. In questo modo, il peso dei tagli rimane praticamente inalterato. Sei sicuro di salvaguardare al massimo la morbidezza della carne e tutto il suo valore commerciale?

Conserve the weight and tenderness of your meat

Thanks to a digital relative humidity control system, Enogalax Meat maintains the perfect humidity conditions inside the display. The weight of your cuts therefore remains virtually constant. And by safeguarding the tenderness of your meat, you also maintain its commercial value.

Préservez le poids et la tendreté de la viande

Grâce au système de contrôle numérique de l'humidité relative, Enogalax Meat maintient toujours un niveau d'humidité interne idéal. De cette façon, le poids des pièces de viande reste pratiquement inchangé. Vous êtes sûr de préserver au maximum la tendreté de la viande et toute sa valeur commerciale.



MEAT
ENHANCER



100% sicuro per la salute

Il sistema controllato di led UV-C, attivato in assenza di carne all'interno della cella, si occupa della perfetta sanificazione preliminare dei vani. Per la massima sicurezza, il sistema di illuminazione esclude il funzionamento degli UV-C quando è in funzione il frigo compressore. I ripiani in inox facilitano la pulizia.

100% safe for health

A controlled UV-C LED system activates in the absence of meat in the display and performs an effective preliminary sanitisation of all compartments. For maximum food safety, the lighting control system disables the UV-C lights whenever the refrigeration system is functioning. Shelves are made from stainless steel for easy cleaning.

100% sûr pour la santé

Le système à LED UV-C contrôlé, activé en l'absence de viande à l'intérieur de la cellule, assure un assainissement préalable parfait des compartiments. Pour une sécurité maximale, le système d'éclairage exclut le fonctionnement des UV-C lorsque le frigo compresseur est en marche. Les étagères en acier inoxydable facilitent le nettoyage.



Valorizzazione cromatica della carne

Il viraggio cromatico dei led interni è studiato per far risaltare il colore invitante della carne e garantire un'esposizione d'effetto.

Enhanced meat colour

The hue of the interior lighting LEDs is chosen to make the colour of the meat particularly inviting and to guarantee effective presentation.

Mise en valeur de la couleur de la viande

Le changement de couleur des LED internes est conçu pour faire ressortir la couleur invitante de la viande exposée et garantir un impact visuel direct.



Ripiani in quarzo effetto marmo (OPTIONAL)

I ripiani opzionali in agglomerato effetto marmo richiamano l'estetica delle antiche macellerie tradizionali. Sono facilmente estraibili per semplificare le operazioni di pulizia.

Marble-look quartz shelves (OPTIONAL)

Optional shelves in marble-look agglomerate recall the look and feel of traditional butchers' shops. Shelves are easily removed for simpler cleaning.

Étagères en quartz effet marbre - EN OPTION

Les étagères en aggloméré effet marbre, en option, rappellent l'esthétique des boucheries traditionnelles. Elles sont facilement amovibles pour faciliter le nettoyage.

ENOGALAX MEAT

Sistema modulare

Con gli elementi del sistema puoi realizzare un numero infinito di combinazioni e configurazioni, adatte a ogni spazio e a ogni esigenza di esposizione. Enogalax Meat è mono e bifacciale, con motore a bordo o remoto. Affiancandolo ad altri elementi della linea Enogalax Wine, ottieni un angolo esteticamente armonioso e d'impatto dove esporre, vicini, carne e vini.

Modular system

The various elements of the system permit innumerable different configurations to suit all spaces and display needs. Enogalax Meat can be single or double sided, and with an on-board or remote motor. Installing Enogalax Meat and Enogalax Wine displays together creates a harmonious and attractive corner for displaying both products together.

Système modulaire

Avec les éléments du système, vous pouvez créer un nombre infini de combinaisons et de configurations, adaptées à chaque espace et à chaque besoin d'exposition: Enogalax Meat est proposé en simple et double face, avec moteur embarqué ou à distance. Associez-le à d'autres éléments de la gamme Enogalax Wine pour créer un espace esthétiquement harmonieux à fort impact visuel pour exposer, côte à côte, les viandes et les vins.

Rivestimento

La struttura del mobile è rivestita in laminato "metal" (873) o disponibile in due versioni cromatiche dello smart material "soft touch" (720, 718), per un effetto sofisticato e piacevole al tatto e una particolare resistenza ai graffi superficiali. I telai delle porte sono in alluminio anodizzato grigio o nero. Il rivestimento interno è in acciaio a specchio. Su richiesta, puoi scegliere altri colori opzionali per il rivestimento in laminato (il telaio della porta rimane in alluminio anodizzato grigio o nero).

Coverings

The cabinet frame is normally covered in a "metal" laminate (873), but is also available in two different colour versions of smart "soft touch" material (720, 718) for a pleasingly sophisticated look and feel and excellent scratch resistance. Door frames are in grey or black anodised aluminium. The display interior is lined in mirror-finish stainless steel. On request, you can also specify other laminate covering colours (but door frames are available only in anodised grey or black).

Revêtement

La structure du meuble est recouverte d'un stratifié « métal » (873) ou disponible en deux versions de couleur du matériau intelligent « soft touch » (720, 718), pour un effet sophistiqué et agréable au toucher et particulièrement résistant aux rayures de surface. Les châssis des portes sont en aluminium anodisé gris ou noir. Le revêtement intérieur est en acier miroir. Vous pouvez faire le choix d'autres coloris pour le revêtement en stratifié sur demande (le châssis de la porte reste en aluminium anodisé gris ou noir).

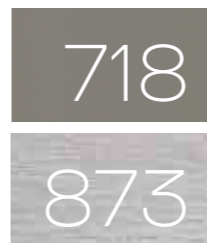

718
Grigio Opaco "Soft Touch"
"Soft Touch" Matte Grey
"Soft Touch" Gris

873
Grigio Alluminio Satinato
Brushed Aluminium Grey
Gris aluminium satiné



720
Nero opaco "Soft Touch"
"Soft Touch" Matte Black
"Soft Touch" Noir

2400
BIFACCIALE*
PASS THROUGH
TRAVERSANT

2000
BIFACCIALE*
PASS THROUGH
TRAVERSANT

2000
MONOFACCIALE**
SINGLE SIDE
MONO FACE

1600
MONOFACCIALE**
SINGLE SIDE
MONO FACE

1200
BIFACCIALE*
PASS THROUGH
TRAVERSANT

800
MONOFACCIALE**
SINGLE SIDE
MONO FACE



* Disponibile in versione monofacciale
* Available also in Wall version
* Disponible en version simple face

** Disponibile in versione bifacciale
** Available also in Pass Trough version
** Disponible en version Traversant

ENOGALAX MEAT



Tutta la tecnologia Enofrigo per una perfetta esposizione della carne
The best of Enofrigo technology for perfect meat displays
Toute la technologie Enofrigo pour une exposition parfaite de la viande



ECO FRIENDLY

Performance di massimo livello

Enogalax raggiunge una temperatura interna di +2°C anche in condizioni particolari (per esempio, con un ambiente esterno molto caldo). Il controllo digitale dell'umidità mantiene un livello di umidità relativa maggiore del 50% e crea così l'ambiente ideale per una conservazione breve della carne (max 5gg).

Unrivalled performance

Enogalax maintains an internal temperature of +2°C even in challenging conditions (e.g. with high outside temperature). Digital control ensures that relative humidity always remains over 50%, creating the ideal environment for short-term meat display (max 5 days).

Performances de très haut niveau

Enogalax atteint une température interne de +2 °C même dans des conditions particulières (par exemple, un environnement extérieur très chaud). Le contrôle numérique de l'humidité maintient un taux d'humidité relative de plus de 50 % et crée ainsi l'environnement idéal pour une conservation à court terme de la viande (5 jours maximum).

Gas refrigerante naturale

Per il ciclo frigorifero, Enogalax Meat impiega il gas refrigerante naturale R290, un'alternativa ecologica e sicura rispetto ai refrigeranti più comuni. Completamente atossico, è apprezzato per le sue eccellenti proprietà termodinamiche: assicura alte prestazioni e lunga durata e dimostra una grande efficienza con un minor consumo di energia e un impatto ambientale praticamente nullo.

Natural refrigerant

Enogalax Meat uses R290 refrigerant, a natural, ecological and safe alternative to common refrigerants. R290 is completely non-toxic and is acclaimed for its excellent thermodynamic characteristics. High-performance and long lasting, it is also extremely efficient, reduces energy consumption and has virtually zero impact on the environment.

Gaz réfrigérant naturel

Pour le cycle de réfrigération, Enogalax Meat utilise le gaz réfrigérant naturel R290, une alternative écologique et sûre aux réfrigérants plus courants. Entièrement non toxique, il est apprécié pour ses excellentes propriétés thermodynamiques : il garantit des performances élevées et une longue durée de vie et fait preuve d'une grande efficacité avec une consommation d'énergie réduite et un impact environnemental pratiquement nul.

Risparmio energetico

Bassi consumi grazie alla illuminazione a led, spessore dei montanti di 5 cm, un sistema di controllo che ottimizza l'utilizzo del sistema refrigerante e alla porta in vetro camera basso emissivo.

Energy saving

Enogalax Meat displays use very little energy thanks to LED lighting, thick pillars (5 cm), a controller that optimises the effectiveness of the refrigeration system, and a low-emissivity double-glazed door.

Économie d'énergie

La consommation d'Enogalax Meat est extrêmement faible grâce à son éclairage à LED, à la forte épaisseur des montants (5 cm), au système de contrôle qui optimise l'utilisation du système de réfrigération et à la porte à double vitrage à faible émissivité.

OPTIONAL

	Code	Euro
OPZIONE COLORE LAMINATO SPECIALE - SPECIAL LAMINATED OPTIONAL COLOURS - OPTION COLORIS STRATIFIÉ SPÉCIAL H800-H1200	OPT87002	650
OPZIONE COLORE LAMINATO SPECIALE - SPECIAL LAMINATED OPTIONAL COLOURS - OPTION COLORIS STRATIFIÉ SPÉCIAL H1600	OPT87003	785
OPZIONE COLORE LAMINATO SPECIALE - SPECIAL LAMINATED OPTIONAL COLOURS - OPTION COLORIS STRATIFIÉ SPÉCIAL H2000-H2400	OPT87004	910
RIPIANO SINGOLO CON PIASTRE "QUARZO"- SINGLE SHELF WITH "QUARZO" INSERTS	GA87430011R	380
KIT BARRE COMPLETE FORATE CON OPALINA (H800)	OPT87010	205
KIT VASCHETTA SCIOGLICONDENSA - CONDENSATE TRAY	OPT87011	350

GA87430011R



Grigio - Gray - Gris

GA87430011R



Nero - Black - Noir

GA87430011R



Neutro - Neutral - Neutre

Codice - Code - Code

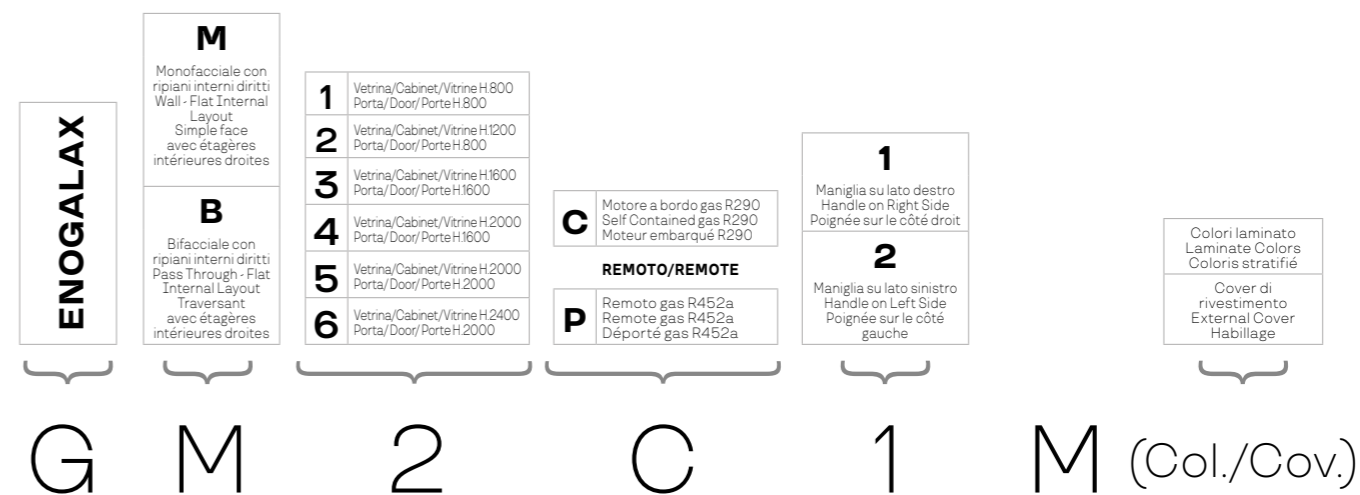





ENOGALAX MEAT MONOFACCIALE H1200 DOOR H800 MOT R290

ENOGALAX MEAT



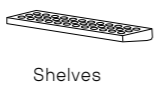

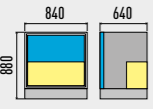
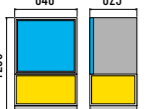
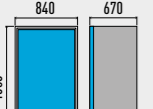
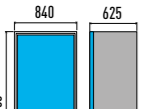
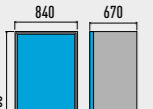
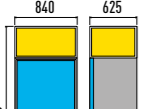

Monofacciale - Single side - Mono face



On Board	Remote	 			Code	Euro		Altri colori - Other Colours - Autres coloris	Ripiani in quarzo e acciaio - Shelves in quartz and stainless steel - Étagères en agglomérat et acier
H800 Monofacciale - Single side - Mono face									
					DOOR H800 MOT MAN DX	3	181	GM1C1M	7.870
					DOOR H800 MOT MAN SX	3	181	GM1C2M	7.870
					DOOR H800 REM MAN DX	4	181	GM1P1M	7.710
					DOOR H800 REM MAN SX	4	181	GM1P2M	7.710
H1200 Monofacciale - Single side - Mono face									
					DOOR H800 MOT MAN DX	4	228	GM2C1M	9.205
					DOOR H800 MOT MAN SX	4	228	GM2C1M	9.205
H1600 Monofacciale - Single side - Mono face									
					DOOR H1600 MOT MAN DX	7	456	GM3C1M	9.700
					DOOR H1600 MOT MAN SX	7	456	GM3C2M	9.700
					DOOR H1600 REM MAN DX	8	456	GM3P1M	9.535
					DOOR H1600 REM MAN SX	8	456	GM3P2M	9.535
H2000 Monofacciale - Single side - Mono face									
					DOOR H1600 MOT MAN DX	8	517	GM4C1M	10.980
					DOOR H1600 MOT MAN SX	8	517	GM4C1M	10.980
H2000 Monofacciale - Single side - Mono face									
					DOOR H2000 MOT MAN DX	9	583	GM5C1M	10.985
					DOOR H2000 MOT MAN SX	9	583	GM5C2M	10.985
					DOOR H2000 REM MAN DX	10	583	GM5P1M	10.825
					DOOR H2000 REM MAN SX	10	583	GM5P2M	10.825
H2400 Monofacciale - Single side - Mono face ▲									
					DOOR H2000 MOT MAN DX	10	650	GM6C1M	12.140
					DOOR H2000 MOT MAN SX	10	650	GM6C1M	12.140

Bifacciale - Pass through - Traversant

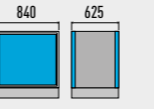

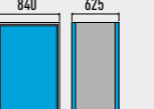
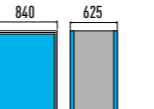
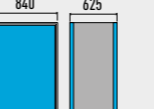
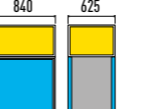
On Board	Remote	 			Code	Euro		Altri colori - Other Colours - Autres coloris	Ripiani in quarzo e acciaio - Shelves in quartz and stainless steel - Étagères en agglomérat et acier
H800 Bifacciale - Pass through - Traversant									
					DOOR H800 REM MAN DX	4	228	GB1P1M	9.060
					DOOR H800 REM MAN SX	4	228	GB1P2M	9.060
H1200 Bifacciale - Pass through - Traversant									
					DOOR H800 MOT MAN DX	4	228	GB2C1M	9.970
					DOOR H800 MOT MAN SX	4	228	GB2C2M	9.970
H1600 Bifacciale - Pass through - Traversant									
					DOOR H1600 REM MAN DX	8	517	GB3P1M	11.065
					DOOR H1600 REM MAN SX	8	517	GB3P2M	11.065
H2000 Bifacciale - Pass through - Traversant									
					DOOR H1600 MOT MAN DX	8	517	GB4C1M	11.885
					DOOR H1600 MOT MAN SX	8	517	GB4C2M	11.885
H2000 Bifacciale - Pass through - Traversant									
					DOOR H2000 REM MAN DX	10	650	GB5P1M	12.300
					DOOR H2000 REM MAN SX	10	650	GB5P2M	12.300
H2400 Bifacciale - Pass through - Traversant ▲									
					DOOR H2000 MOT MAN DX	10	650	GB6C1M	13.120
					DOOR H2000 MOT MAN SX	10	650	GB6C2M	13.120

NOTE: disponibile anche con lato vetrato bloccato, senza serratura - also available with fixed glass side, without lock - Également disponible avec côté vitré bloqué, sans serrure

MIAMI

L'elegante essenzialità
dei grandi classici

The essential **elegance**
of the great classics

Les traits essentiels
des grands classiques
tout en **élégance**

MIAMI

L'elegante essenzialità dei grandi classici

Un concentrato di alta tecnologia, studi illuminotecnici e nuove strategie espositive per dare grande risalto emozionale e massima visibilità alle bottiglie di vino anche in spazi ridotti.

I led posizionati lungo la cornice della porta e gli interni laminati concorrono a creare un particolare effetto profondità e dei suggestivi giochi di luce che esaltano l'impatto visivo offrendo nuovi sguardi sulla qualità dei contenuti di un vero e proprio scrigno di sapori.

The essential elegance of the great classics

A concentration of high technology, advanced lighting and the latest display strategies add visibility and emotion to any wine selection, even in small spaces.

LED lights around door frames and laminate interiors combine to create a unique sensation of depth. Enchanting light effects increase visual impact and emphasise the quality of the wines stored in this unique 'flavour chest'.

Les traits essentiels des grands classiques tout en élégance

Un concentré de haute technologie, des études sur les techniques d'éclairage et de nouvelles stratégies d'exposition pour créer l'émotion et offrir une visibilité maximale aux bouteilles de vin, même dans les espaces réduits.

Les LEDs positionnées le long de l'encadrement de la porte et les intérieurs stratifiés se marient parfaitement pour créer un effet de profondeur particulier et des jeux de lumière suggestifs qui renforcent l'impact visuel en offrant un nouveau regard sur la qualité du contenu d'un véritable écrin de saveurs.



4 SIZES



WIDE
INTERIORS



INTEGRATED
REFIGERATION



MIAMI

Scegli tra 4 misure, affiancabili a piacere
 Choose from 4 sizes, all installable side by side
 Choisissez parmi 4 tailles, juxtaposables à souhait



4 SIZES

Wine



MIAMI B&R



MIAMI



MIAMI MEDIUM



MIAMI MINI



Affiancabili a piacere
 Le cantinette Miami possono essere affiancate facilmente, creando in questo modo ampi spazi espositivi continui.

Side-by-side installation as needed
 Miami cabinets can easily be installed side by side to create large, continuous displays.

Juxtaposables à souhait
 Les caves à vin Miami sont facilement juxtaposables, créant ainsi de grands espaces d'exposition continus.

Massima visibilità

La priorità viene data all'illuminazione per enfatizzare al massimo le bottiglie di vino contenute al suo interno. I led (2700°K) inseriti frontalmente lungo la cornice della porta e gli interni laminati creano un effetto di profondità e dei giochi di luce che mettono in primo piano le bottiglie di vino.

Improved lighting

With improved lighting, the Miami unit offers the ultimate wine bottle display. LED lights (2700°K) are embedded all along the front door frame and the internal finishing create depth and pleasant lighting effects, while enhancing the visibility of wine bottles.

Priorité à éclairage

La priorità accordée à l'éclairage permet de mettre en lumière les bouteilles de vin contenues à l'intérieur. Les LED (2700°K) frontales sur le pourtour de la porte et les intérieurs stratifiés créent un effet de profondeur ainsi que des jeux de lumière qui participent à la mise en scène les bouteilles de vin.



Rivestimento

La struttura del mobile è rivestita in laminati "metal" (873) o "soft touch" (720, 718). I telai delle porte sono in alluminio anodizzato grigio o nero. Opzionale: è possibile scegliere altri colori per il rivestimento in laminato, ma il telaio della porta rimane anodizzato grigio o nero.

Linings

Cabinet structure covered in "metal" (873) or "soft touch" (720, 718) laminates. Door frames are in grey or black anodised aluminium. Opzionale: other laminate covering colours can be specified, but door frames are available only in anodised grey or black.

Revêtements

La structure du meuble est habillée de stratifiés "métal" (873) ou "soft touch" (720, 718). Les châssis de portes sont en aluminium anodisé gris ou noir. Option: choix possible d'autres coloris pour le revêtement en stratifié, mais le châssis de la porte reste anodisé gris ou noir.

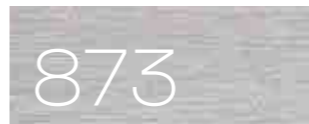

Grigio Alluminio Satinato
 Brushed Aluminium Grey
 Gris aluminium satiné



Nero opaco "Soft Touch"
 "Soft Touch" Matte Black
 "Soft Touch" Noir



Grigio Opaco "Soft Touch"
 "Soft Touch" Matte Grey
 "Soft Touch" Gris

MIAMI

Interni più ampi e 4 allestimenti a scelta
More spacious interiors and a choice of 4 equipment types
Des intérieurs plus larges et 4 agencements différents au choix



Più spazio e meno ingombro

Grazie all'innovativo sistema di refrigerazione (privo di piastra evaporante) gli interni sono più ampi. Viene aumentata la capienza di bottiglie e l'interno laminato crea un effetto di visibilità a 360°. Tutto questo in soli 50 cm di profondità.

Layout a scelta

Possibilità di disporre le bottiglie in verticale, in obliquo o in orizzontale, a seconda delle preferenze. Su ripiani inox forati (R), su tubi in acciaio (T) o su eleganti cassetti estraibili in legno (DR).

More space inside, more compact outside

More space inside thanks to an innovative refrigeration system (with no evaporator plate). Bottle capacity is increased and the laminate interior creates an all-round visibility effect. All in just 50 cm of depth.

Choice of layouts

Bottles can be displayed vertically (stainless steel shelves: R), on an incline (stainless steel tubes: T) or horizontally (pull-out wood drawers: DR), according to individual preferences.

Plus d'espace et moins d'encombrement

Grâce au système de réfrigération innovant (sans plaque d'évaporation), les intérieurs sont plus spacieux. La capacité en nombre de bouteilles est augmentée et l'intérieur stratifié crée un effet panoramique à 360°. Tout cela avec seulement 50 cm de profondeur.

Agencement personnalisable

Possibilité de disposer les bouteilles en verticale, inclinées ou en horizontale, selon vos préférences. Sur des étagères en inox perforées (R), à tubes en acier (T) ou sur d'élégants tiroirs coulissants en bois (DR).



MIAMI

Una tecnologia che aumenta silenziosità e risparmio energetico
 Technology for more silent operation and improved energy saving
 Une technologie pour un fonctionnement encore plus silencieux
 et une plus grande économie d'énergie



Refrigerazione MONO-ZONA

La versione con refrigerazione ventilata permette di scegliere il set preferito di temperatura uniforme interna. Impostazioni da 4°C a 18°C.

SINGLE-ZONE refrigeration

The fan assisted refrigeration optional version, allows to choose the favourite internal uniform temperature set. The temperature can be set anywhere from 4°C to 18°C.

Réfrigération MONO-ZONE

La version à froid ventilé permet de choisir une configuration de température intérieure uniforme préférentielle. Réglages de 4°C à 18°C.



Rumorosità ridotta al minimo

Il sistema di refrigerazione con condensazione statica è concepito per ridurre al minimo la rumorosità dell'impianto refrigerante.

Noise reduction

The static condensation system is designed to provide maximum noise reduction of the refrigeration equipment.

Réduire le bruit

Le système de froid à condensation statique est conçu pour réduire le bruit du système réfrigérant au minimum.



ECO FRIENDLY

Risparmio energetico

Riduzione dei consumi rispetto alle tradizionali cantinette per vino grazie alla illuminazione a led, vetro basso emissivo ed un isolamento di 6 cm.

Energy efficiency

Less energy consumption in comparison to traditional wine cabinets due to the LED lighting, 60mm thick insulation and the low emission double glazing glass door.

Économie d'énergie

Réduction de consommation par rapport aux vinothèques traditionnelles, grâce à l'éclairage à LED, au verre à faible émissivité et à une isolation de 6 cm.



Vetro interno a bassa emissività
 Low emission internal glass
 Verre à faible émissivité



Refrigerazione MULTI-ZONA

È facile ottenere la versione con refrigerazione statica, basta premere il pulsante specifico per passare da monotemperatura a multitemperatura. In questo modo nella stessa unità si ottengono quattro temperature diverse da 4°C a 18°C e quindi si possono esporre correttamente tanto i vini rossi che quello bianchi.

MULTI-ZONE refrigeration

It's easy to switch to static refrigeration. Just press the mode button to change from single to multi-temperature functioning. In multi-zone mode you can set four different temperatures from 4°C to 18°C and display both red and white wines under exactly the right conditions.

Réfrigération MULTI-ZONE

Pour passer en mode réfrigération statique, c'est très simple, il suffit d'appuyer sur le bouton spécifique pour passer de la mono-température à la multi-température. La même unité offre ainsi quatre températures différentes allant de 4°C à 18°C de sorte que vins rouges et vins blancs bénéficient d'une exposition optimale.



Il pulsante per passare da monotemperatura a multitemperatura e viceversa.

*versione non presente nel modello MIAMI MINI

The button for toggling between single-zone and multi-zone refrigeration.

*not present on MIAMI MINI model

Le bouton pour passer de la mono-température à la multi-température et vice-versa.

*Version non disponible pour le modèle MIAMI MINI

Controllo da remoto (IoT)

Il controllo della macchina può avvenire da remoto utilizzando il modulo Wi-Fi opzionale e la piattaforma cloud.

Remote control (IoT)

Wine cellar can be controlled remotely using an optional Wi-Fi module and the cloud platform.

Contrôle déporté (IdO)

Le contrôle de la cave à vin se fait à distance grâce au module Wi-Fi en option et à la plateforme cloud.

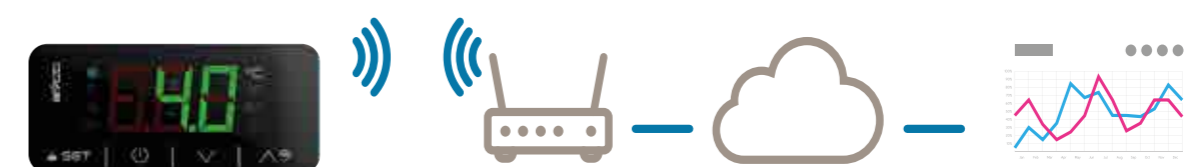

MIAMI

T.A. 30°C - U.R. 55%
CLIMATE CLASS 4



MIAMI B&R

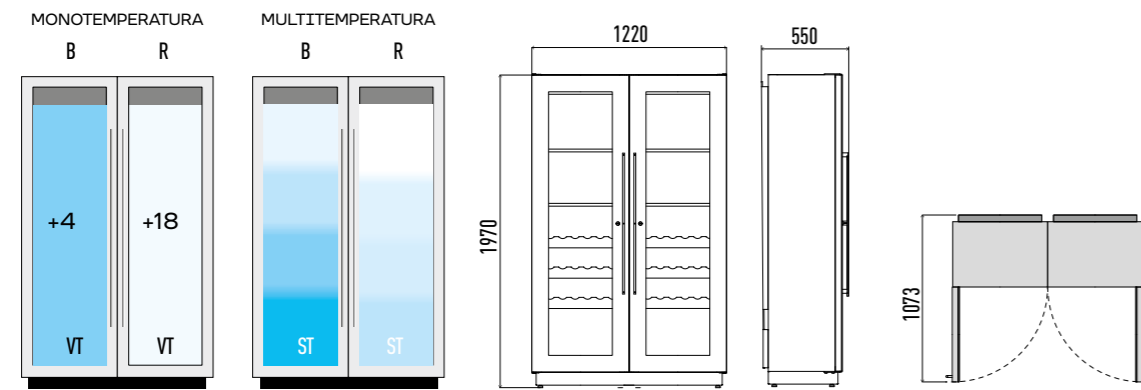

MIAMI B&R

		Euro	
MIAMI B&R VT RFT	AIMIAMIBRVTP/²	12.650	84+84
MIAMI B&R VT RF 12 + 12 DR	AIMIAMIBRDVRT/²	14.900	72+72
MIAMI B&R VT RFT + 3 DR	AIMIAMIBRMIXVTP/²	13.610	66+66
MIAMI B&R VT RFR	AIMIAMIBRSHVTP/²	12.905	108+108

OPTIONAL

OPT36001 (singolo vano - each compartment) - Versione predisposta per remotizzazione (senza unità) - Prearranged remotable version (without condensing unit) **-250**

OPT36003 (singolo vano - each compartment) - Luci LED tonalità fredda (5500-6500° K) - Cool white LED lighting (5500-6500° K) **85**

OPT36004 (singolo vano - each compartment) - Dimmer **135**

OPT36005 Valvola altimetrica vetrocamera (>900 slm) Double glazing pressure equalisation valve (>900 m.as) **380**

MIAMI

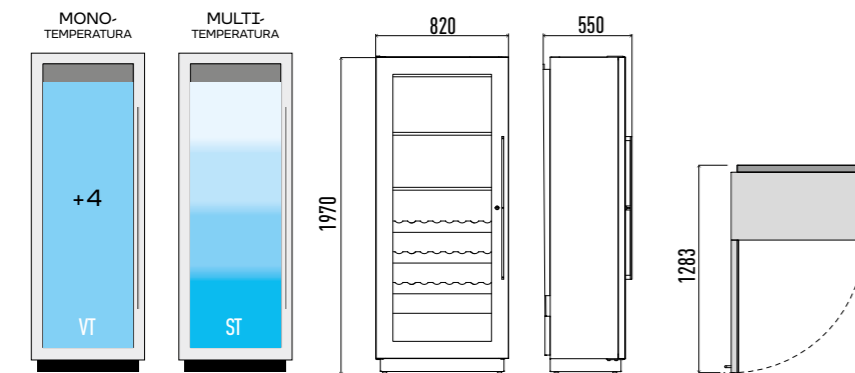

MIAMI

		Euro	
MIAMI VT RFT	AIMIAMIVTP/²	6.970	126
MIAMI VT RF 12 DR	AIMIAMIDRVTP/²	8.205	96
MIAMI VT RFT + 3 DR	AIMIAMIMIXVTP/²	7.410	96
MIAMI VT RFR	AIMIAMISHVTP/²	7.075	162

MIAMI MEDIUM

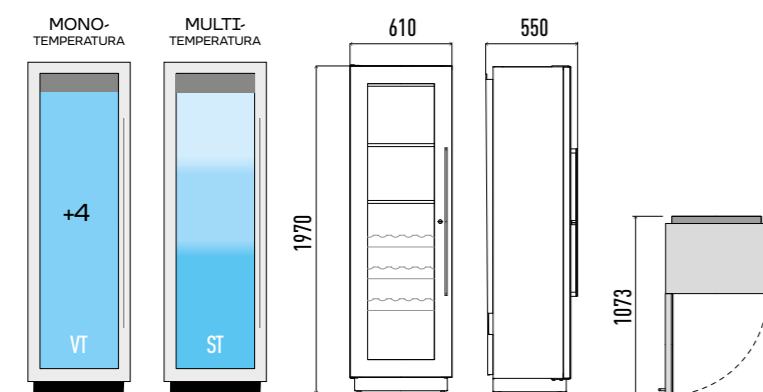

MIAMI MEDIUM

		Euro	
MIAMI MEDIUM VT RFT	AIMIAMIMEDVTP/²	6.530	84
MIAMI MEDIUM VT RF 12 DR	AIMIAMIMEDDRVTP/²	7.590	72
MIAMI MEDIUM VT RFT + 3 DR	AIMIAMIMEDMIXVTP/²	6.770	66
MIAMI MEDIUM VT RFR	AIMIAMIMEDSHVTP/²	6.570	108

MIAMI MINI

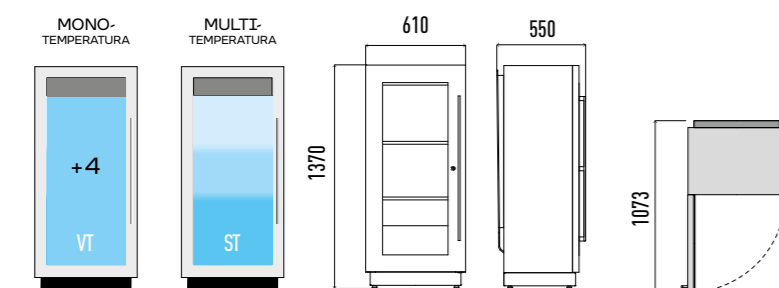

MIAMI MINI

		Euro	
MIAMI MINI VT RFT	AIMIAMIMINIVTP/²	5.340	48
MIAMI MINI VT RF 6 DR	AIMIAMIMINIDRVTP/²	5.810	36
MIAMI MINI VT RFR	AIMIAMIMINISHVTP/²	5.480	60

WINEMAX



WINEMAX

Scegli il potere di attirare l'attenzione

Scenografica. Essenziale. Poderosa. Se quello che desideri è impressionare i tuoi clienti e creare un angolo spettacolare all'interno del tuo locale, WINEMAX è quello che fa per te. Con la sua straordinaria altezza (260 cm) e una larghezza di soli 67 cm, questa vetrina frigorifera svetta elegante nell'ambiente e attira gli sguardi sulle tue bottiglie migliori. Alza gli occhi. E prenditi l'attenzione che ti spetta.

Choose the ability to attract attention

Stylish. Essential. Impressive. If you really want to impress your customers and create a spectacular display area in your dining room, WINEMAX is the cabinet for you. With its exceptional height (260 cm) and a width of only 67 cm, this refrigerated display cabinet brings a touch of elegance to your premises and draws your customers' attention to your best wines. Look up. Grab the attention you deserve.

Donnez-vous le pouvoir d'attirer l'attention

Scénographique. Essentielle. Puissante. Si vous souhaitez impressionner vos clients et créer un aménagement scénographique dans votre établissement, WINEMAX est faite pour vous. Du haut de ses impressionnants 260 cm pour une largeur de seulement 67 cm, cette vitrine réfrigérée à la forme élancée se dresse avec élégance dans son environnement et attire les regards sur vos meilleures bouteilles. Levez les yeux. Et retenez toute l'attention que vous méritez.



ATTRACTIVE POINT



PRACTICAL SPACE



CUSTOM INTERNAL LAYOUT



ATTRACTIVE POINT

Wine

WINEMAX

Disegnata per conquistare

260 cm di altezza per 67 cm di larghezza e 66 cm di profondità: WINEMAX si eleva con grazia sulle pareti dei locali, esile e slanciata.

I materiali sono i migliori: vetro, alluminio, acciaio, laminati sofisticati. Insieme a loro, i giochi di riflessi degli interni a specchio, le atmosfere attraenti create dall'illuminazione a led calda e uniforme e i due rivestimenti esterni nero opaco e grigio opaco nell'innovativa finitura soft touch, piacevole al tatto e finemente contemporanea, creano una seduzione visiva intensa che si diffonderà a tutto l'ambiente.

Designed to impress

260 cm in height by 67 cm in width and 66 cm in depth: the slender WINEMAX stands graceful and tall against your walls. Materials are naturally the best: glass, aluminium, steel, and sophisticated laminates. Added to these, the reflections produced by a mirror-finish interior, the enticing atmospheres generated by uniform, warm LED lighting and the two outer covering materials in matte black and matte grey, with their stylishly contemporary look and pleasing soft-touch feel, create an intensely seductive look that radiates the entire room.

Conçue pour conquérir

260 cm de hauteur pour 67 cm de largeur et 66 cm de profondeur: WINEMAX s'élève gracieusement le long des parois des établissements, fine et élancée. Elle est revêtue des meilleurs matériaux: verre, aluminium, acier et stratifiés raffinés. À cela s'ajoutent le jeu de reflets des intérieurs en miroir, l'atmosphère séduisante de l'éclairage à LED chaud et uniforme et les deux revêtements extérieurs noir mat et gris mat dans l'innovante finition « soft touch », à la fois agréable au toucher et finement contemporaine. Autant d'atouts qui exercent une irrésistible séduction visuelle qui opère dans toute la pièce.



Interni a specchio

La finitura specchiata dei materiali interni disegna nuovi e pregevoli percorsi di luce intorno alle bottiglie.

Mirror-finish interiors

The mirror finish of the interior lining materials produces original lighting effects between and around the bottles.

Intérieurs en miroir

La finition miroir des matériaux intérieurs crée de nouveaux jeux de lumière remarquables autour des bouteilles.



PRACTICAL
SPACE

Wine

WINEMAX

All'altezza di ogni immaginazione

Una sola colonna, per un punto vini distinto. Una composizione di due o tre vetrine affiancate, per una capienza maggiore. O, ancora, un'intera parete funzionale e attrezzata a tutt'altezza. Grazie alla sua struttura modulare, WINEMAX ti permette di dare concretezza alle tue immaginazioni più ardite.

The height of imagination

A single, tall column for a truly distinctive wine display. A two or three door configuration for greater capacity. Or even a complete wall, functionally equipped to its full height. Thanks to its modular structure, WINEMAX lets you realise any configuration you can imagine.

À la hauteur de toutes les imaginations

Une seule colonne, pour un espace vins de grande classe. Une composition de deux ou trois vitrines côte à côte, pour une plus grande capacité. Ou encore, une paroi entière fonctionnelle et équipée toute hauteur. Grâce à sa structure modulaire, WINEMAX vous permet de donner vie à vos imaginations les plus audacieuses.

Apertura a destra o sinistra

A seconda di come ti piace di più, la maniglia è disposta sul lato destro o sinistro della vetrina.

Right or left hand opening

Handles can be fitted to the right or left side of the door to meet your needs and preferences.

Ouverture à droite ou à gauche

Selon votre préférence, la poignée est placée sur le côté droit ou gauche de la vitrine.

2600

670



PRACTICAL
SPACE

Wine

WINEMAX

Crea lo spettacolo che preferisci
Put on your favourite show
Créez votre spectacle préféré

Finiture contemporanee e strategiche

Il materiale di ultima generazione scelto per il rivestimento esterno si caratterizza per il suo aspetto raffinato e opaco e la bassa riflessione della luce. Meravigliosamente vellutato al tatto, è anti-impronta e si rigenera in seguito ai micro-graffi superficiali.

Contemporary, strategic finishes

The latest-generation material chosen for the outer covering stands out for its refined, matte finish and low reflectance. This material has an amazing velvety feel, is finger-mark resistant and even recovers from micro-scratches.

Finitions contemporaines et stratégiques

Le matériau de dernière génération choisi pour le revêtement extérieur se caractérise par son aspect mat et raffiné et sa faible réflexion de la lumière. Merveilleusement velouté au toucher, il est anti-empreintes et se régénère après les micro rayures de surface.

720	Nero opaco "Soft Touch" "Soft Touch" Matte Black "Soft Touch" Noir mat
718	Grigio Opaco "Soft Touch" "Soft Touch" Matte Grey "Soft Touch" Gris mat
873	Gebürstetes Aluminium-Grau Gris Aluminium Satinado Серый алюминиевый сатиновый

Illuminazione a led calda e uniforme

Led 2700K, bianco caldo, con copertura opale per una diffusione luminosa omogenea.

Uniform, warm LED lighting

2700K warm white LED lamps with opal white covers generate uniform diffused light.

Éclairage à LED chaud et uniforme

LED 2700 K, blanc chaud, avec couverture opale pour une diffusion homogène de la lumière.



CUSTOM
INTERNAL
LAYOUT

Wine

E all'interno?





Puoi mostrare i tuoi vini in verticale, su ripiani in acciaio inox (R), oppure utilizzare i tubi in acciaio, orizzontali o inclinati (T, A). Altre opzioni? I cassetti estraibili completi di culle (GK94210001) o le raffinate culle in plexiglass (C). WINEMAX ti dà lo spazio e la scena. Tu scegli come muovere i protagonisti.

And inside?

You can display your bottles vertically, on stainless-steel shelves (R), or using steel tubes, arranged horizontally or on a slope (T, A). Other options? Pull-out drawers with internal cradles (GK94210001) or refined plexiglass cradles (C). WINEMAX sets the stage you need. Leaving you free to play the leading role.

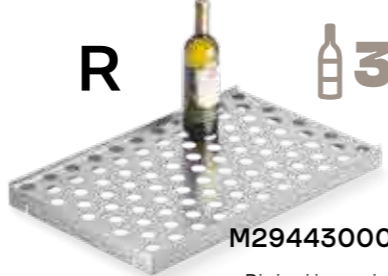
Et à l'intérieur ?

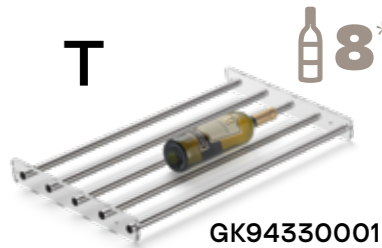
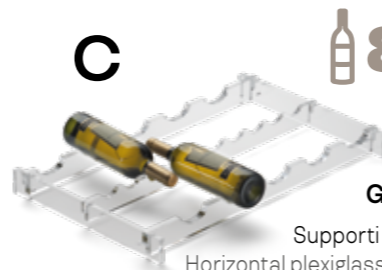
Vous pouvez exposer vos vins à la verticale, sur des étagères en acier inoxydable (R), ou utiliser des tubes en acier, à l'horizontale ou inclinés (T, A). D'autres options ? Les tiroirs coulissants avec clayettes (GK94210001) ou les élégantes clayettes en plexiglas (C). WINEMAX vous donne l'espace et la scène. À vous de diriger les protagonistes.

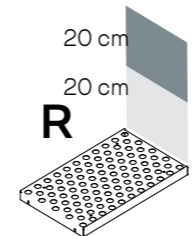
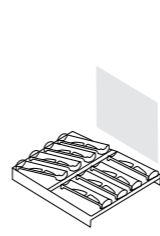
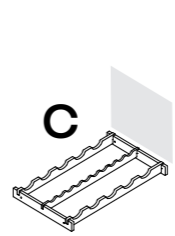
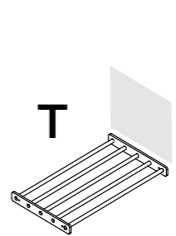
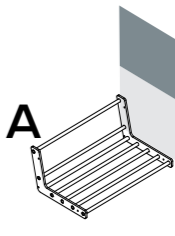
<p>R  36*</p> <p>M294430001 Ripiani in acciaio Steel Shelves Étagères en acier</p>	<p>A  24*</p> <p>GK94330002 Tubi in acciaio inclinati Sloping Steel Tubes Tubes en acier inclinés</p>	<p>T  8*</p> <p>GK94330001 Tubi in acciaio Steel Tubes Tubes en acier</p>		
<p>C  8*</p> <p>GK94080001 Supporti orizz. in Plexiglass Horizontal plexiglass bottle supports Berceaux horiz. en plexiglas</p>	<p>GK94210001  8*</p> <p>Cassetto estraibile completo di culle Pull-out drawer with bottle supports Tiroir coulissant avec clayettes</p>			
<p>R </p> <p>M294430001</p>	<p>GK94210001 </p> <p>GK94210001</p>	<p>C </p> <p>GK94080001</p>	<p>T </p> <p>GK94330001</p>	<p>A </p> <p>GK94330002</p>

WINEMAX

Le tecnologie al servizio dell'esibizione
Technology at the service of presentation
Les technologies au service de l'exposition



Refrigerazione ventilata

Per l'ambiente interno della vetrina puoi selezionare una temperatura* dai 4° ai 18°.

*per la classe climatica 4.

Ventilated refrigeration

You can set any temperature* between 4° and 18° inside the cabinet.

* for climate class 4.

Réfrigération ventilée

Pour l'intérieur de la vitrine, vous pouvez sélectionner une température* de 4 °C à 18 °C.

* pour la classe climatique 4.



Vetro interno a bassa emissività

Il vetro interno altamente isolante permette il passaggio della luce ma contiene con massima efficacia le dispersioni termiche.

Low emissivity internal glass

High insulation interior glass allows the unrestricted passage of light but effectively prevents heat transfer.

Verre interne à faible émissivité

Le verre interne à haute isolation laisse passer la lumière mais limite efficacement les dispersions thermiques.



(optional)

Controllo umidità relativa

Su richiesta, questo sistema assicura un livello di umidità relativa sempre maggiore del 50%, permettendo così di conservare perfettamente tappi ed etichette.

Relative humidity control

On request, this system keeps relative humidity above 50% to ensure that corks and labels are perfectly preserved.

Contrôle de l'humidité relative

Sur demande, ce système assure un niveau d'humidité relative toujours supérieur à 50 %, permettant donc de conserver parfaitement les bouchons et les étiquettes.



Controllo da remoto (OPTIONAL)

Vuoi regolare nel massimo agio tutte le impostazioni di WINEMAX, senza dover raggiungere manualmente il controller disposto in cima alla vetrina? Scegli il controllo da remoto. Questa tecnologia, attraverso un modulo wi-fi e una piattaforma cloud, permette un'interfaccia semplice con il tuo smartphone o con il dispositivo che preferisci. Così puoi accendere o spegnere la vetrina, impostare la temperatura, regolare l'intensità delle luci e gli altri parametri senza muoverti dalla tua sedia più comoda.

OPTIONAL Remote control

Wouldn't you love to adjust all WINEMAX settings without having to touch the controller at the top of the display? Just choose remote control. Remote control technology uses a wi-fi module and a cloud platform to provide a user-friendly interface for your smartphone or preferred device. The remote control option lets you switch the display on and off, set temperature, and adjust lighting intensity and other parameters without getting up from your favourite armchair.

Contrôle déporté EN OPTION

Vous voulez régler tous les paramètres de WINEMAX à votre aise, sans avoir à atteindre manuellement le contrôleur situé en haut de la vitrine ? Optez pour le contrôle déporté. Grâce à un module Wi-Fi et une plateforme cloud, cette technologie vous offre une interface simple avec votre smartphone ou avec l'appareil de votre choix. Vous pouvez ainsi allumer ou éteindre la vitrine, régler la température, l'intensité de l'éclairage et d'autres paramètres sans bouger de votre fauteuil, confortablement installé.

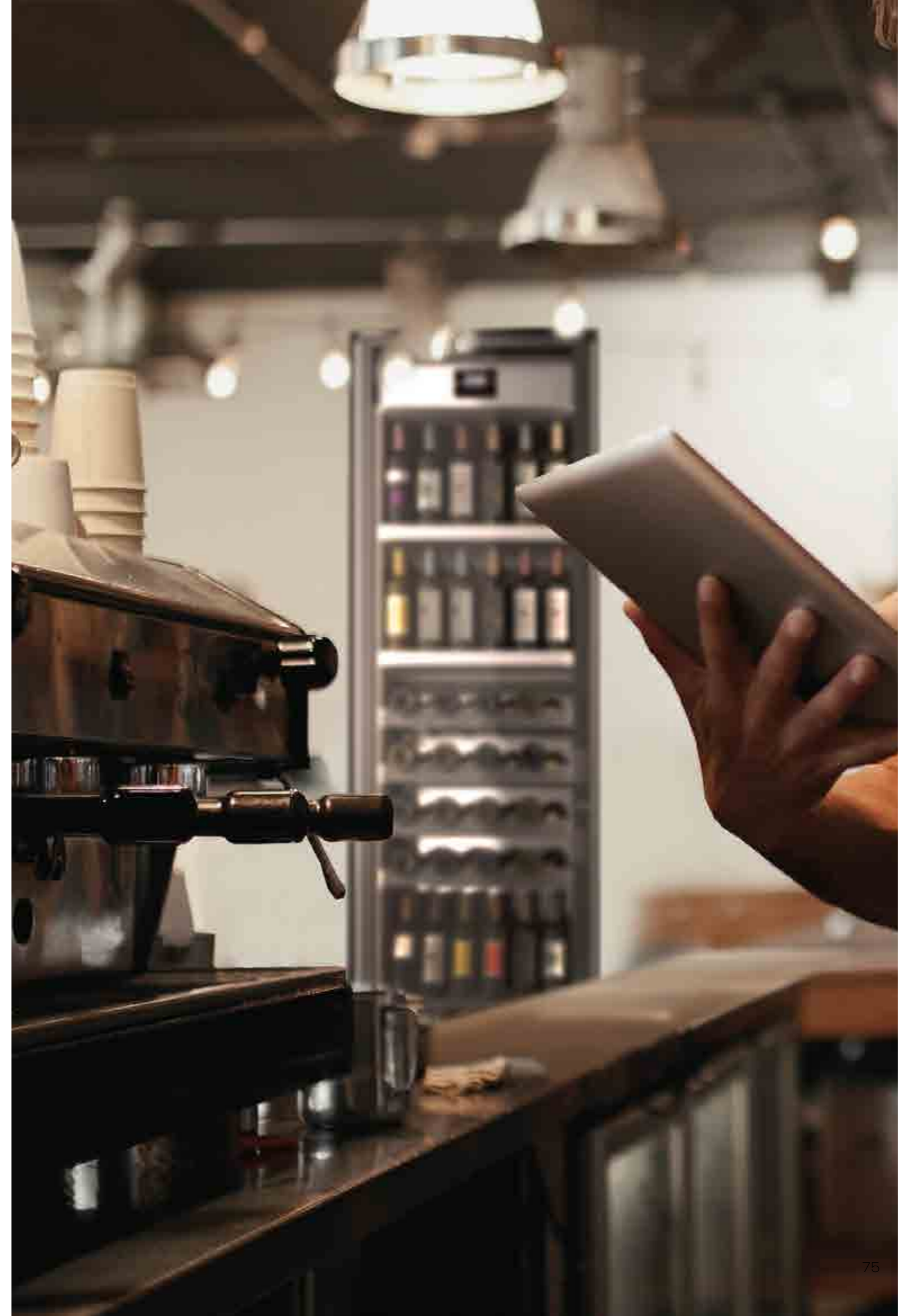

Motore remoto o vano tecnico, a voi la scelta

I moduli singoli sono predisposti per l'impianto remoto (al fine di evitare calore e rumore nell'ambiente in cui verranno inserite), oppure hanno un vano tecnico con il motore a bordo.

Remote or on-board motor. You choose.

Individual modules come with provision for a remote system (to avoid heat and noise in the room where they are installed), or have a technical compartment with an on-board motor.

Moteur déporté ou compartiment technique, selon votre choix

Chacun des modules est préconfiguré pour le système de moteur déporté (afin d'éviter la chaleur et le bruit à l'endroit où ils seront insérés), ou est doté d'un compartiment technique avec moteur embarqué.



MOTORE A BORDO
ON-BOARD MOTOR
MOTEUR EMBARQUÉ

18
n° max bott. nicchia motore
pcs max. no. bottles motor
compartment
p.ces Nbre max. bout. niche
moteur

Capacità massime modulo colonna singola (bottiglie bordolesi)
Maximum capacities, single column module (Borderlaise bottles)
Capacité maximale module à colonne unique (bouteilles bordelaises)

		VERSIONI REMOTE REMOTE VERSIONS VERSIONS DÉPORTÉES		VERSIONI CON MOTORE A BORDO ON-BOARD MOTOR VERSIONS VERSIONS AVEC MOTEUR EMBARQUÉ	
		MAX	MAX	MAX	MAX
R	Ripiani in acciaio - Stainless Steel Shelves - Étagères en acier	7 x 36	252	6 x 36 + 18	234
A	Tubi in acciaio inclinati - S. Steel Sloping Tubes Tubes en acier inclinés	7 x 24	168	6 x 24 + 18	162
T	Tubi in acciaio - SteelTubes - Tubes en acier	14 x 8	112	12 x 8 + 18	114
C	Supporti orizz. in Plexiglass - Plexiglass Horiz. Supports - Berceaux horiz. en plexiglas	14 x 8	112	12 x 8 + 18	114
GK94210001	Cassetto estraibile completo di culle - Pull-out drawer with bottle supports - Tiroir coulissant avec clayettes	14 x 8	112	12 x 8 + 18	114

				MAX	Code	Euro
WINEMAX	REMOTO - REMOTE - DÉPORTÉ	U.R.%	s/vaschetta scioglicondensa - wo/condensate drip tray - s/bac à condensats av/moteur débranché	252	HRUD1	11.170
WINEMAX	REMOTO - REMOTE - DÉPORTÉ	VT	s/vaschetta scioglicondensa - wo/condensate drip tray - s/bac à condensats av/moteur débranché	252	HRVD1	10.895
WINEMAX	REMOTO - REMOTE - DÉPORTÉ	U.R.%	s/vaschetta scioglicondensa c/motore scollegato - wo/condensate drip tray w/disconnected motor - s/bac à condensats av/moteur débranché	252	HFUD1	11.480
WINEMAX	REMOTO - REMOTE - DÉPORTÉ	VT	s/vaschetta scioglicondensa c/motore scollegato - wo/condensate drip tray w/disconnected motor - s/bac à condensats av/moteur débranché	252	HFVD1	11.205
WINEMAX	MOTORE A BORDO - N-BOARD MOTOR - MOTEUR EMBARQUÉ	U.R.%		234	HMUD1	11.320
WINEMAX	MOTORE A BORDO - ON-BOARD MOTOR - MOTEUR EMBARQUÉ	VT		234	HMVD1	11.055

INTERNAL LAYOUT / OPTIONALS

	Code	Euro
Tubi in acciaio - SteelTubes - Tubes en acier "T"	GK94330001	180
Tubi in acciaio inclinati - S. Steel Sloping Tubes Tubes en acier inclinés "A"	GK94330002	225
Ripiani in acciaio - Stainless Steel Shelves - Étagères en acier "R"	M294430001	150
Supporti orizz. in Plexiglass - Plexiglass Horiz. Supports - Berceaux horiz. en plexiglas "C"	GK94080001	225
Cassetto estraibile completo di culle - Pull-out drawer with bottle supports - Tiroir coulissant avec clayettes	GK94210001	355
Vaschetta scioglicondensa - Condensate drip tray	OPT87011	350
DIMMER	EL00590158	320
Valvola altimetrica vetrocamera - Double glazing pressure equalisation valve - VANNE ALTIMÉTRIQUE DOUBLE VITRAGE (>900 sim)	OPT36005	380
OPZIONE COLORE LAMINATO SPECIALE - SPECIAL LAMINATED OPTIONAL COLOURS - OPTION COLORIS STRATIFIÉ SPÉCIAL	OPT87004	910

Codice - Code - Code

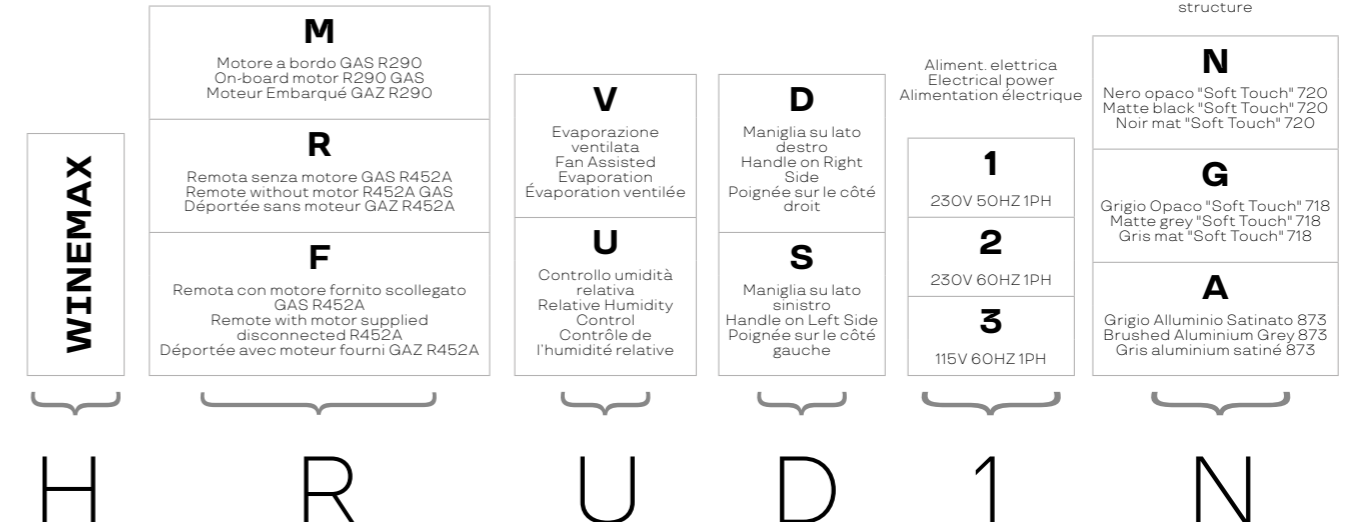

i.Am[®]

Capolavoro di versatilità
e innovazione

A masterpiece of versatility
and innovation

Chef-d'œuvre
de polyvalence
et d'innovation



Le performance dell'ecosostenibilità

Classe A, completamente made in Italy, i.Am è la cantinetta frigorifera per locali contemporanei e ambiziosi, che vogliono attirare i clienti e giocare al meglio con lo spazio nel pieno risparmio energetico.

Performance and sustainability

With Class A energy efficiency and 100% Italian production, i.Am is the refrigerated wine display for ambitious, contemporary catering businesses who want to attract customers, make full use of available space and save energy too.

Les performances de l'éco-durabilité

De classe A, entièrement fabriquée en Italie, i.Am est la cave à vin réfrigérée des établissements contemporains et ambitieux qui souhaitent attirer les clients et jouer avec l'espace de la meilleure façon possible en faisant des économies d'énergie.



HIGH CAPACITY



CUSTOM INTERNAL LAYOUT



ENERGY SAVING



RECYCLED RECYCLABLE



Up to **260*** 

Hai in mente qualcosa di speciale?

Che tu abbia necessità di una grande capienza o di una massima valorizzazione estetica delle bottiglie, che tu voglia ottimizzare gli spazi utilizzando anche gli angoli più intimi del locale, la varietà di i.Am permette di trovare in ogni caso la soluzione migliore.

Something special in mind?

Whether you are on the lookout for high capacity or striking presentation, or want to exploit the tightest corners of your premises, i.Am offers the variety you need to find the perfect solution.

Vous avez quelque chose de particulier en tête ?

Que vous ayez besoin d'une grande capacité ou de mettre vos bouteilles en valeur d'un point de vue esthétique, ou que vous souhaitiez optimiser l'espace en utilisant les moindres recoins de la pièce, grâce à la grande variété de i.Am vous trouverez toujours la solution optimale.

75
cm



130* MAX

H1600 (SHELVES)



195* MAX

H2000 (SHELVES)



75
cm

260* MAX

Wine

Colori

La struttura del mobile è di colore nero.
La cornice della porta è in legno con finitura Silver (A), Black (N) o Light Wood (C).
Nel caso di cassetti interni i frontalini in legno sono coordinati con la cornice esterna.

Colour options

The cabinet's structure is black in colour.
The door surround is in wood with a Silver (A), Black (N) or Light Wood (C) finish.
If drawers are fitted internally, their wood fronts match the outside surround.

Coloris

La structure du meuble est noire.
Le cadre de la porte est en bois avec une finition Argent (A), Noir (N) ou Bois clair (C).
Si des tiroirs intérieurs sont présents, les panneaux frontaux en bois sont coordonnés au cadre extérieur.

Silver



Black



Light wood



TROPICALIZED
VERSION
POSSIBLE



* Capacità con bottiglie bordolesi - Capacity with Bordolaise bottles - Capacité avec des bouteilles bordelaises



Profondità ridotta, libertà ancora più grande

Con soli 55 cm di profondità, i.Am Fit è la versione più sottile presente sul mercato. Può adattarsi agli ambienti e alle metrature più particolari. Facilita le operazioni di interior design e la progettazione, così come l'organizzazione del locale, permettendoti di conquistare lo sguardo dei clienti in ogni situazione.

Less depth, greater freedom

With a depth of only 55 cm, i.Am Fit is the slenderest of all wine display cabinets. Thanks to this, it fits in perfectly even in the smallest and most awkward spaces. i.Am Fit facilitates interior design and planning, makes the arrangement of furnishings easy, and helps you capture your customers' attention in all situations.

Une profondeur réduite et encore plus de liberté

Avec seulement 55 cm de profondeur, i.Am Fit est la version la plus fine du marché. Elle s'adapte aux environnements et aux surfaces les plus exigeants. Elle offre des solutions pratiques pour le design d'intérieur et les projets d'aménagement, mais aussi en termes d'agencement de l'établissement, et vous permettra de capter le regard des clients en toute situation.

55
cm

FIT H2000
(SHELVES)



82
cm

144* MAX

FIT 55
cm



i.Am® FIT SLIM

NEW



55 cm di profondità,
60 cm di larghezza

i.Am FIT può diventare ancora più sottile, agile e versatile nella versione SLIM, con una larghezza di soli 60 cm.

55 cm deep,
60 cm wide

i.Am FIT gets even more slender, agile and versatile in the SLIM version, which is only 60 cm wide.

55 cm de profondeur,
60 cm de largeur

i.Am FIT peut être encore plus fine, plus flexible et plus polyvalente dans la version SLIM, avec une largeur de seulement 60 cm.



FIT SLIM H1600
(SHELVES)



55
cm

60
cm

72* MAX

Tutte le possibilità di SLIM

i.Am FIT SLIM è presente in due opzioni di altezza e nella speciale variante doppia (B&R), per una massima libertà di scelta e un'ottima valorizzazione anche degli angoli meno spaziosi.

FIT SLIM H2000
(SHELVES)



60
cm

96* MAX

Anything is possible with SLIM

i.Am FIT SLIM comes in two height variants and in a special double (B&R) version, offering great freedom of choice and allowing even the tightest spaces to be exploited.

FIT SLIM DOPPIA H2000
(SHELVES)



55
cm

60+60
cm

192* MAX

Toutes les variantes de SLIM

i.Am FIT SLIM est disponible en deux hauteurs et dans la variante spéciale double (B&R), pour une liberté de choix maximale et pour optimiser et mettre en valeur les moindres recoins.

i.Am DUAL VENT

Due temperature diverse nella stessa cantina vino

Tanti vini e poco spazio? Con i.Am Dual Vent puoi tenere vini bianchi e rossi nella stessa cantinetta e impostare due temperature diverse. Grazie ai due vani di carico refrigerati e ventilati separatamente, puoi decidere il clima interno a ciascuno spazio e assicurare la temperatura perfetta a tutte le tue bottiglie.

Two separate temperature zones in the same wine display

Too many bottles for the space? With i.Am Dual Vent, you can keep whites and reds in the same display and set two different storage temperatures. Thanks to two separately ventilated and refrigerated compartments, you can set storage conditions independently for each compartment and guarantee exactly the right temperature for all your wines.

Deux températures différentes dans la même cave à vin

Beaucoup de vins et peu d'espace? Avec i.Am Dual Vent, vous pouvez conserver des vins blancs et rouges dans la même cave à vin en réglant deux températures différentes. Grâce aux deux compartiments de stockage avec réfrigération et ventilation indépendantes, vous pouvez décider de la température intérieure de chaque espace pour qu'il soit parfaitement adapté à vos bouteilles.



T.A. 30°C - U.R. 55%
CLIMATE CLASS 4



Profondità diverse per capienze diverse
Different depths for different capacities
Différentes profondeurs pour différentes capacités

Facile da configurare
Easy to configure
Facile à configurer

Due vani di carico refrigerati e ventilati separatamente.
Two separate storage zones refrigerated and ventilated.
Deux compartiments de stockage avec réfrigération et ventilation indépendante.

I Scegli una zona
Select a zone
Choisissez une zone

II Imposta la Temperatura
Set your Temp
Réglez la température



Configura la tua
i.Am come vuoi tu
Configure your
i.Am as you wish
Configurez votre
i.Am comme vous
le souhaitez



65*
48*
24*



GA89430001
MAX 1 - 130^Δ

GA89430001
MAX 2 - 195^Δ

GA89430001
MAX 3 - 260^Δ
(DUAL VENT)
MAX 2 - 260^Δ

GA89430002
MAX 3 - 144^Δ
(DUAL VENT)
MAX 2 - 144^Δ

GA89430007
MAX 2 - 72^Δ

GA89430007
MAX 3 - 96^Δ

GA89430007
MAX 6 - 192^Δ

14*
7*
5*



GA8921*001
MAX 6 - 84^Δ

GA8921*001
MAX 10 - 140^Δ

GA8921*001
MAX 13 - 182^Δ
(DUAL VENT)
MAX 12 - 168^Δ

GA8921*019
MAX 13 - 91^Δ
(DUAL VENT)
MAX 12 - 84^Δ

GA8921*026
MAX 10 - 50^Δ

GA8921*026
MAX 13 - 65^Δ

GA8921*026
MAX 26 - 130^Δ

27*



GA8921*014
MAX 2 - 54^Δ

GA8921*014
MAX 3 - 81^Δ

GA8921*014
MAX 4 - 108^Δ

40*
24*
18*



GA89330002
MAX 2 - 80^Δ

GA89330002
MAX 3 - 120^Δ

GA89330002
MAX 4 - 160^Δ

GA89330001
MAX 4 - 96^Δ

GA89330003
MAX 3 - 54^Δ

GA89330003
MAX 4 - 72^Δ

GA89330003
MAX 8 - 144^Δ



Perché i.Am ti assicura il massimo risparmio energetico?

i.Am nasce dall'innovazione migliore. È costituita da una rivoluzionaria costruzione monoscocca, dal rivestimento 100% in materiale riciclato e riciclabile, con straordinarie caratteristiche di solidità e inerzia termica. La porta in vetrocamera è composta da un doppio vetro temperato a bassa emissività e alto isolamento. Queste caratteristiche garantiscono un isolamento eccezionale e una massima riduzione della dispersione, per consumi di esercizio estremamente bassi (fino al -60% rispetto alle cantinette vino standard).

How does i.Am guarantee maximum energy saving?

i.Am incorporates the latest, most innovative technology. It features a revolutionary, single-piece body, coverings in 100% recycled and recyclable material, and amazing robustness and thermal inertia. The double-glazed door contains low-emissivity tempered glass and thick insulation. This ensures exceptional insulation and minimum thermal dispersion, resulting in extremely low consumption (up to 60% less than conventional wine displays).

Pourquoi i.Am vous assure-t-elle un maximum d'économies d'énergie?

i.Am est le fruit de l'excellence en matière d'innovation. Elle se caractérise par une construction monocoque révolutionnaire, avec un revêtement 100 % en matériau recyclé et recyclable, et présente des caractéristiques de solidité et d'inertie thermique extraordinaires. La porte à double vitrage est composée d'un double verre trempé à faible émissivité et à haute isolation. Ces caractéristiques assurent une isolation exceptionnelle et une réduction maximale de la dispersion thermique, pour une consommation de fonctionnement extrêmement faible (jusqu'à -60 % par rapport aux caves à vin standard).



Refrigerazione MULTI-ZONA

La versione con refrigerazione statica permette di ottenere nella stessa unità quattro temperature diverse (dai 2° ai 18°), così da esporre alla temperatura ideale vini anche molto diversi tra loro

MULTI-ZONE refrigeration

The static refrigeration version lets you set four different temperatures inside the same cabinet (from 2° to 18°), so that you can display even very different wines at the ideal temperature.

Réfrigération MULTI-ZONE

La version à réfrigération statique permet d'obtenir quatre températures différentes (de 2 °C à 18 °C) dans le même appareil, de sorte que même des vins très différents peuvent être exposés à la température idéale.



Minima rumorosità

La refrigerazione a condensazione statica riduce al minimo (solo 38dB) l'inquinamento acustico provocato dall'impianto refrigerante.

Low noise operation

A static condenser means minimal noise (only 38 dB) from the refrigeration system.

Bruit réduit

La réfrigération à condensation statique réduit au minimum (seulement 38 dB) le bruit provoqué par le système réfrigérant.



Vetro interno a bassa emissività
Low emission internal glass
Verre à faible émissivité



Costruzione monoscocca
Single-piece construction
Construction monocoque



Refrigerazione MONO-ZONA

La versione con refrigerazione ventilata permette di scegliere la temperatura uniforme interna che si preferisce, dai 2° ai 18°.

SINGLE ZONE refrigeration

Ventilated versions let you select the uniform temperature you want, from 2° to 18° C.

Réfrigération MONO-ZONE

La version avec réfrigération ventilée permet de choisir la température uniforme intérieure souhaitée, de 2° à 18° C.



Oltre a essere riciclato e riciclabile, il materiale di i.Am è anti-impronta, facile da pulire e resistente agli urti.

The material i.Am is made from is fully recycled and recyclable, and is finger-mark resistant, easy to clean and impact resistant too.

Le matériau utilisé pour la fabrication de i.Am est non seulement recyclé et recyclable, mais il est également anti-empreintes, facile à nettoyer et résistant aux chocs.



			 MAX	Code	Euro
IAM STD	H1200	MULTIZONA	130	S1S1N*	3.685
IAM STD	H1200	VENTILATA	130	S1V1N*	3.895
IAM STD	H1600	MULTIZONA	195	M1S1N*	3.895
IAM STD	H1600	VENTILATA	195	M1V1N*	4.110
IAM STD	H2000	MULTIZONA	260	L1S1N*	4.585
IAM STD	H2000	VENTILATA	260	L1V1N*	4.255
IAM STD	H2000	VENTILATA TROPICALIZZATA	260	L1W1N*	4.585
IAM STD DUALVENT	H2000	DUALVENT VENTILATA	260	L2V1N*	5.175
IAM FIT	H2000	MULTIZONA	144	B1S1N*	3.915
IAM FIT	H2000	VENTILATA	144	B1V1N*	4.125
IAM FIT	H2000	VENTILATA TROPICALIZZATA	144	B1W1N*	4.450
IAM FIT DUALVENT	H2000	DUALVENT VENTILATA	144	B2V1N*	5.080
IAM FIT SLIM	H1600	MULTIZONA	72	N1S1N*	3.800
IAM FIT SLIM	H1600	VENTILATA	72	N1V1N*	3.960
IAM FIT SLIM	H1600	VENTILATA TROPICALIZZATA	72	N1W1N*	4.180
IAM FIT SLIM	H2000	MULTIZONA	96	F1S1N*	3.865
IAM FIT SLIM	H2000	VENTILATA	96	F1V1N*	4.045
IAM FIT SLIM	H2000	VENTILATA TROPICALIZZATA	96	F1W1N*	4.310
IAM FIT SLIM DOPPIA	H2000	MULTIZONA	192	H1S1N*	7.470
IAM FIT SLIM DOPPIA	H2000	VENTILATA	192	H1V1N*	7.740
IAM FIT SLIM DOPPIA	H2000	VENTILATA TROPICALIZZATA	192	H1W1N*	8.480



Kit illuminazione led luce calda verticale
Lighting kit led warm light vertical

Kit éclairage led lumière chaude verticale

OPTIONAL

	Code	Euro
Ripiano fisso (portabottiglie) - Fixed shelf (bottle holder) i.Am STD	GA89430001	60
Ripiano fisso (portabottiglie) - Fixed shelf (bottle holder) i.Am FIT	GA89430002	55
Ripiano fisso (portabottiglie) - Fixed shelf (bottle holder) i.Am FIT SLIM	GA89430007	55
Cassetto estraibile - Removable drawers lying bottles i.Am STD	GA8921*001	200
Cassetto estraibile - Removable drawers lying bottles i.Am FIT	GA8921*019	165
Cassetto estraibile - Removable drawers lying bottles i.Am FIT SLIM	GA8921*026	165
Cassetto estraibile bottiglie verticali i.Am STD	GA8921*014	580
Kit tubi neri bottiglie inclinate 16° - Kit black tubes inclined bottles i.Am STD	GA89330002	180
Kit tubi neri bottiglie inclinate 16° - Kit black tubes inclined bottles i.Am FIT	GA89330001	135
Kit tubi neri bottiglie inclinate 16° - Kit black tubes inclined bottles i.Am FIT SLIM	GA89330003	135
* Supporto modulare porta cassetti/ripiani - Modular support for drawers - shelves i.Am h2000	M28909N003	45
* Supporto modulare porta cassetti/ripiani - Modular support for drawers - shelves i.Am h1600	M28909N005	45
* Supporto modulare porta cassetti/ripiani - Modular support for drawers - shelves i.Am h1200	M28909N006	40
* Supporto modulare porta cassetti/ripiani - Modular support for drawers - shelves i.Am h2000 dualvent	M28909N014	40
Kit illuminazione led luce calda verticale - Lighting kit led warm light vertical i.Am h2000	GE89590010	280
Kit illuminazione led luce calda verticale - Lighting kit led warm light vertical i.Am h1600	GE89590011	255
Kit illuminazione led luce calda verticale - Lighting kit led warm light vertical i.Am h1200	GE89590012	210
Kit illuminazione led luce calda verticale - Lighting kit led warm light vertical i.Am h2000 dualvent	GE89590015	435
Dimmer controllo LED con telecomando - Led control dimmer with remote control	EL89590004	105
Valvola altimetrica vetrocamera - Double glazing pressure equalisation valve - VANNE ALTIMÉTRIQUE DOUBLE VITRAGE (>900 slim)	OPT36005	380

T.A. 30°C - U.R. 55%
CLIMATE CLASS 4

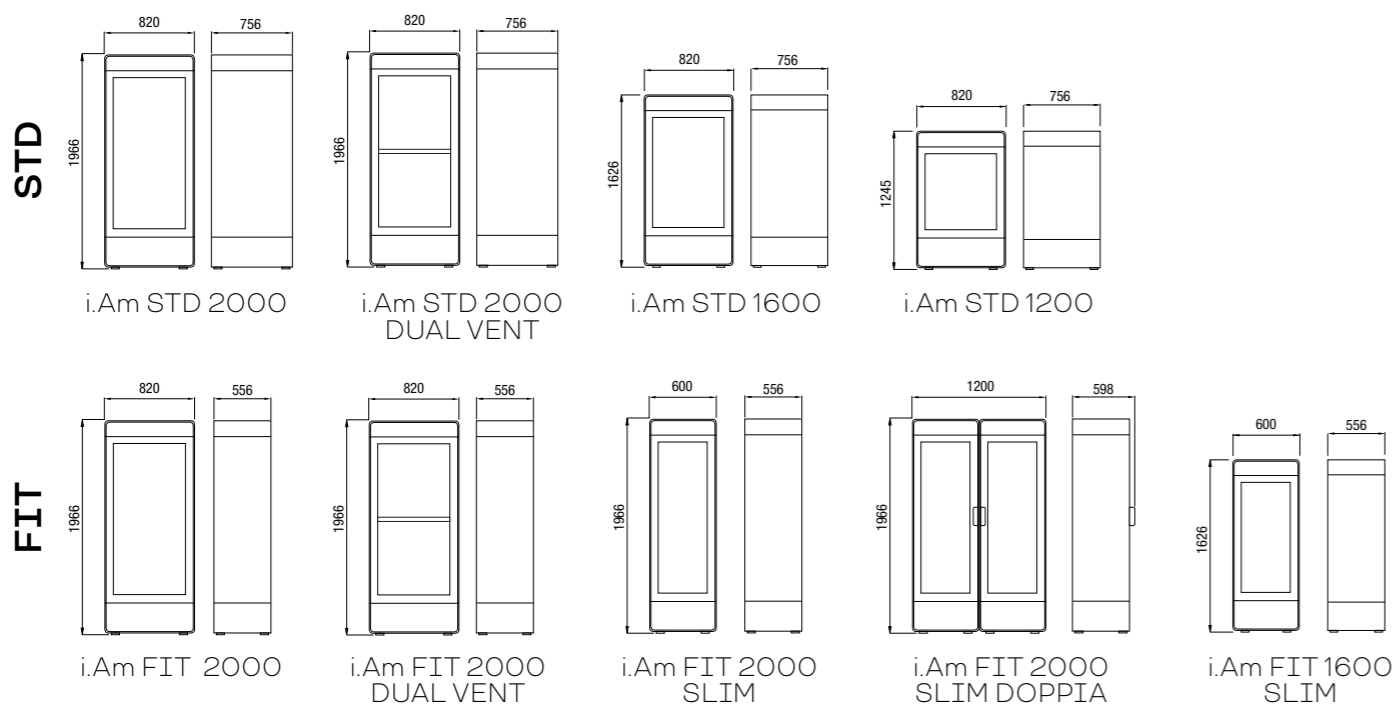

Codice - Code - Code

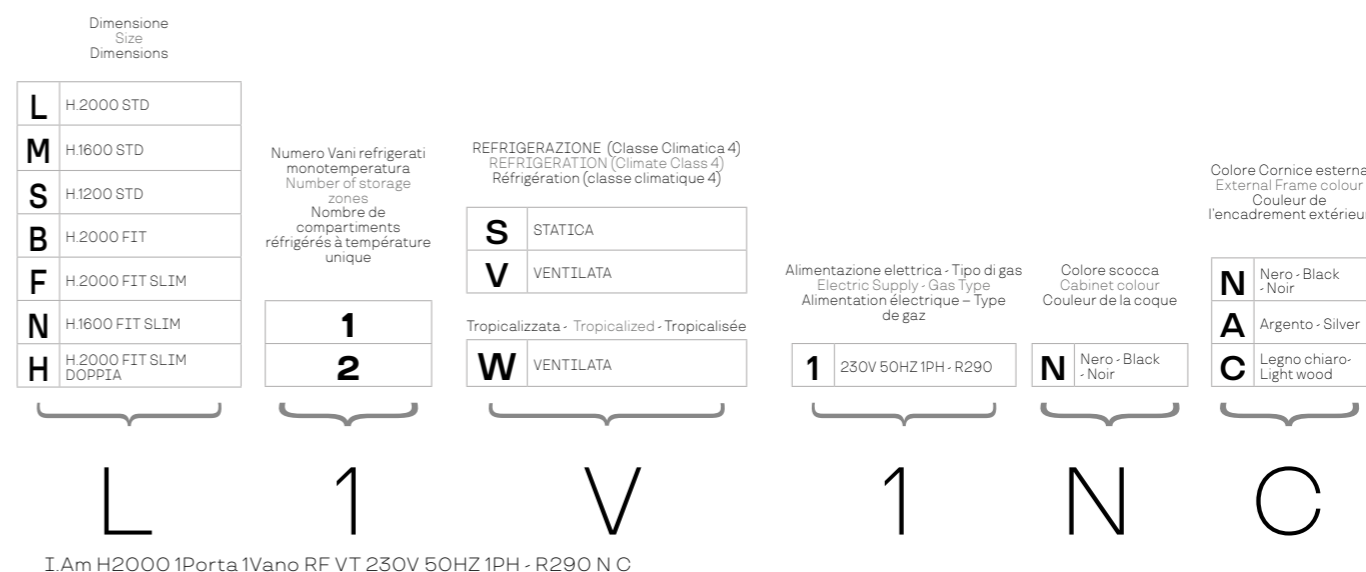

i.Am[®]

CONSERVATORE

L'ambiente perfetto
per affinare il tuo vino

The perfect
environment for
ageing your wine

L'environnement idéal
pour affiner votre vin

enofrigo[®]

i.Am® Conservatore

Le condizioni ideali per far maturare le bottiglie di pregio

Vuoi conservare al meglio i tuoi vini preferiti, così da permettere a tutti i loro aromi tipici di sprigionarsi nel pieno della loro potenza? Nato dalla linea i.Am di Enofrigo, Conservatore è la cantinetta che garantisce rispetto, cura estetica e massimo risparmio energetico.



Sistema di umidificazione

Questo sistema assicura l'atmosfera interna più pura e protettiva per i vini, mantenendo dei livelli di umidità perfettamente equilibrati.

Humidification system

This system maintains a pure atmosphere inside the cabinet, with exactly the right degree of humidity to protect your wines.

Système d'humidification

Ce système assure une atmosphère intérieure la plus pure et la plus protectrice pour les vins, tout en maintenant des niveaux d'humidité parfaitement équilibrés.

Ideal conditions for ageing quality wine in the bottle

Do you want to age your favourite wines and enjoy their typical flavour and aroma to the full? A recent addition to Enofrigo's i.Am line, the Conservatore display cabinet cares for your wines, presents them attractively and saves energy too.



Filtri a carboni attivi

Per un contesto completamente privo di odori.

Active carbon filters

For odour-free storage conditions.

Filtres à charbon actif

Pour un environnement totalement inodore.

Les conditions idéales pour la maturation des bouteilles d'exception

Vous souhaitez conserver vos vins de prédilection de la meilleure façon possible, pour leur permettre de révéler leurs meilleurs arômes? Né de la ligne i.Am d'Enofrigo, Conservatore est la cave à vin qui garantit à la fois respect, soin esthétique et un maximum d'économie d'énergie.



Sistema antivibrante

In questo modo si azzerano le vibrazioni dannose e si tutelano le bottiglie.

Anti-vibration system

Eliminates harmful vibration and keeps your bottles safe.

Système anti-vibration

Adieu les vibrations nuisibles, grâce à ce système, vos bouteilles sont protégées.



Porta-vetro oscurata

La porta della cantinetta è in vetrocamera completamente oscurata, per una massima protezione dalle radiazioni luminose e una piacevole continuità estetica con il corpo della vetrina.

Dark glass door

The double-glazed door features dark glass to protect your wine against the light and create a pleasing continuity between the door and the cabinet body.

Porte en verre teinté

La porte de la cave à vin est en double vitrage entièrement teinté, gage d'une protection maximale contre les rayonnements lumineux qui assure une parfaite continuité esthétique avec le corps de la vitrine.



Temperature dai 12° ai 18°C

La temperatura interna è uniforme e si può scegliere quella preferita all'interno del range ideale per la maturazione del vino.

Temperature from 12° to 18°C

Interior temperature is perfectly uniform and can be set to any value within the ideal range for wine ageing.

Températures de 12 °C à 18 °C

La température interne est uniforme et vous pouvez sélectionner la température de votre choix dans la plage idéale pour la maturation du vin.



Illuminazione a led soffusa

L'illuminazione a led interna, attivabile con interruttore, è particolarmente soffusa, così da rendere ben visibili anche le etichette disposte nei cassetti più bassi senza creare disturbo alle bottiglie.

Diffused LED lighting

The LED interior lighting can be switched on and off as needed, and is cleverly diffused to ensure that even the labels of wines in the bottom drawers are easily visible without having to move bottles.

Éclairage à LED tamisé

L'éclairage intérieur à LED, qui peut être activé à l'aide d'un interrupteur, est idéalement tamisé, de sorte que même les étiquettes des bouteilles des tiroirs inférieurs restent parfaitement visibles sans causer la moindre gêne.



La gamma

Dal modello standard, che ospita fino a 165 bottiglie, al più sottile e compatto, che ne conserva al massimo 43, con 2 diverse altezze e più varianti di larghezza e profondità, Conservatore si adatta a tutte le esigenze espositive dei locali contemporanei.

The range

Conservatore adapts to all display requirements in contemporary catering. The standard model holds up to 165 bottles while the most slender and compact model holds up to 43. Cabinets come in 2 different heights and in various widths and depths.

La gamme

Du modèle standard, qui peut loger jusqu'à 165 bouteilles, au modèle le plus fin et le plus compact, qui peut contenir un maximum de 43 bouteilles, avec 2 hauteurs différentes et plusieurs largeurs et profondeurs, Conservatore s'adapte à toutes les exigences de présentation des établissements contemporains.



RECYCLED
RECYCLABLE

Oltre a essere riciclato e riciclabile, il materiale della cantina è anti-impronta, facile da pulire e resistente agli urti.

The cabinet is made from fully recycled and recyclable material that is also finger-mark resistant, easy to clean and impact resistant.

En plus d'être recyclé et recyclable, le matériau utilisé pour la fabrication de la cave à vin est également anti-empres, facile à nettoyer et résistant aux chocs.



Massima silenziosità

Gli accorgimenti tecnici adottati garantiscono una silenziosità senza precedenti del sistema di condensazione. In questo modo, Conservatore si può collocare anche in un ambiente intimo garantendo il massimo comfort ai presenti.

Super-silent

Advanced design means that the display's condensing system is quieter than ever before. This allows Conservatore to be positioned even in the most intimate settings without disturbing guests.

Silence maximum

Les solutions techniques adoptées garantissent un silence sans précédent du système de condensation. Ainsi, Conservatore peut également trouver sa place dans un cadre intime, garantissant un confort maximal pour les personnes présentes.



Risparmio energetico

La struttura della cantinetta è costituita da polimeri plastici al 100% riciclati e riciclabili. Le performance tecnologiche della linea permettono di abbattere i consumi e di ottenere un risparmio energetico importante (Conservatore consuma fino al 60% in meno rispetto a una cantinetta standard).

Energy saving

The body of the cabinet is made from 100% recycled and recyclable plastic polymers. Excellent technical performance reduces consumption and delivers significant energy savings (Conservatore consumes up to 60% less than a standard display cabinet).

Économie d'énergie

La cave à vin a une structure en polymères plastiques 100 % recyclés et recyclables. Les performances technologiques de la ligne permettent de réduire considérablement la consommation d'énergie et de réaliser d'importantes économies (Conservatore consomme jusqu'à 60 % de moins qu'une cave à vin classique).



Colori

La struttura del mobile è di colore nero. La cornice della porta è in legno con finitura Silver (A), Black (N) o Light Wood (C). Nel caso di cassetti interni i frontali in legno sono coordinati con la cornice esterna.

Silver



Black



Light wood



Colour options

The cabinet's structure is black in colour. The door surround is in wood with a Silver (A), Black (N) or Light Wood (C) finish. If drawers are fitted internally, their wood fronts match the outside surround.

Coloris

La structure du meuble est noire. Le cadre de la porte est en bois avec une finition Argent (A), Noir (N) ou Bois clair (C). Si des tiroirs intérieurs sont présents, les panneaux frontaux en bois sont coordonnés au cadre extérieur.

H2000



75
cm

82
cm

165* MAX

FIT H2000



55
cm

82
cm

82* MAX

FIT SLIM
H2000



60
cm

58* MAX

FIT SLIM
H1600



55
cm

60
cm

43* MAX

Scegli la configurazione interna che preferisci

A seconda delle tue esigenze, puoi decidere quale layout interno adottare.

I cassetti

I cassetti per la conservazione dei vini sono in metallo, con supporti plastici per l'alloggiamento delle bottiglie e frontalino in legno coordinato al colore della cornice esterna scelta. Le bottiglie si conservano coricate in orizzontale, cosicché i tappi in sughero, dove presenti, possano mantenersi sempre umidi. La robustezza delle guide e la qualità dei materiali adottati garantiscono anche in caso di peso importante delle bottiglie. Per accontentare le diverse esigenze, le culle sono previste con distanze differenti, così da ospitare bottiglie Bordeaux e Bourgogne.

Bordeaux
Bordelaise



Layout interni
H2000

D
Bordeaux

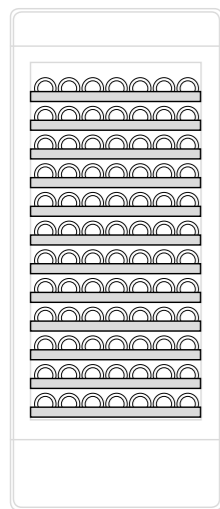

Choose your preferred interior layout

You can decide on interior layout to suit your needs.

Drawers

Wine storage drawers are made from metal with plastic cradles and a wooden front that matches the colour of the outside surround. Bottles are stored horizontally to keep organic corks, if present, wet at all times. Robust runners and top-quality materials guarantee safe and easy action even with x heavy load of bottles. To satisfy all possible needs, cradles come with different spacings, allowing them to house both Bordelaise and Burgundy bottles.

Bourgogne
Burgundy
Bourguignonnes



Interior layouts
H2000

L
Bourgogne

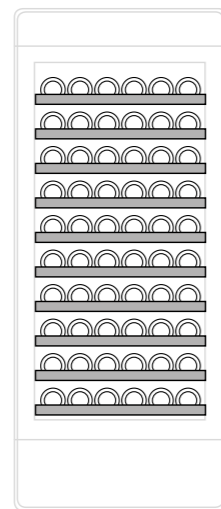

Choisissez votre configuration interne favorite

En fonction de vos besoins, vous pouvez décider de la disposition interne à adopter.

Les tiroirs

Les tiroirs de conservation de vin sont en métal, avec des supports en plastique pour ranger les bouteilles et un panneau frontal en bois assorti à la couleur du cadre extérieur choisi. Les bouteilles sont stockées couchées à l'horizontale, de manière à ce que les bouchons de liège, le cas échéant, puissent toujours rester humides. Les glissières et la qualité des matériaux utilisés garantissent une robustesse à toute épreuve, même si les bouteilles sont lourdes. Pour répondre aux différents besoins, les clayettes sont proposées avec des divers espacements, de manière à pouvoir accueillir des bouteilles bordelaises et bourguignonnes.

Aménagements intérieurs
H2000

MIX
Bordeaux + Bourgogne

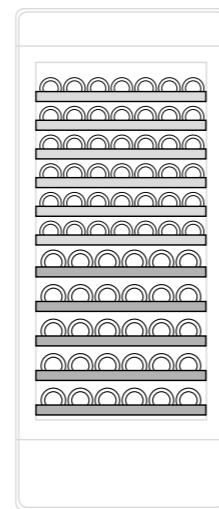

i.Am Conservatore STD 2000

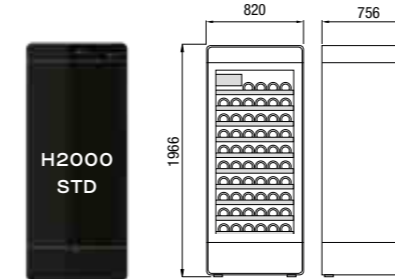

			CASSETTI DRAWERS TIROIRS	MAX BORDEAUX BORDELAISE	MAX BOURGOGNE BURGUNDY BOURGUIGNONNES	Code	Euro
IAM CONSERVATORE	H2000	D	12	165	-	U1N1D*	8.185
IAM CONSERVATORE	H2000	L	10	-	120	U1N1L*	7.695
IAM CONSERVATORE	H2000	MIX	6+5	81	60	U1N1M*	7.935

i.Am Conservatore FIT 2000

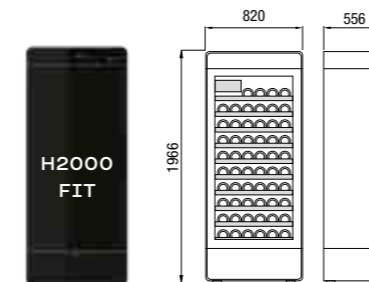

			CASSETTI DRAWERS TIROIRS	MAX BORDEAUX BORDELAISE	MAX BOURGOGNE BURGUNDY BOURGUIGNONNES	Code	Euro
IAM CONSERVATORE FIT	H2000	D	12	82	-	R1N1D*	7.230
IAM CONSERVATORE FIT	H2000	L	10	-	60	R1N1L*	6.955
IAM CONSERVATORE FIT	H2000	MIX	6+5	40	30	R1N1M*	7.115

i.Am Conservatore FIT SLIM 2000

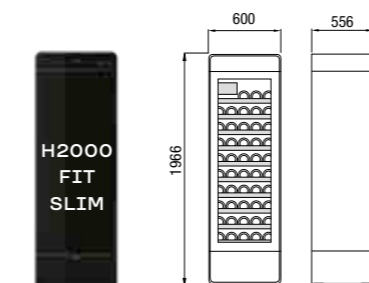

			CASSETTI DRAWERS TIROIRS	MAX BORDEAUX BORDELAISE	MAX BOURGOGNE BURGUNDY BOURGUIGNONNES	Code	Euro
IAM CONSERVATORE FIT SLIM	H2000	D	12	58	-	P1N1DN*	6.890
IAM CONSERVATORE FIT SLIM	H2000	L	10	-	40	P1N1LN*	6.935
IAM CONSERVATORE FIT SLIM	H2000	MIX	6+5	28	20	P1N1MN*	6.935

i.Am Conservatore FIT SLIM 1600

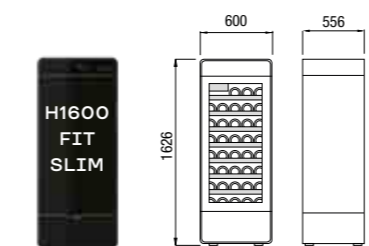

			CASSETTI DRAWERS TIROIRS	MAX BORDEAUX BORDELAISE	MAX BOURGOGNE BURGUNDY BOURGUIGNONNES	Code	Euro
IAM CONSERVATORE FIT SLIM	H1600	D	9	43	-	T1N1DN*	6.850
IAM CONSERVATORE FIT SLIM	H1600	L	7	-	28	T1N1LN*	6.850
IAM CONSERVATORE FIT SLIM	H1600	MIX	4+4	18	16	T1N1MN*	6.850



Dati tecnici

Technical data
Données techniques

TRASPORTO / PACKAGING

TRANSPORT / PACKAGING

TRANSPORT/EMBALLAGE

P.N. (NET PRICE)
EURO

CONTRIBUTO TRASPORTO ITALIA PER COLLO (ECCEP TO WINE LIBRARY)			al costo
CONTRIBUTO TRASPORTO ITALIA ESPRESSO PER COLLO (ECCEP TO WINE LIBRARY)			al costo
CONTRIBUTO TRASPORTO ITALIA PER WINE LIBRARY			
CONTRIBUTO TRASPORTO ITALIA ESPRESSO PER WINE LIBRARY			
CONTRIBUTO SPONDA IDRAULICA CONSEGNA ITALIA			70
SACCO BARRIERA ANTIPIOGGIA / COLLO			70
CONTRIBUTO TRASPORTO ITALIA CALOTTA			al costo
CONTRIBUTO TRASPORTO ITALIA - BASE HOT			al costo
CONTRIBUTO TRASPORTO ITALIA PER ISOLE MINORI - ZONE DISAGIATE - ZONE A TRAFFICO LIMITATO (ZTL)			al costo
IMBALLO CASSA CALOTTA	CANOPY WOODEN CASE	EMBALLAGE POUR SUPERSTRUCTURE	75
IMBALLO CASSA PER VETRI ECC.	GLASSES REINFORCED PACKAGE	EMBALLAGE POUR GLACES	75
IMBALLO SU GABBIA	WOODEN CAGE	CAGE EN BOIS	150
IMBALLO SU GABBIA PER WINE LIBRARY (2 COLLI)	WINE LIBRARY WOODEN CAGE (2 PACKAGES)	CAGE EN BOIS PUOS WINE LIBRARY - OBLIGATOIRE ET NECESSAIRE	260+150

Nel caso di sovrastrutture in vetro è consigliabile la gabbia in legno per il trasporto

With glass upperstructure we suggest to deliver good with wooden cage

Dans le cas de superstructures en verre, il est recommandé d'utiliser une cage en bois pour le transport.

▲ Il prodotto ENOGALAX H2400 viene trasportato orizzontale con imballo su gabbia
ENOGALAX H2400 is shipped horizontally and with wooden cage

WINE LIBRARY

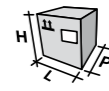
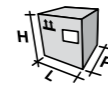
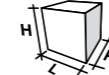

Model	Version	Code	Euro 2022	(TA 30°C - 55% UR)	Capacity Bordeaux		Watt	volt/Ph/Hz	Width	Depth	Height	Weight	Package A					Package B					Total Pack Weight	Total Pack Volume			
					(Lt)	(UPTO)							(PZ)	Width	Depth	Height	Weight	Vol.A	(PZ)	Width	Depth	Height			Weight	Vol.B	
									mm	mm	mm	kg	mm	mm	mm	kg	mc	mm	mm	mm	kg	mc	kg	mc			
WINE LIBRARY 20 4V 2P H2200 VT 230V 50 HZ 1PH LAM*	4V	H220 P60	A1WE2BV5*	20.960	+4/+18	886	336	1000	230/1/50	1450	670	2150	440	1	1570	810	1850	320	2,35	1	1650	860	750	150	1,06	470	3,41
WINE LIBRARY 20 4V 2P H2600 VT 230V 50 HZ 1PH LAM*	4V	H260 P60	A1WE2HV5*	22.905	+4/+18	1114	420	1000	230/1/50	1450	670	2550	480	1	1570	810	2200	350	2,80	1	1650	860	750	150	1,06	500	3,86
WINE LIBRARY 20 ISLAND 2P H2200 VT 230V 50 HZ 1PH LAM*	ISLAND	H220 P60	A1WI2BV5*	17.605	+4/+18	914	336	940	230/1/50	1450	670	2150	400	1	1570	810	1850	320	2,35	1	1650	860	750	150	1,06	470	3,41
WINE LIBRARY 20 ISLAND 2P H2600 VT 230V 50 HZ 1PH LAM*	ISLAND	H260 P60	A1WI2HV5*	18.735	+4/+18	1150	420	940	230/1/50	1450	670	2550	440	1	1570	810	2200	350	2,80	1	1650	860	750	150	1,06	500	3,86
WINE LIBRARY 20 WALL 2P H2200 VT 230V 50 HZ 1PH LAM*	WALL	H220 P60	A1WW2BV5*	16.105	+4/+18	914	336	900	230/1/50	1450	630	2150	360	1	1570	810	1850	320	2,35	1	1650	860	750	150	1,06	470	3,41
WINE LIBRARY 20 WALL 2P H2600 VT 230V 50 HZ 1PH LAM*	WALL	H260 P60	A1WW2HV5*	17.635	+4/+18	1150	420	900	230/1/50	1450	630	2550	400	1	1570	810	2200	350	2,80	1	1650	860	750	150	1,06	500	3,86
WINE LIBRARY 20 3V DX 2P H2200 VT 230V 50 HZ 1PH LAM*	3V DX	H220 P60	A1WD2BV5*	19.410	+4/+18	914	336	970	230/1/50	1450	670	2150	420	1	1570	810	1850	320	2,35	1	1650	860	750	150	1,06	470	3,41
WINE LIBRARY 20 3V DX 2P H2600 VT 230V 50 HZ 1PH LAM*	3V DX	H260 P60	A1WD2HV5*	20.540	+4/+18	1150	420	970	230/1/50	1450	670	2550	460	1	1570	810	2200	350	2,80	1	1650	860	750	150	1,06	500	3,86
WINE LIBRARY 20 3V SX 2P H2200 VT 230V 50 HZ 1PH LAM*	3V SX	H220 P60	A1WS2BV5*	19.410	+4/+18	914	336	970	230/1/50	1450	670	2150	420	1	1570	810	1850	320	2,35	1	1650	860	750	150	1,06	470	3,41
WINE LIBRARY 20 3V SX 2P H2600 VT 230V 50 HZ 1PH LAM*	3V SX	H260 P60	A1WS2HV5*	20.540	+4/+18	1150	420	970	230/1/50	1450	670	2550	460	1	1570	810	2200	350	2,80	1	1650	860	750	150	1,06	500	3,86
WINE LIBRARY 20 2V DX 2P H2200 VT 230V 50 HZ 1PH LAM*	2V DX	H220 P60	A1WR2BV5*	17.920	+4/+18	914	336	930	230/1/50	1450	630	2150	380	1	1570	810	1850	320	2,35	1	1650	860	750	150	1,06	470	3,41
WINE LIBRARY 20 2V DX 2P H2600 VT 230V 50 HZ 1PH LAM*	2V DX	H260 P60	A1WR2HV5*	19.450	+4/+18	1150	420	930	230/1/50	1450	630	2550	420	1	1570	810	2200	350	2,80	1	1650	860	750	150	1,06	500	3,86
WINE LIBRARY 20 2V SX 2P H2200 VT 230V 50 HZ 1PH LAM*	2V SX	H220 P60	A1WL2BV5*	17.920	+4/+18	914	336	930	230/1/50	1450	630	2150	380	1	1570	810	1850	320	2,35	1	1650	860	750	150	1,06	470	3,41
WINE LIBRARY 20 2V SX 2P H2600 VT 230V 50 HZ 1PH LAM*	2V SX	H260 P60	A1WL2HV5*	19.450	+4/+18	1150	420	930	230/1/50	1450	630	2550	420	1	1570	810	2200	350	2,80	1	1650	860	750	150	1,06	500	3,86
WINE LIBRARY 20 3V SX-DX 2P H2200 VT 230V 50 HZ 1PH LAM*	3V SX-DX	H260 P60	A1WF2BV5*	19.735	+4/+18	914	336	930	230/1/51	1450	630	2150	420	1	1570	810	1850	320	2,35	1	1650	860	750	150	1,06	500	3,41
WINE LIBRARY 20 3V SX-DX 2P H2600 VT 230V 50 HZ 1PH LAM*	3V SX-DX	H260 P60	A1WF2HV5*	21.265	+4/+18	1150	420	930	230/1/52	1450	630	2550	420	1	1570	810	2200	350	2,80	1	1650	860	750	150	1,06	500	3,86
WINE LIBRARY 20 4V 2P H2200 UR 230V 50 HZ 1PH LAM*	4V	H220 P60	A1WE2BU5*	22.140	+4/+18	886	336	1000	230/1/50	1450	670	2150	440	1	1570	810	1850	320	2,35	1	1650	860	750	150	1,06	470	3,41
WINE LIBRARY 20 4V 2P H2600 UR 230V 50 HZ 1PH LAM*	4V	H260 P60	A1WE2HU5*	24.100	+4/+18	1114	420	1000	230/1/50	1450	670	2550	480	1	1570	810	2200	350	2,80	1	1650	860	750	150	1,06	500	3,86
WINE LIBRARY 20 ISLAND 2P H2200 UR 230V 50 HZ 1PH LAM*	ISLAND	H220 P60	A1WI2BU5*	18.785	+4/+18	914	336	940	230/1/50	1450	670	2150	400	1	1570	810	1850	320	2,35	1	1650	860	750	150	1,06	470	3,41
WINE LIBRARY 20 ISLAND 2P H2600 UR 230V 50 HZ 1PH LAM*	ISLAND	H260 P60	A1WI2HU5*	19.915	+4/+18	1150	420	940	230/1/50	1450	670	2550	440	1	1570	810	2200	350	2,80	1	1650	860	750	150	1,06	500	3,86
WINE LIBRARY 20 WALL 2P H2200 UR 230V 50 HZ 1PH LAM*	WALL	H220 P60	A1WW2BU5*	17.300	+4/+18	914	336	900	230/1/50	1450	630	2150	360	1	1570	810	1850	320	2,35	1	1650	860	750	150	1,06	470	3,41
WINE LIBRARY 20 WALL 2P H2600 UR 230V 50 HZ 1PH LAM*	WALL	H260 P60	A1WW2HU5*	18.830	+4/+18	1150	420	900	230/1/50	1450	630	2550	400	1	1570	810	2200	350	2,80	1	1650	860	750	150	1,06	500	3,86
WINE LIBRARY 20 3V DX 2P H2200 UR 230V 50 HZ 1PH LAM*	3V DX	H220 P60	A1WD2BU5*	20.600	+4/+18	914	336	970	230/1/50	1450	670	2150	420	1	1570	810	1850	320	2,35	1	1650	860	750	150	1,06	470	3,41
WINE LIBRARY 20 3V DX 2P H2600 UR 230V 50 HZ 1PH LAM*	3V DX	H260 P60	A1WD2HU5*	21.730	+4/+18	1150	420	970	230/1/50	1450	670	2550	460	1	1570	810	2200	350	2,80	1	1650	860	750	150	1,06	500	3,86
WINE LIBRARY 20 3V SX 2P H2200 UR 230V 50 HZ 1PH LAM*	3V SX	H220 P60	A1WS2BU5*	20.600	+4/+18	914	336	970	230/1/50	1450	670	2150	420	1	1570	810	1850	320	2,35	1	1650	860	750	150	1,06	470	3,41
WINE LIBRARY 20 3V SX 2P H2600 UR 230V 50 HZ 1PH LAM*	3V SX	H260 P60	A1WS2HU5*	21.730	+4/+18	1150	420	970	230/1/50	1450	670	2550	460	1	1570	810	2200	350	2,80	1	1650	860	750	150	1,06	500	3,86
WINE LIBRARY 20 2V DX 2P H2200 UR 230V 50 HZ 1PH LAM*	2V DX	H220 P60	A1WR2BU5*	19.105	+4/+18	914	336	930	230/1/50	1450	630	2150	380	1	1570	810	1850	320	2,35	1	1650	860	750	150	1,06	470	3,41
WINE LIBRARY 20 2V DX 2P H2600 UR 230V 50 HZ 1PH LAM*	2V DX	H260 P60	A1WR2HU5*	20.645	+4/+18	1150	420	930	230/1/50	1450	630	2550	420	1	1570	810	2200	350	2,80	1	1650	860	750	150	1,06	500	3,86
WINE LIBRARY 20 2V SX 2P H2200 UR 230V 50 HZ 1PH LAM*	2V SX	H220 P60	A1WL2BU5*	19.105	+4/+18	914	336	930	230/1/50	1450	630	2150	380	1	1570	810	1850	320	2,35	1	1650	860	750	150	1,06	470	3,41
WINE LIBRARY 20 2V SX 2P H2600 UR 230V 50 HZ 1PH LAM*	2V SX	H260 P60	A1WL2HU5*	20.645	+4/+18	1150	420	930	230/1/50	1450	630	2550	420	1	1570	810	2200	350	2,80	1	1650	860	750	150	1,06	500	3,86
WINE LIBRARY 20 3V SX-DX 2P H2200 VT 230V 50 HZ 1PH LAM*	3V SX-DX	H260 P60	A1WF2BU5*	20.915	+4/+18	914	336	930	230/1/51	1450	630	2150	420	1	1570	810	1850	320	2,35	1	1650	860	750	150	1,06	5000	3,41
WINE LIBRARY 20 3V SX-DX 2P H2600 VT 230V 50 HZ 1PH LAM*	3V SX-DX	H260 P60	A1WF2HU5*	22.445	+4/+18	1150	420	930	230/1/52	1450	630	2550	420	1	1570	810	2200	350	2,80	1	1650	860	750	150	1,06	500	3,86
WINE LIBRARY 20 4V 3P H2200 VT 230V 50 HZ 1PH LAM*	4V	H220 P60	A1WE3BV5*	28.805	+4/+18	1329	504	1400	230/1/50	2130	670	2150	610	1	2250	810	1850	480	3,37	1	2300	860	750	200	1,48	680	4,85
WINE LIBRARY 20 4V 3P H2600 VT 230V 50 HZ 1PH LAM*	4V	H260 P60	A1WE3HV5*	31.480	+4/+18	1671	630	1400	230/1/50	2130	670	2550	670	1	2250	810	2200	500	4,01	1	2300	860	750	200	1,48	700	5,49
WINE LIBRARY 20 ISLAND 3P H2200 VT 230V 50 HZ 1PH LAM*	ISLAND	H220 P60	A1WI3BV5*	26.660	+4/+18	1371	504	1350	230/1/50	2130	670	2150	570	1	2250	810	1850	480	3,37	1	2300	860	750	200	1,48	680	4,85
WINE LIBRARY 20 ISLAND 3P H2600 VT 230V 50 HZ 1PH LAM*	ISLAND	H260 P60	A1WI3HV5*	29.090	+4/+18	1725	630	1350	230/1/50	2130	670	2550	630	1	2250	810	2200	500	4,01	1	2300	860	750	200	1,48	700	5,49
WINE LIBRARY 20 WALL 3P H2200 VT 230V 50 HZ 1PH LAM*	WALL	H220 P60	A1WW3BV5*	23.860	+4/+18	1371	504	1300	230/1/50	2130	630	2150	520	1	2250	810	1850	480	3,37	1	2300	860	750	200	1,48	680	4,85
WINE LIBRARY 20 WALL 3P H2600 VT 230V 50 HZ 1PH LAM*	WALL	H260 P60	A1WW3HV5*	26.270	+4/+18	1725	630	1300	230/1/50	21																	

WINE LIBRARY



Model Version Code **Euro 2022** (TA 30°C - 55% UR) Capacity Bordeaux (Lt) (UP TO)

OPTIONAL

Versione (WL) predisposta per remotizzazione (senza unità) per il singolo vano Prearranged remotable (WL) version (without condensing unit) for the single refrigerated compartment - Version (WL) équipée pour la gestion à distance (sans unité de condensation) de chaque compartiment						
				OPT20001	-300	
Versione (WL) predisposta per remotizzazione (con unità fornita a parte - fino a 8 m orizzontali) per il singolo vano - Prearranged remotable (WL) version (with condensing unit supplied separately - up to 8 m level) for the single refrigerated compartment - Version (WL) équipée pour la gestion à distance (avec unité de condensation fournie séparément - jusqu'à 8 m horizontaux) de chaque compartiment						
				OPT20002	305	
OPZIONE COLORE LAMINATO SPECIALE	SPECIAL LAMINATED OPTIONAL COLOURS	OPTION COLORIS STRATIFIÉ SPÉCIAL	2P	OPT20009	1.130	
OPZIONE COLORE LAMINATO SPECIALE	SPECIAL LAMINATED OPTIONAL COLOURS	OPTION COLORIS STRATIFIÉ SPÉCIAL	3P	OPT20010	1.275	
LUCI LED TONALITA' FREDDA (5500-6500° K)	Cool white LED lighting (5500-6500° K)	Éclairage LED tonalité froide (5500-6500° K)	2P	OPT20016	135	NOT FOR RETROFIT
LUCI LED TONALITA' FREDDA (5500-6500° K)	Cool white LED lighting (5500-6500° K)	Éclairage LED tonalité froide (5500-6500° K)	3P	OPT20017	160	NOT FOR RETROFIT
DIMMER			2P	OPT20069	260	
DIMMER			3P	OPT20070	380	
RIVESTIMENTO INOX INTERNO (singolo vano)	STAINLESS STEEL INTERNAL (single compartment)	REVÊTEMENT INTERNE EN ACIER INOX (chaque compartiment)		OPT20020	1.565	
KIT ILLUMINAZIONE LED RGB H220 (singola porta)	LED LIGHTING KIT, RGB H220 (single door)	KIT D'ÉCLAIRAGE À LEDS RVB H220 (porte unique)		OPT20018	570	
KIT ILLUMINAZIONE LED RGB h260 (singola porta)	LED LIGHTING KIT, RGB H260 (single door)	KIT D'ÉCLAIRAGE À LEDS RVB H260 (porte unique)		OPT20019	695	
VALVOLA ALTIMETRICA VETRO-CAMERA (>900 slm) per il singolo vano	DOUBLE GLAZING PRESSURE EQUALISATION VALVE (>900 m.as) for the single refrigerated compartment	VANNE ALTIMÉTRIQUE DOUBLE VITRAGE (>900 slm) pour chaque compartiment		OPT36005	380	

WINE LIBRARY ALLESTIMENTO INTERNO - INTERNAL LAYOUT

R	Ripiano in acciaio / Stainless steel shelf	M220430006	M220430008	150	42
C	Supporti orizzontali in plexiglass / Pleaxiglass Horizontal supports	GK20080010	GK20080009	270	10
T	Tubi in acciaio / Stainless steel tubes	GK20330002	GK20330004	210	8
H	Gancio / Hook	CC00470014	CC00470014	35	-
K	Tubi in acciaio inclinati / Stainless steel cross sloping tubes	GK20330006	GK20330005	345	14
A	Tubi in acciaio inclinati / Stainless steel sloping tubes	GK20330009	GK20330010	250	28
P	Ripiano in plexiglass / Pleaxiglass shelf	MO20430003	MO20430001	270	-

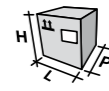
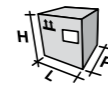
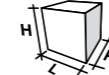

Model	Version	Code	Euro 2022	(TA 30°C - 55% UR)	Capacità Bordeaux (Lt) (UP TO)	Watt	volt/Ph/Hz	Width mm	Depth mm	Height mm	Weight kg	(PZ)	Package A Width mm	Package A Depth mm	Package A Height mm	Package A Weight kg	Vol.A mc	(PZ)	Package B Width mm	Package B Depth mm	Package B Height mm	Package B Weight kg	Vol.B mc	Total Pack Weight kg	Total Pack Volume mc	
ENOGALAX																										
Humidity control																										
Ripiani Shelves																										
H800 Monofacciale - Single side																										
DOOR H800	FAN ASSISTED	GM1C1V	6.680	+4/+18	3	181	68	300	230/1/50	837	641	878	110	1	920	750	1100	125	0,76					125	0,76	
DOOR H800	FAN ASSISTED	YES	GM1C1U	7.610	+4/+18	3	181	68	300	230/1/50	837	641	878	110	1	920	750	1100	125	0,76					125	0,76
H1200 Monofacciale - Single side																										
DOOR H800	FAN ASSISTED	GM2C1V	8.005	+4/+18	4	228	68	300	230/1/50	837	623	1232	135	1	920	750	1450	150	1					150	1	
DOOR H800	FAN ASSISTED	YES	GM2C1U	8.930	+4/+18	4	228	68	300	230/1/50	837	623	1232	135	1	920	750	1450	150	1					150	1
H1600 Monofacciale - Single side																										
DOOR H1600	FAN ASSISTED	GM3C1V	8.515	+4/+18	7	456	167	320	230/1/50	837	671	1646	185	1	920	750	1850	200	1,28					200	1,28	
DOOR H1600	FAN ASSISTED	YES	GM3C1U	9.435	+4/+18	7	456	167	320	230/1/50	837	671	1646	185	1	920	750	1850	200	1,28					200	1,28
H2000 Monofacciale - Single side																										
DOOR H1600	FAN ASSISTED	GM4C1V	9.920	+4/+18	8	517	192	340	230/1/50	837	623	2000	210	1	920	750	2200	230	1,52					230	1,52	
DOOR H1600	FAN ASSISTED	YES	GM4C1U	10.710	+4/+18	8	517	192	340	230/1/50	837	623	2000	210	1	920	750	2200	230	1,52					230	1,52
H2000 Monofacciale - Single side																										
DOOR H2000	FAN ASSISTED	GM5C1V	9.640	+4/+18	9	583	215	340	230/1/50	837	671	2000	205	1	920	750	2200	225	1,52					225	1,52	
DOOR H2000	FAN ASSISTED	YES	GM5C1U	10.725	+4/+18	9	583	215	340	230/1/50	837	671	2000	205	1	920	750	2200	225	1,52					225	1,52
H2400 Monofacciale - Single side																										
DOOR H2000	FAN ASSISTED	GM6C1V	10.845	+4/+18	10	650	240	390	230/1/50	837	623	2357	230	1	2500	800	1100	270	2,2					270	2,2	
DOOR H2000	FAN ASSISTED	YES	GM6C1U	11.875	+4/+18	10	650	240	390	230/1/50	837	623	2357	230	1	2500	800	1100	270	2,2					270	2,2
H800 Bifacciale - Double side																										
DOOR H800	FAN ASSISTED	GB1*1V	8.110	+4/+18	4	228	68	25	230/1/50	837	623	878	120	1	920	750	1100	135	0,76					135	0,76	
DOOR H800	FAN ASSISTED	YES	GB1*1U	8.795	+4/+18	4	228	68	25	230/1/50	837	623	878	120	1	920	750	1100	135	0,76					135	0,76
H1200 Bifacciale - Double side																										
DOOR H800	FAN ASSISTED	GB2C1V	8.780	+4/+18	4	228	68	300	230/1/50	837	623	1232	155	1	920	750	1450	170	1					170	1	
DOOR H800	FAN ASSISTED	YES	GB2C1U	9.700	+4/+18	4	228	68	300	230/1/50	837	623	1232	155	1	920	750	1450	170	1					170	1
H1600 Bifacciale - Double side																										
DOOR H1600	FAN ASSISTED	GB3*1V	9.870	+4/+18	8	517	192	30	230/1/50	837	623	1646	195	1	920	750	1850	210	1,28					210	1,28	
DOOR H1600	FAN ASSISTED	YES	GB3*1U	10.800	+4/+18	8	517	192	30	230/1/50	837	623	1646	195	1	920	750	1850	210	1,28					210	1,28
H2000 Bifacciale - Double side																										
DOOR H1600	FAN ASSISTED	GB4C1V	10.690	+4/+18	8	517	192	350	230/1/50	837	623	2000	230	1	920	750	2200	250	1,52					250	1,52	
DOOR H1600	FAN ASSISTED	YES	GB4C1U	11.615	+4/+18	8	517	192	350	230/1/50	837	623	2000	230	1	920	750	2200	250	1,52					250	1,52
H2000 Bifacciale - Double side																										
DOOR H2000	FAN ASSISTED	GB5*1V	10.965	+4/+18	10	650	240	35	230/1/50	837	623	2000	215	1	920	750	2200	235	1,52					235	1,52	
DOOR H2000	FAN ASSISTED	YES	GB5*1U	12.035	+4/+18	10	650	240	35	230/1/50	837	623	2000	215	1	920	750	2200	235	1,52					235	1,52
H2400 Bifacciale - Double side																										
DOOR H2000	FAN ASSISTED	GB6C1V	11.770	+4/+18	10	650	240	400	230/1/50	837	623	2357	250	1	2500	800	1100	290	2,2					290	2,2	
DOOR H2000	FAN ASSISTED	YES	GB6C1U	12.855	+4/+18	10	650	240	400	230/1/50	837	623	2357	250	1	2500	800	1100	290	2,2					290	2,2

OPTIONAL

OPZIONE COLORE LAMINATO SPECIALE - SPECIAL LAMINATED OPTIONAL COLOURS - OPTION COLORIS STRATIFIÉ SPÉCIAL H800-H1200	OPT87002	650	
OPZIONE COLORE LAMINATO SPECIALE - SPECIAL LAMINATED OPTIONAL COLOURS - OPTION COLORIS STRATIFIÉ SPÉCIAL H1600	OPT87003	785	
OPZIONE COLORE LAMINATO SPECIALE - SPECIAL LAMINATED OPTIONAL COLOURS - OPTION COLORIS STRATIFIÉ SPÉCIAL H2000-H2400	OPT87004	910	
VALVOLA ALTIMETRICA VETROCAMERA - DOUBLE GLAZING PRESSURE EQUALISATION VALVE - VANNE ALTIMÉTRIQUE DOUBLE VITRAGE (≥900 slim)	OPT36005	380	
DIMMER	OPT87006	160	NOT FOR RETROFIT
RIPIANO SINGOLO - SINGLE SHELF - ÉTAGÈRE SIMPLE	GA87430009R	170	
RIPIANO SINGOLO CON PIASTRE "QUARZO" - SINGLE SHELF WITH "QUARZO" INSERTS	GA87430011R	380	
CASSETTO ESTRAIBILE COMPLETO DI CULLE - REMOVABLE DRAWER WITH HORIZ. SUPPORTS	GA87210001	355	
KIT ILLUMINAZIONE LED RGB (singola porta) - LED LIGHTING KIT, RGB (single door) - KIT D'ÉCLAIRAGE À LEDS RVB (porte unique)	OPT87009	455	H800/H1200
KIT ILLUMINAZIONE LED RGB (singola porta) - LED LIGHTING KIT, RGB (single door) - KIT D'ÉCLAIRAGE À LEDS RVB (porte unique)	OPT20018	570	H1600
KIT ILLUMINAZIONE LED RGB (singola porta) - LED LIGHTING KIT, RGB (single door) - KIT D'ÉCLAIRAGE À LEDS RVB (porte unique)	OPT20019	695	H2000
KIT VASCHETTA SCIOGLI CONDENSA - CONDENSATE TRAY	OPT87011	350	

ENOGALAX MEAT

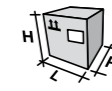
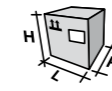
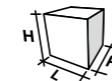

Model	Version	Code	Euro 2022	(TA 30°C - 55% UR)	Capacità (Lt)	Watt	volt/Ph/Hz	Width mm	Depth mm	Height mm	Weight kg	(PZ)	Width mm	Depth mm	Height mm	Weight kg	Vol.A mc	(PZ)	Width mm	Depth mm	Height mm	Weight kg	Vol.B mc	Total Pack Weight kg	Total Pack Volume mc	
ENOGALAX MEAT H800 Monofacciale - Single side																										
DOOR H800	Motore a bordo	MAN DX	GM1C1M	7.870	+2	164	310	230/1/50	837	665	878	110		916	750	1010	125	0,76						125	0,76	
DOOR H800	Motore a bordo	MAN SX	GM1C2M	7.870	+2	164	310	230/1/50	837	665	878	110		916	750	1010	125	0,76						125	0,76	
DOOR H800	Remoto	MAN DX	GM1P1M	7.710	+2	200	-	230/1/50	837	623	883	95		916	750	1010	110	0,76						110	0,76	
DOOR H800	Remoto	MAN SX	GM1P2M	7.710	+2	200	-	230/1/50	837	623	883	95		916	750	1010	110	0,76						110	0,76	
ENOGALAX MEAT H1200 Monofacciale - Single side																										
DOOR H800	Motore a bordo	MAN DX	GM2C1M	9.205	+2	200	310	230/1/50	837	623	1232	135		916	750	1365	150	1						150	1	
DOOR H800	Motore a bordo	MAN SX	GM2C2M	9.205	+2	200	310	230/1/50	837	623	1232	135		916	750	1365	150	1						150	1	
ENOGALAX MEAT H1600 Monofacciale - Single side																										
DOOR H1600	Motore a bordo	MAN DX	GM3C1M	9.700	+2	424	330	230/1/50	837	665	1646	185		916	750	1775	200	1,28						200	1,28	
DOOR H1600	Motore a bordo	MAN SX	GM3C2M	9.700	+2	424	330	230/1/50	837	665	1646	185		916	750	1775	200	1,28						200	1,28	
DOOR H1600	Remoto	MAN DX	GM3P1M	9.535	+2	460	-	230/1/50	837	623	1651	170		916	750	1775	185	1,28						185	1,28	
DOOR H1600	Remoto	MAN SX	GM3P2M	9.535	+2	460	-	230/1/50	837	623	1651	170		916	750	1775	185	1,28						185	1,28	
ENOGALAX MEAT H2000 Monofacciale - Single side																										
DOOR H1600	Motore a bordo	MAN DX	GM4C1M	10.980	+2	460	330	230/1/50	837	623	2000	210		916	750	2135	230	1,52						230	1,52	
DOOR H1600	Motore a bordo	MAN SX	GM4C2M	10.980	+2	460	330	230/1/50	837	623	2000	210		916	750	2135	230	1,52						230	1,52	
DOOR H2000	Motore a bordo	MAN DX	GM5C1M	10.985	+2	544	400	230/1/50	837	665	2000	205		916	750	2135	225	1,52						225	1,52	
DOOR H2000	Motore a bordo	MAN SX	GM5C2M	10.985	+2	544	400	230/1/50	837	665	2000	205		916	750	2135	225	1,52						225	1,52	
DOOR H2000	Remoto	MAN DX	GM5P1M	10.825	+2	580	-	230/1/50	837	623	2005	190		916	750	2135	210	1,52						210	1,52	
DOOR H2000	Remoto	MAN SX	GM5P2M	10.825	+2	580	-	230/1/50	837	623	2005	190		916	750	2135	210	1,52						210	1,52	
ENOGALAX MEAT H2400 Monofacciale - Single side																										
DOOR H2000	Motore a bordo	MAN DX	GM6C1M	12.140	+2	580	400	230/1/50	837	623	2357	230		2500	800	1100	270	2,2						270	2,2	
DOOR H2000	Motore a bordo	MAN SX	GM6C2M	12.140	+2	580	400	230/1/50	837	623	2357	230		2500	800	1100	270	2,2						270	2,2	
ENOGALAX MEAT H800 BIfacciale - Double side																										
DOOR H800	Remoto	MAN DX	GB1P1M	9.060	+2	200	-	230/1/50	837	624	883	105		916	750	1010	120	0,76						120	0,76	
DOOR H800	Remoto	MAN SX	GB1P2M	9.060	+2	200	-	230/1/50	837	624	883	105		916	750	1010	120	0,76						120	0,76	
ENOGALAX MEAT H1200 BIfacciale - Double side																										
DOOR H800	Motore a bordo	MAN DX	GB2C1M	9.970	+2	200	330	230/1/50	837	624	1232	155		916	750	1365	170	1						170	1	
DOOR H800	Motore a bordo	MAN SX	GB2C2M	9.970	+2	200	330	230/1/50	837	624	1232	155		916	750	1365	170	1						170	1	
ENOGALAX MEAT H1600 BIfacciale - Double side																										
DOOR H1600	Remoto	MAN DX	GB3P1M	11.065	+2	460	-	230/1/50	837	624	1651	180		916	750	1775	195	1,28						195	1,28	
DOOR H1600	Remoto	MAN SX	GB3P2M	11.065	+2	460	-	230/1/50	837	624	1651	180		916	750	1775	195	1,28						195	1,28	
ENOGALAX MEAT H2000 BIfacciale - Double side																										
DOOR H1600	Motore a bordo	MAN DX	GB4C1M	11.885	+2	460	350	230/1/50	837	624	2000	230		916	750	2135	250	1,52						250	1,52	
DOOR H1600	Motore a bordo	MAN SX	GB4C2M	11.885	+2	460	350	230/1/50	837	624	2000	230		916	750	2135	250	1,52						250	1,52	
DOOR H2000	Remoto	MAN DX	GB5P1M	12.300	+2	580	-	230/1/50	837	624	2005	200		916	750	2135	220	1,52						220	1,52	
DOOR H2000	Remoto	MAN SX	GB5P2M	12.300	+2	580	-	230/1/50	837	624	2005	200		916	750	2135	220	1,52						220	1,52	
ENOGALAX MEAT H2400 BIfacciale - Double side																										
DOOR H2000	Motore a bordo	MAN DX	GB6C1M	13.120	+2	580	420	230/1/50	837	624	2357	250		2500	800	1100	290	2,2						290	2,2	
DOOR H2000	Motore a bordo	MAN SX	GB6C2M	13.120	+2	580	420	230/1/50	837	624	2357	250		2500	800	1100	290	2,2						290	2,2	

OPTIONAL

OPZIONE COLORE LAMINATO SPECIALE - SPECIAL LAMINATED OPTIO-NAL COLOURS - OPTION COLORIS STRATIFIÉ SPÉCIAL H800-H1200	OPT87002	650
OPZIONE COLORE LAMINATO SPECIALE - SPECIAL LAMINATED OPTIO-NAL COLOURS - OPTION COLORIS STRATIFIÉ SPÉCIAL H1600	OPT87003	785
OPZIONE COLORE LAMINATO SPECIALE - SPECIAL LAMINATED OPTIO-NAL COLOURS - OPTION COLORIS STRATIFIÉ SPÉCIAL H2000-H2400	OPT87004	910
RIPIANO SINGOLO CON PIASTRE "QUARZO" - SINGLE SHELF WITH "QUARZO" INSERTS	GA87430011R	380
KIT BARRE COMPLETE FORATE CON OPALINA H800	OPT87010	205
KIT VASCHETTA SCIOGLICONDENSA - CONDENSATE TRAY	OPT87011	325

MIAMI

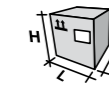
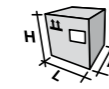

Model	Version	Code	Euro 2022	(TA 30°C - 55% UR)	Capacity (Lt)	Bordeaux (UP TO)	Watt	volt/Ph/ Hz	Width mm	Depth mm	Height mm	Weight kg	(PZ)	Package A Width mm	Package A Depth mm	Package A Height mm	Package A Weight kg	Package A Vol.A mc	Package B (PZ)	Package B Width mm	Package B Depth mm	Package B Height mm	Package B Weight kg	Package B Vol.B mc	Total Pack Weight kg	Total Pack Volume mc
MIAMI B&R VT RF T	VT RF	A1MIAMIBRVTP/*	12.650	+4/+18	84+84		380	230/1/50	1220	500	1970	250	1	1280	550	2200	270	1,55							270	1,55
MIAMI B&R VT RF 12 + 12 DR	VT RF	A1MIAMIBRDVTP/*	14.900	+4/+18	72+72		380	230/1/50	1220	500	1970	250	1	1280	550	2200	270	1,55							270	1,55
MIAMI B&R VT RF T + 3 DR	VT RF	A1MIAMIBRMIXVTP/*	13.610	+4/+18	66+66		380	230/1/50	1220	500	1970	250	1	1280	550	2200	270	1,55							270	1,55
MIAMI B&R VT RF R	VT RF	A1MIAMIBRSHVTP/*	12.905	+4/+18	108+108		380	230/1/50	1220	500	1970	250	1	1280	550	2200	270	1,55							270	1,55
MIAMI VT RF T	VT RF	A1MIAMIVTP/*	6.970	4	126		190	230/1/50	820	500	1970	150	1	880	550	2200	160	1,06							160	1,06
MIAMI VT RF 12 DR	VT RF	A1MIAMIDRVTP/*	8.205	4	96		190	230/1/50	820	500	1970	150	1	880	550	2200	160	1,06							160	1,06
MIAMI VT RF T + 3 DR	VT RF	A1MIAMIMIXVTP/*	7.410	4	96		190	230/1/50	820	500	1970	150	1	880	550	2200	160	1,06							160	1,06
MIAMI VT RF R	VT RF	A1MIAMISHVTP/*	7.075	4	162		190	230/1/50	820	500	1970	150	1	880	550	2200	160	1,06							160	1,06
MIAMI MEDIUM VT RF T	VT RF	A1MIAMIMEDVTP/*	6.530	4	84		190	230/1/50	610	500	1970	130	1	660	550	2200	140	0,80							140	0,80
MIAMI MEDIUM VT RF 12 DR	VT RF	A1MIAMIMEDDRVTP/*	7.590	4	72		190	230/1/50	610	500	1970	130	1	660	550	2200	140	0,80							140	0,80
MIAMI MEDIUM VT RF T + 3 DR	VT RF	A1MIAMIMEDMIXVTP/*	6.770	4	66		190	230/1/50	610	500	1970	130	1	660	550	2200	140	0,80							140	0,80
MIAMI MEDIUM VT RF R	VT RF	A1MIAMIMEDSHVTP/*	6.570	4	108		190	230/1/50	610	500	1970	130	1	660	550	2200	140	0,80							140	0,80
MIAMI MINI VT RF T	VT RF	A1MIAMIMINIVTP/*	5.240	+4/+12	48		150	230/1/50	610	500	1370	50	1	660	550	1520	60	0,55							60	0,55
MIAMI MINI VT RF 6 DR	VT RF	A1MIAMIMINDRVTP/*	5.710	+4/+12	36		150	230/1/50	610	500	1370	50	1	660	550	1520	60	0,55							60	0,55
MIAMI MINI VT RF R	VT RF	A1MIAMIMINISHVTP/*	5.380	+4/+12	60		150	230/1/50	610	500	1370	50	1	660	550	1520	60	0,55							60	0,55

OPTIONAL

Versione predisposta per remotizzazione (senza unità) Prearranged remotable version (without condensing unit)	OPT36001	-250
Luci LED tonalità fredda (5500-6500° K) - Cool white LED lighting (5500-6500° K)	OPT36003	85
Dimmer	OPT36004	135
VALVOLA ALTIMETRICA VETROCAMERA (singola porta) DOUBLE GLAZING PRESSURE EQUALISATION VALVE (single door) (>900 slm)	OPT36005	380

WINEMAX

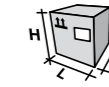
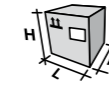
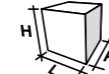

Model	Version	Code	Euro 2022	(TA 30°C - 55% UR)	Ripiani Shelves	Capacity (Lt)	Bordeaux (UP TO)	Watt	volt/Ph/ Hz	Width mm	Depth mm	Height mm	Weight kg	(PZ)	Package A Width mm	Package A Depth mm	Package A Height mm	Package A Weight kg	Package A Vol.A mc	Package B (PZ)	Package B Width mm	Package B Depth mm	Package B Height mm	Package B Weight kg	Package B Vol.B mc	Total Pack Weight kg	Total Pack Volume mc
WINEMAX	UR	Remoto	HRUD1	11.170	+4/+18	560	252	-	230/1/50	671	631	2600	240		2800	800	950	285	2,2						285	2,2	
WINEMAX	VT	Remoto	HRVD1	10.895	+4/+18	560	252	-	230/1/50	671	631	2600	240		2800	800	950	285	2,2						285	2,2	
WINEMAX	UR	Remoto - motore scollegato	HFUD1	11.480	+4/+18	560	252	-	230/1/50	671	631	2600	255		2800	800	950	300	2,2						300	2,2	
WINEMAX	VT	Remoto - motore scollegato	HFVD1	11.205	+4/+18	560	252	-	230/1/50	671	631	2600	255		2800	800	950	300	2,2						300	2,2	
WINEMAX	UR	Motore a bordo	HMUD1	11.320	+4/+18	521	234	500	230/1/50	671	665	2600	255		2800	800	950	300	2,2						300	2,2	
WINEMAX	VT	Motore a bordo	HMVD1	11.055	+4/+18	521	234	500	230/1/50	671	665	2600	255		2800	800	950	300	2,2						300	2,2	

INTERNAL LAYOUT / OPTIONALS

Tubi in acciaio - Steel Tubes - Tubes en acier "T"	GK94330001	180
Tubi in acciaio inclinati - S. Steel Sloping Tubes Tubes en acier inclinés "A"	GK94330002	225
Ripiani in acciaio - Stainless Steel Shelves - Étagères en acier "R"	M294430001	150
Supporti orizz. in Plexiglass - Plexiglass Horiz. Supports - Berceaux horiz. en plexiglas "C"	GK94080001	225
Cassetto estraibile completo di culle - Pull-out drawer with bottle supports - Tiroir coulissant avec clayettes	GK94210001	355
Vaschetta scioglicondensa - Condensate drip tray	OPT87011	350
DIMMER	EL00590158	320
Valvola altimetrica vetrocamera - Double glazing pressure equalisation valve - VANNE ALTIMÉTRIQUE DOUBLE VITRAGE (>900 slm)	OPT36005	380
OPZIONE COLORE LAMINATO SPECIALE - SPECIAL LAMINATED OPTIONAL COLOURS - OPTION COLORIS STRATIFIÉ SPÉCIAL	OPT87004	910

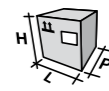
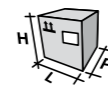
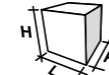

Model	Version	Code	Euro 2022	(TA 30°C - 55% UR)	Ripiani Shelves	Capacity (Lt)	Bordeaux (UP TO)	Watt	volt/Ph/Hz	Package A				Package B					Total Pack Weight kg	Total Pack Volume mc
										Width mm	Depth mm	Height mm	Weight kg	(PZ)	Width mm	Depth mm	Height mm	Weight kg		
iAm STD	H1200	multizona	S1S1N*	3.685	+2/+15; +12/+20 (SET+12)	2	260	130	230/1/50	820	756	1245	115	890	860	1380	130	1,05	130	1,05
iAm STD	H1200	ventilata	S1V1N*	3.895	+2 (SET+2); +16 (SET+16)	2	260	130	230/1/50	820	756	1245	115	890	860	1380	130	1,05	130	1,05
iAm STD	H1600	multizona	M1S1N*	3.895	+2/+15; +12/+20 (SET+12)	3	406	195	230/1/50	820	756	1625	125	890	860	1760	140	1,07	140	1,07
iAm STD	H1600	ventilata	M1V1N*	4.110	+2 (SET+2); +16 (SET+16)	3	406	195	230/1/50	820	756	1625	125	890	860	1760	140	1,07	140	1,07
iAm STD	H2000	multizona	L1S1N*	4.585	+2/+15; +12/+20 (SET+12)	4	536	260	230/1/50	820	756	1966	135	890	860	2100	150	1,67	150	1,67
iAm STD	H2000	ventilata	L1V1N*	4.255	+2 (SET+2); +16 (SET+16)	4	536	260	230/1/50	820	756	1966	135	890	860	2100	150	1,67	150	1,67
iAm STD	H2000	ventilata tropicalizzata	L1W1N*	4.585	+2 (SET+2); +16 (SET+16)	4	536	260	230/1/50	820	756	1966	135	890	860	2100	150	1,67	150	1,67
iAm STD DUALVENT	H2000	DualVent ventilata	L2V1N*	5.175	+4+18*(B)	4	536	260	230/1/50	820	756	1966	135	890	860	2100	150	1,67	150	1,67
iAm FIT	H2000	multizona	B1S1N*	3.915	+2/+15; +12/+20 (SET+12)	4	355	144	230/1/50	820	556	1966	120	890	660	2100	135	1,28	135	1,28
iAm FIT	H2000	ventilata	B1V1N*	4.125	+2 (SET+2); +16 (SET+16)	4	355	144	230/1/50	820	556	1966	120	890	660	2100	135	1,28	135	1,28
iAm FIT	H2000	ventilata tropicalizzata	B1W1N*	4.450	+2 (SET+2); +16 (SET+16)	4	355	144	230/1/50	820	556	1966	120	890	660	2100	135	1,28	135	1,28
iAm FIT DUALVENT	H2000	DualVent ventilata	B2V1N*	5.080	+4+18*(B)	4	355	144	230/1/50	820	556	1966	120	890	660	2100	135	1,28	135	1,28
iAm FIT SLIM	H1600	multizona	N1S1N	3.800	+2/+18		180	72	130 230/1/50	600	556	1626	60	670	660	1750	70	0,8	70	0,8
iAm FIT SLIM	H1600	ventilata	N1V1N	3.960	+2/+18		180	72	140 230/1/50	600	556	1626	60	670	660	1750	70	0,8	70	0,8
iAm FIT SLIM	H1600	ventilata tropicalizzata	N1W1N	4.180	+2/+18		180	72	230 230/1/50	600	556	1626	60	670	660	1750	70	0,8	70	0,8
iAm FIT SLIM	H2000	multizona	F1S1N	3.865	+2/+18		240	96	130 230/1/50	600	556	1966	95	670	660	2100	105	1	105	1
iAm FIT SLIM	H2000	ventilata	F1V1N	4.045	+2/+18		240	96	140 230/1/50	600	556	1966	95	670	660	2100	105	1	105	1
iAm FIT SLIM	H2000	ventilata tropicalizzata	F1W1N	4.310	+2/+18		240	96	230 230/1/50	600	556	1966	95	670	660	2100	105	1	105	1
iAm FIT SLIM DOPPIA	H2000	multizona	H1S1N	7.470	+2/+18		480	192	260 230/1/50	1200	598	1966	190	1290	660	2100	205	1,8	205	1,8
iAm FIT SLIM DOPPIA	H2000	ventilata	H1V1N	7.740	+2/+18		480	192	280 230/1/50	1200	598	1966	190	1290	660	2100	205	1,8	205	1,8
iAm FIT SLIM DOPPIA	H2000	ventilata tropicalizzata	H1W1N	8.480	+2/+18		480	192	460 230/1/50	1200	598	1966	190	1290	660	2100	205	1,8	205	1,8

OPTIONAL

Ripiano fisso (portabottiglie) - Fixed shelf (bottle holder) i.Am STD	GA89430001	60
Ripiano fisso (portabottiglie) - Fixed shelf (bottle holder) i.Am FIT	GA89430002	55
Ripiano fisso (portabottiglie) - Fixed shelf (bottle holder) i.Am FIT SLIM	GA89430007	55
Cassetto estraibile - Removable drawers lying bottles i.Am STD	GA8921*001	200
Cassetto estraibile - Removable drawers lying bottles i.Am FIT	GA8921*019	165
Cassetto estraibile - Removable drawers lying bottles i.Am FIT SLIM	GA8921*026	165
Cassetto estraibile bottiglie verticali i.Am STD	GA8921*014	580
Kit tubi neri bottiglie inclinate 16° - Kit black tubes inclined bottles i.Am STD	GA89330002	180
Kit tubi neri bottiglie inclinate 16° - Kit black tubes inclined bottles i.Am FIT	GA89330001	135
Kit tubi neri bottiglie inclinate 16° - Kit black tubes inclined bottles i.Am FIT SLIM	GA89330003	135
*Supporto modulare porta cassette/ripianti - Modular support for drawers - shelves i.Am h2000	M28909N003	45
*Supporto modulare porta cassette/ripianti - Modular support for drawers - shelves i.Am h1600	M28909N005	45
*Supporto modulare porta cassette/ripianti - Modular support for drawers - shelves i.Am h1200	M28909N006	40
*Supporto modulare porta cassette/ripianti - Modular support for drawers - shelves i.Am h2000 DUALVENT	M28909N014	40
Kit illuminazione led luce calda verticale - Lighting kit led warm light vertical i.Am h2000	GE89590010	280
Kit illuminazione led luce calda verticale - Lighting kit led warm light vertical i.Am h1600	GE89590011	255
Kit illuminazione led luce calda verticale - Lighting kit led warm light vertical i.Am h1200	GE89590012	210
Kit illuminazione led luce calda verticale - Lighting kit led warm light vertical i.Am h2000 DUALVENT	GE89590015	435
Dimmer controllo led iam con telecomando - Led control dimmer with remote control	EL89590004	105
Valvola almetrica vetrocamera - Double glazing pressure equalisation valve - VANNE ALTIMÉTRIQUE DOUBLE VITRAGE (>900 slm)	OPT36005	380

i.Am Conservatore

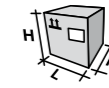
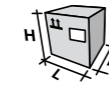
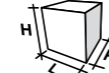

Model	Version		Code	Euro 2022	(TA 30°C - 55% UR)	Ripiani Shelves	Capacity (Lt)	Bordeaux (UP TO)	Watt	volt/Ph/Hz	Package A				Package B					Total Pack Weight	Total Pack Volume						
											Width	Depth	Height	Weight	(PZ)	Width	Depth	Height	Weight			Vol.A	(PZ)	Width	Depth	Height	Weight
											mm	mm	mm	kg		mm	mm	mm	kg	mc	mm	mm	mm	kg	mc	kg	mc
iAm CONSERVATORE	H2000	D Bordeaux	U1N1D	8.185	+12/+18		545	165	200	230/1/50	820	756	1966	170	890	860	2100	185	1,62							185	1,62
iAm CONSERVATORE	H2000	L Bourgogne	U1N1L	7.695	+12/+18		545	_(120)	200	230/1/50	820	756	1966	170	890	860	2100	185	1,62							185	1,62
iAm CONSERVATORE	H2000	MIX	U1N1M	7.935	+12/+18		545	_81+(60)	200	230/1/50	820	756	1966	170	890	860	2100	185	1,62							185	1,62
iAm CONSERVATORE FIT	H2000	D Bordeaux	R1N1D	7.230	+12/+18		350	82	200	230/1/50	820	556	1966	155	890	660	2100	170	1,25							170	1,25
iAm CONSERVATORE FIT	H2000	L Bourgogne	R1N1L	6.955	+12/+18		350	_(60)	200	230/1/50	820	556	1966	155	890	660	2100	170	1,25							170	1,25
iAm CONSERVATORE FIT	H2000	MIX	R1N1M	7.115	+12/+18		350	_40+(30)	200	230/1/50	820	556	1966	155	890	660	2100	170	1,25							170	1,25
iAm CONSERVATORE FIT SLIM	H2000	D Bordeaux	P1N1DN	6.890	+12/+18		240	58	200	230/1/50	600	556	1966	125	670	660	2100	135	1							135	1
iAm CONSERVATORE FIT SLIM	H2000	L Bourgogne	P1N1LN	6.935	+12/+18		240	_(40)	200	230/1/50	600	556	1966	125	670	660	2100	135	1							135	1
iAm CONSERVATORE FIT SLIM	H2000	MIX	P1N1MN	6.935	+12/+18		240	_28+(20)	200	230/1/50	600	556	1966	125	670	660	2100	135	1							135	1
iAm CONSERVATORE FIT SLIM	H1600	D Bordeaux	T1N1DN	6.850	+12/+18		180	43	200	230/1/50	600	556	1626	80	670	660	1750	90	0,8							90	0,8
iAm CONSERVATORE FIT SLIM	H1600	L Bourgogne	T1N1LN	6.850	+12/+18		180	_(28)	200	230/1/50	600	556	1626	80	670	660	1750	90	0,8							90	0,8
iAm CONSERVATORE FIT SLIM	H1600	MIX	T1N1MN	6.850	+12/+18		180	_18+(16)	200	230/1/50	600	556	1626	80	670	660	1750	90	0,8							90	0,8

* i supporti sono necessari per l'installazione del singolo cassetto - Supports are needed to install single drawers -
Les supports sont nécessaires pour l'installation de chaque tiroir

CONDIZIONI GENERALI DI VENDITA

- Disposizioni generali
- Le presenti Condizioni Generali sono state predisposte per essere applicate ai contratti di vendita di Enofrigo S.p.A, salvo eventuali deroghe concordate per iscritto dai contraenti.
- Eventuali deroghe o condizioni aggiuntive saranno valide solo se pattuite per iscritto.
- Qualsiasi riferimento a termini di resa si intende fatto al rispettivo termine degli Incoterms® vigenti pubblicati dalla Camera di Commercio Internazionale. In conformità alle disposizioni in materia di protezione dei dati personali, Enofrigo S.p.A informa l'Acquirente che i dati personali raccolti saranno custoditi ed utilizzati ai soli fini dei contratti stipulati, degli impegni connessi e della conclusione di affari futuri.
- Ordini
- Gli ordini raccolti da agenti e/o ausiliari del Venditore o comunque pervenuti allo stesso non sono vincolanti per il Venditore sino a che non vengano da questo integralmente o parzialmente accettati.
- Linvio dell'ordine da parte dell'Acquirente impegna l'Acquirente stesso ai prezzi ed alle condizioni del nostro listino di vendita in vigore alla data di consegna prevista dalla nostra conferma d'ordine.
- Qualsiasi condizione espressa da funzionari od intermediari della nostra società sarà senza valore se non riprodotta nel testo del nostro fax o e-mail di conferma.
- L'ordine dell'Acquirente si intende perfezionato ed il contratto concluso ad ogni effetto all'atto della nostra conferma d'ordine scritta.
- Il testo della nostra conferma d'ordine ha prevalenza, comunque ed in ogni sua parte, sui termini indicati dall'Acquirente nel Suo ordine.
- Se entro 2 (due) giorni lavorativi dalla data di ricezione della nostra conferma l'Acquirente non avrà provveduto a notificare un Suo diverso avviso, l'Acquirente Stesso si intende tacitamente obbligato.
- In ogni caso, comunque, l'Acquirente autorizza la consegna anche senza previa risposta, dispensando il Venditore dall'onere di comunicargli l'iniziativa esecuzione del contratto ed esonerandolo da qualsivoglia risarcimento del danno.
- Il Venditore si riserva il diritto di sospendere e/o annullare integralmente o parzialmente l'esecuzione di ordini già accettati quando l'esecuzione sia resa impossibile o irragionevolmente onerosa da un impedimento imprevedibile indipendente dalla sua volontà, quale ad esempio sciopero, incendio, guerra, sommosse e rivoluzioni, interruzioni di energia, terremoti, alluvioni, ritardi dei suoi fornitori nella consegna di materie prime, componenti finiti o semifiniti.
- Caratteristiche dei Prodotti
- Eventuali informazioni o dati sulle caratteristiche e/o specifiche tecniche dei Prodotti, contenute in depliant, listini prezzi, cataloghi o documenti simili saranno vincolanti solo nella misura in cui tali dati siano stati espressamente richiamati nel contratto.
- Il Venditore si riserva di apportare ai Prodotti le modifiche che, senza alterare le caratteristiche essenziali dei Prodotti, dovessero risultare necessarie od opportune.
- Termini di Consegna
- Eventuali date di consegna indicate dal Venditore verranno considerate unicamente indicative, a meno che il Venditore non si impegni specificamente per iscritto.
- Inoltrando un ordine l'Acquirente accetta che i tempi di consegna non siano un elemento essenziale e rinuncia a qualunque richiesta di risarcimento per ritardi nella consegna o di annullamento dell'ordine.
- Resa e Spedizione – Reclami
- Salvo patto contrario la vendita si intende effettuata FCA-FREE CARRIER (Incoterms® vigenti), Via dell'Industria 9A, 35010 Borgoricco, Padova, Italia e ciò avviene anche quando sia convenuto che la spedizione o parte di essa venga curata dal Venditore.
- A meno che il venditore non accetti espressamente condizioni diverse per iscritto (i) il rischio di perdita o danno ai Prodotti verrà trasferito all'Acquirente nel momento in cui il Venditore consegna ad un vettore i Prodotti adeguatamente imballati per il trasporto, (ii) il Venditore non sarà tenuto a stipulare un'assicurazione che copra i Prodotti spediti, (iii) eventuali disposizioni adottate dal Venditore, su richiesta dell'Acquirente con i vettori o gli spedizionieri in merito alla spedizione verranno attuate esclusivamente per conto dell'Acquirente, esclusivamente a spese e a rischio di quest'ultimo, inoltre (iv) un eventuale spedizioniere incaricato di tale spedizione sarà considerato l'unico incaricato dell'Acquirente a tutti gli effetti.
- Eventuali reclami relativi allo stato dell'imballo, quantità, numero o caratteristiche esteriori dei Prodotti, dovranno a pena di decadenza essere contestati immediatamente al vettore nel documento di trasporto e notificati poi tempestivamente al Venditore mediante lettera raccomandata R.R. sempre a pena di decadenza, entro sette giorni dalla data di ricevimento dei Prodotti. Eventuali reclami relativi a difetti non individuabili mediante un diligente controllo al momento del ricevimento (vizi occulti) dovranno essere notificati al Venditore mediante lettera R.R. a pena di decadenza, entro sette giorni dalla data della scoperta del difetto e comunque non oltre dodici mesi dalla consegna.
- E' inteso che eventuali reclami o contestazioni non daranno diritto all'Acquirente di sospendere o comunque ritardare i pagamenti dei Prodotti oggetto di contestazione, né, tanto meno, di altre forniture.
- Prezzi e condizioni di pagamento
- Salvo patto contrario i prezzi si intendono per Prodotti non imballati, FCA-FREE CARRIER – BORGORICCO, essendo inteso che qualsiasi altra spesa od onere sarà a carico dell'Acquirente.
- Salvo diverso accordo si applicherà il prezzo di listino del Venditore – IVA esclusa – in vigore dalla data di conclusione del contratto ed il pagamento sarà esigibile al ricevimento della fattura del Venditore.
- Il pagamento dovrà essere effettuato conformemente alle condizioni riportate in conferma d'ordine e/o in fattura.
- In caso di ritardo nel pagamento, il Venditore avrà la facoltà di sospendere le consegne e potrà, a sua discrezione, risolvere il contratto.
- L'Acquirente sarà poi tenuto a corrispondere al Venditore gli interessi di mora a partire dal momento in cui il pagamento sarebbe dovuto avvenire indipendentemente dalla messa in mora, nella misura indicata ai sensi e per gli effetti dell'Art. 1284 Codice Civile Italiano.
- Riserva di proprietà
- I Prodotti forniti resteranno di proprietà del Venditore fino a quando non sia pervenuto a quest'ultimo il completo pagamento.
- L'Acquirente è tenuto a collaborare con il Venditore nelle misure che questi intenda adottare per proteggere il suo diritto sui Prodotti forniti. Se e quando terzi intendano stabilire o affermare un diritto sui Prodotti in questione, l'Acquirente dovrà comunicarlo tempestivamente al Venditore pena il risarcimento dei danni che quest'ultimo da detto inadempimento avesse a subire dal medesimo o dalla clientela di quest'ultimo.
- Garanzia per Vizi
- Il Venditore si impegna a porre rimedio a qualsiasi vizio, mancanza di qualità o difetto di conformità dei Prodotti a lui imputabile, verificatosi entro dodici mesi dalla consegna dei Prodotti, purché gli stessi gli siano stati notificati tempestivamente in conformità all'art. 5.3 e la loro esistenza sia stata accertata dal medesimo Venditore. Le spese di trasporto dei Prodotti che l'Acquirente denuncia essere viziati o difettare di qualità o conformità saranno a carico dell'Acquirente. Restano esclusi dalla garanzia le parti elettriche ed elettroniche e quei componenti dei Prodotti che per natura o destinazione sono soggetti a deterioramento o logorio.
- Salvo il caso di dolo o colpa grave, il Venditore, in caso di vizi, mancanza di qualità o difetto di conformità dei Prodotti, potrà scegliere se riparare o sostituire i Prodotti o rimborsare il prezzo pagato dei Prodotti difettosi. E' inteso che la suddetta garanzia è assorbente e sostitutiva delle garanzie o responsabilità previste per legge, ed esclude ogni altra responsabilità del Venditore comunque originata dai Prodotti forniti (ad es. risarcimento del danno, mancato guadagno, campagne di ritiro, etc.). I Prodotti sostituiti o riparati in garanzia saranno soggetti alla medesima garanzia di dodici mesi dalla data della sostituzione o riparazione.
- Nessun Prodotto potrà essere restituito dall'Acquirente senza una preliminare autorizzazione scritta del Venditore.
- Il Venditore non garantisce la rispondenza dei Prodotti a particolari specifiche o caratteristiche tecniche o la loro idoneità ad usi e/o utilizzazioni particolari se non nella misura in cui tali caratteristiche siano state espressamente convenute nel contratto.
- Il Venditore non sarà ritenuto responsabile per danni che l'Acquirente, o terzi aventi causa da quest'ultimo, vantino di aver subito dall'utilizzazione dei Prodotti qualora sia accertato che i danni non dipendano dalla qualità o caratteristiche intrinseche del Prodotto ma dalla scelta di utilizzazione effettuata dall'Acquirente.
- L'Acquirente decadrà dalla garanzia se utilizzerà i Prodotti in modo non conforme alle istruzioni del Venditore; l'Acquirente decadrà altresì dalla garanzia se provvederà autonomamente, e così senza l'autorizzazione e/o il controllo del Venditore a smontare, modificare, tentare di riparare i Prodotti.
- Legge applicabile e Foro competente
- Qualsiasi questione riguardante il presente contratto che non sia espressamente o implicitamente risolta dalle presenti condizioni generali o da eventuali condizioni specifiche convenute tra i contraenti è disciplinata dalla Convenzione delle Nazioni Unite sulla Vendita Internazionale di Merci (Convenzione di Vienna del 1980) e per le questioni non coperte da tale convenzione dalla legge italiana.
- Qualsiasi controversia derivante dal presente contratto o collegata allo stesso, o in relazione ai Prodotti sarà sottoposta in via esclusiva al giudizio del Tribunale di Padova; tuttavia in deroga a quanto stabilito sopra, il Venditore ha sempre la facoltà di portare la controversia davanti al Giudice competente presso la sede dell'Acquirente.
- Clausole Finali

L'eventuale invalidità parziale o totale di una clausola delle presenti condizioni generali di vendita non comporterà l'invalidità rispettivamente dell'intera clausola ovvero delle stesse Condizioni Generali di Vendita.

CONDIZIONI DI VENDITA

I.V.A.	Esclusa, comunque a norma di legge
IMBALLO	Cartone rinforzato (compreso) Cassa/gabbia (su richiesta - con supplemento)
RESA	FCA-FREE CARRIER, Borgoricco (PD) ITALY
CONSEGNA	Da concordare all'ordine
PAGAMENTO	Come accordato
CONDIZIONI GENERALI	Come riportato sul retro della fattura

GENERAL CONDITIONS OF SALE

- General provisions
- These General Sales terms and Conditions have been drawn up in order to be applied to Enofrigo S.p.A's Sales Agreements, excepting any eventual exceptions agreed upon in writing by the contracting parties hereto.
- Any eventual exceptions or additional conditions shall only be held to be valid if agreed in writing.
- Any reference to the delivery terms is taken in accordance with the terms contained in Incoterms®, published by the International Chamber of Commerce.
- In accordance with the protection of the personal data dispositions, Enofrigo S.p.A. informs the Purchaser that the collected personal data will be kept and used only for signed contracts, the related agreements and the cessation of future business.
- Orders
- Orders gathered by the Seller's agents and/or employees or which in any way arrive at the attention of the former, shall not be held to be binding upon the Seller until the same are not fully or partially accepted.
- The order sent by the Purchaser will be subject to the prices and the conditions of our price list as of the delivery date specified in our order confirmation.
- Any condition communicated by the staff or negotiators of our Company will not be valid if not reproduced in the text of the order confirmation sent by e-mail or fax.
- The Purchaser's order is considered accepted and the contract signed with our written order confirmation.
- The text of our order confirmation prevails in any case and in each part over the terms indicated by the Purchaser on his order.
- If within two working days from receipt of our order confirmation the Purchaser will not arrange to notify a different communication, the Purchaser himself is considered tacitly obliged.
- Nevertheless, the Purchaser authorizes the delivery even without answer, dispensing the Seller from the obligation of notifying the start of the contract's execution and from any damage compensation.
- The Seller is entitled to suspend and/or cancel, either fully or partially, the processing of the orders, already accepted, when their processing is rendered impossible or made too burdensome by unforeseeable problems and independent of his will, such as, for example, strikes, fires, wars, insurgences and revolutions, interruptions to the energy supply, earthquakes, floods and delays made by his supplier in delivering the raw materials, finished or unfinished components.
- The Products Characteristics
- Any information or data on the Products' characteristics and/or technical specifications, contained in brochures, price lists, catalogues or similar documents shall only be held to be binding in the measure in which said information has been explicitly quoted in the contract.
- The Seller is entitled to amend the Products, without the latter changing the essential characteristics inherent in the Products, but which might be retained to be necessary or opportune.
- Delivery Terms
- Any delivery information supplied by the Seller shall merely be considered to be indicative, unless the Seller undertakes to put the same in writing.
- When a Purchaser sends an order, he accepts that the delivery times are not an essential element and renounces to any request for compensation due to delays in delivery or cancellation of the order.
- Delivery and Consignment – Complaints
- Unless agreed otherwise, the sale is understood to be made, FCA-FREE CARRIER (Incoterms® in force), Via dell'Industria 9A, 35010 Borgoricco, Padova, Italy, and this occurs even when it has been agreed that the consignment or a part of the same is dealt with by the Seller.
- Unless the Seller explicitly accepts different conditions in writing (i) the risk of loss or damage to the Products shall be transferred to the Purchaser when the Seller delivers the Products to the carrier, suitably packaged for transportation, (ii) the Seller shall not be bound to provide insurance cover for the Products sent, (iii) any provisions adopted by the Seller, on the Purchaser's request, with carriers or shipping agents, with reference to the consignment, shall be exclusively carried out on behalf of the Purchaser and exclusively at the expense and risk of the latter; moreover (iv) the shipping agent appointed for said consignment shall be considered to be the sole party appointed by the Purchaser, to all effects.
- Any complaints relative to the Products' state of packaging, quantity, number or exterior characteristics, must be brought immediately to the attention of the carrier in the pertinent transportation documentation and then sent in good time to the Seller by registered mail, in order to avoid forfeiting his rights in merit, within seven days from receipt of the Products. Any complaints relative to defects that cannot be detected after careful checking, when the Products are received (latent defects), must in any case be brought to the attention of the Seller by means of registered mail, at the risk of forfeiting his rights in merit, within seven days from discovery of the defect and, in any case, no later than twelve months after delivery.
- It is understood that any complaints or disputes shall not entitle the Purchaser from suspending or, in any case, delaying payment of the Products, subject to dispute, nor payment of other supplies.
- Prices and payment conditions
- Excepting where agreed otherwise, the prices are understood to be for unpackaged Products, FCA-FREE CARRIER-BORGORICCO, it being understood that any further expenses or charges shall be attributed to the Purchaser.
- Excepting where agreed otherwise, the Seller's list price shall be applied, less VAT, which is in force on the date on which the Agreement is executed and payment shall be required on receipt of the Seller's invoice.
- Payment must be made in compliance with the conditions contained in the order confirmation and/or invoice.
- Should there be any delay in payment, the Seller shall be entitled to suspend deliveries and may, at his own discretion, terminate the agreement.
- The Purchaser shall pay interest to the Seller starting from the time when the payment should have been made, irrespective of the warning notice, at the rate and according to the methods established in Article 1284 of the Italian Civil Code.
- Retention of title
- The Products supplied shall remain as the Seller's property until the latter has received full payment thereof.
- The Purchaser is obliged to assist the Seller in those measures that the latter wishes to adopt in order to protect his rights over the Products supplied. If and when third parties intend establishing or confirming a right over the Products, in case of point, the Purchaser must immediately inform the Seller, or be obliged to compensate the damage sustained by the latter in favour of the third parties or by the latter's clientele due to said non compliance.
- Warranty for defects
- The Seller undertakes to remedy any defect, lack of quality or conformity found in the Products, which might be attributable to himself, that arises within twelve months from the Products' delivery, as long as the same have been communicated in good time, in compliance with Art. 5.3 and their existence has been ascertained by the Seller himself. The transportation costs incurred by the Products that the Purchaser has declared as being defective or lacking in quality or conformity shall be charged to the Purchaser. Electrical and electronic parts and those parts of the Products that are subject, due to their nature and use, to wear and tear or deterioration shall not be included in the warranty.
- Excepting cases of misrepresentation or gross negligence, the Seller, in the case of faults, lack of quality or conformity found in the Products, may choose to repair or replace the Products or reimburse the price paid for the faulty Products. It is understood that said warranty absorbs and replaces the guarantees or liabilities foreseen by law, and excludes any other liability attributable to the Seller that might arise out of the Products supplied (for example, compensation of damages, loss of earnings, recall campaigns, etc.). The Products that are replaced or repaired under warranty shall be covered by the same twelve-month warranty from the date of their replacement or repair.
- No Product whatsoever may be returned by the Purchaser unless he has received the Seller's written authorization to do so.
- The Seller does not guarantee the Products' meeting particular specifications or technical characteristics or their suitability for use and/or particular use, except for in the measure that said characteristics have been explicitly agreed upon in the Agreement.
- The Seller shall not be held liable for damages that the Purchaser, or third parties claiming against the latter, claim to have sustained from using the Products, should it be ascertained that the damages is not dependent on the Product's quality or intrinsic characteristics, but due to the use they have been put to by the Purchaser.
- The Purchaser shall forfeit the warranty if the Products are used in a way that is not in compliance with the instructions laid down by the Seller; the Purchaser shall also forfeit the warranty if he, on his own initiative, without the Seller's authorisation and/or control in merit, disassembles, amends or tries to repair the Products.
- Applicable law and competent court
- Any matter regarding this Agreement which has not been explicitly or implicitly resolved by these General Conditions of Sale or by any specific conditions agreed upon by the contracting parties shall be governed by the United Nations Convention on the International Sale of Goods (The Vienna Convention, 1980) and for any matters not covered by said convention, by Italian Law.
- Any dispute arising out of this Agreement or connected to the same or in any way related to the Products, shall be exclusively submitted to the Court of Padova; however, in exception of that which has been established foregoing hereto, the Seller is always entitled to have the dispute submitted to the competent Judge, where the Purchaser is resident.
- Final Clauses

Any eventual partial or total invalidity of a clause contained in these General Conditions of Sale shall not lead to the invalidity of the entire clause or the General Conditions of Sale themselves.

TERMS OF SALES

V.A.T.	Excluded
PACKAGING	Carton on pallet (included) Sealed Crate and cage (on request - with charge)
DELIVERY	FCA-FREE CARRIER, Borgoricco (PD) ITALY INCOTERM ®2010
DELIVERY TIME	To be agreed upon
PAYMENT	As per agreement
GENERAL TERMS	As stated on back of invoice

CONDITIONS GÉNÉRALES DE VENTE

1. Dispositions générales
- 11 Les présentes conditions générales ont été rédigées pour être appliquées aux contrats de vente d'Enofrigro S.p.A, sans préjudice d'éventuelles dérogations établies par écrit par les contractants
- 12 D'éventuels dérogations ou avenants aux présentes conditions ne seront valables que s'ils font l'objet d'un accord écrit
- 13 Toute référence à des délais de livraison sera interprétée selon les conditions des Incoterms® en vigueur publiés par la Chambre de Commerce internationale.
- 14 En vertu des dispositions en matière de protection des données à caractère personnel, Enofrigro S.p.A informe l'Acheteur que les données personnelles collectées seront gardées et utilisées aux seules fins des contrats stipulés, des engagements connexes et de la conclusion d'affaires futures.
2. Commandes
- 21 Les commandes prises par des agents et/ou auxiliaires du Vendeur ou celles qui, dans tous les cas, lui seraient parvenues, ne sont pas contraignantes pour le Vendeur tant que ce dernier ne les a pas intégralement ou partiellement acceptées.
- 22 L'envoi de la commande de la part de l'Acheteur engage ce même Acheteur vis-à-vis des prix et des conditions de notre catalogue en vigueur à la date de livraison prévue par notre confirmation de commande
- 23 Toute condition expresse de la part de délégués ou d'intermédiaires de notre société restera sans aucune valeur si elle n'est pas retranscrite dans le texte de notre fax ou de notre e-mail de confirmation.
- 24 La commande de l'Acheteur est considérée comme finalisée et le contrat conclu de plein droit lors de notre confirmation de commande écrite.
- 25 Dans tous les cas, le texte de notre confirmation de commande prévaut en tout point contre les termes indiqués par l'Acheteur dans sa commande.
- 26 Si dans les 2 (deux) jours ouvrables suivant la réception de notre confirmation, l'Acheteur n'a pas notifié d'avis contraire, ce même Acheteur est considéré comme tacitement obligé.
- 27 Quoi qu'il en soit, dans tous les cas l'Acheteur autorise la livraison, même sans réponse préalable ; il dispense par la même le Vendeur de lui communiquer le début de l'exécution du contrat et l'exempte de toute réparation de préjudice.
- 28 Le Vendeur se réserve le droit de suspendre et/ou d'annuler intégralement ou partiellement l'exécution des commandes déjà acceptées dans le cas où cette exécution de commande s'avérerait impossible ou déraisonnablement onéreuse en raison d'un empêchement indépendant de sa volonté, comme par exemple en cas de grève, incendie, guerre, émeutes et révolutions, coupures d'énergie, tremblements de terre, inondations, retard des fournisseurs dans la livraison des matières premières, de produits finis ou semi-finis.
3. Caractéristiques des produits
- 31 D'éventuelles informations ou données sur les caractéristiques et/ou spécifications techniques des produits, mentionnées dans les dépliants, bordereaux de prix, catalogues ou documents similaires seront contraignants uniquement s'il est fait expressément mention de ces données dans le contrat.
- 32 Le Vendeur se réserve d'apporter aux produits des modifications s'avérant nécessaires ou opportunes, sans que celles-ci n'altèrent les caractéristiques essentielles des produits.
4. Délais de livraison
- 41 D'éventuelles dates de livraison indiquées par le Vendeur ne seront considérées qu'à titre indicatif, à moins que le Vendeur ne s'engage de façon spécifique par écrit.
- 42 En passant commande, l'Acheteur accepte que les délais de livraison ne constituent pas un élément essentiel et il renonce à toute demande d'indemnisation pour des retards de livraison ou à toute annulation de commande.
5. Livraison et expédition - Réclamations
- 51 Sauf convention contraire, la vente s'entend rendue FCA-FREE CARRIER (Incoterms® en vigueur), Via dell'Industria 9A, 35010 Borgoricco, Padoue, Italie et ce, également lorsque tout ou partie de l'expédition sera organisée par le Vendeur.
- 52 À moins que le Vendeur n'accepte expressément des conditions différentes par écrit (i) le risque de perte ou de dommage aux produits sera transféré à l'Acheteur au moment où le Vendeur remettra à un transporteur les produits correctement emballés pour le transport, (ii) le Vendeur ne sera pas tenu de stipuler une assurance qui couvre les produits expédiés, (iii) d'éventuelles dispositions adoptées par le Vendeur, à la demande de l'Acheteur, avec les transporteurs ou les transitaires en ce qui concerne l'expédition, seront mises en œuvre exclusivement pour le compte de l'Acheteur et exclusivement aux frais et aux risques de ce dernier (iv) un éventuel transitaire chargé de l'expédition sera considéré comme le seul mandataire de l'Acheteur, à tous les effets.
- 53 Sous peine de déchéance, d'éventuelles réclamations concernant l'état de l'emballage, les quantités, le nombre ou les caractéristiques extérieures des produits devront être immédiatement contestées au transporteur puis notifiées sans délai au Vendeur par lettre recommandée AR, toujours sous peine de déchéance, dans un délai de sept jours à partir de la date de réception des produits. D'éventuelles réclamations concernant des défauts non identifiables lors d'un contrôle diligent au moment de la réception (vices cachés) devront être notifiées au Vendeur par lettre recommandée AR, sous peine de déchéance, dans un délai de sept jours à partir de la date à laquelle le défaut a été découvert et dans tous les cas, pas plus de douze mois après la date de livraison.
- 54 Il est entendu que d'éventuelles réclamations ou contestations ne donneront pas droit à l'Acheteur de suspendre ou de retarder les paiements des produits faisant l'objet de la contestation, ni, à plus forte raison, ceux d'autres fournitures.
6. Prix et conditions de paiement
- 61 Sauf convention contraire, les prix s'entendent pour des produits non emballés, FCA-FREE CARRIER – BORGORICCO, étant entendu que toute autre dépense ou charge sera aux frais de l'Acheteur.
- 62 Sauf accord contraire, on appliquera le prix catalogue du Vendeur – HT. – en vigueur à la date de conclusion du contrat et le paiement sera exigible à réception de la facture du Vendeur.
- 63 Le paiement devra être effectué conformément aux conditions reportées dans la confirmation de commande et/ou sur la facture.
- 64 En cas de retard de paiement, le Vendeur aura la faculté de suspendre les livraisons et pourra, à son entière discrétion, résilier le contrat.
- 65 L'Acheteur sera ensuite tenu de payer au Vendeur des intérêts moratoires à compter du moment où le paiement aurait dû être effectué indépendamment de la mise en demeure, dans la mesure indiquée en vertu et aux fins de l'article 1284 du Code Civil Italien.
7. Réserve de propriété
- 71 Les produits fournis resteront la propriété du Vendeur tant que ce dernier n'aura pas encaissé l'intégralité du paiement.
- 72 L'Acheteur est tenu de collaborer avec le Vendeur en fonction des mesures qu'il entend prendre pour protéger son droit sur les produits finis. Si et quand des tiers entendent établir ou affirmer un droit sur les produits en question, l'Acheteur devra le communiquer sans délai au Vendeur sous peine de réparer le préjudice que ce dernier aurait à subir, par l'Acheteur même ou par la clientèle de l'Acheteur.
8. Garantie contre les vices
- 81 Le Vendeur s'engage à remédier à quelque vice que ce soit, manque de qualité ou défaut de conformité des produits, qui lui est imputable et qui s'est vérifié dans les douze mois suivant la livraison des produits, à condition qu'il ait été notifié sans délai, conformément à l'art. 53 et que ce même Vendeur ait pu constater son existence. Les frais de transport concernant les produits que l'Acheteur dit être défectueux ou auxquels il est reproché un manque de qualité ou un défaut de conformité seront à la charge de l'Acheteur. Restent exclues de la garantie les parties électriques et électroniques ainsi que les composants des produits qui, par leur nature ou leur fonction, sont susceptibles d'être détériorés ou usés.
- 82 Sauf en cas de dol ou de faute grave, le Vendeur pourra choisir, en cas de vices, manque de qualité ou défaut de conformité, de réparer ou de remplacer les produits ou bien de rembourser le montant payé pour les produits défectueux. Il est entendu que la garantie sus citée englobe et remplace toutes les garanties ou responsabilités prévues par la loi et qu'elle exclut toute autre responsabilité du Vendeur découlant des produits fournis (par exemple: dommages-intérêts, manque-à-gagner, campagnes de rappel, etc.). Les produits remplacés ou réparés en garantie feront l'objet de la même garantie de douze mois à partir de la date de remplacement ou de réparation.
- 83 Aucun produit ne pourra être restitué par l'Acheteur sans autorisation préalable du Vendeur.
- 84 Le Vendeur ne garantit la conformité des produits à des spécifications ou caractéristiques techniques particulières, ainsi que leur adéquation à des usages et/ou utilisations particuliers que dans la mesure où de telles caractéristiques ont été expressément convenues dans le contrat.
- 85 Le Vendeur ne sera pas tenu responsable pour des dommages que l'Acheteur ou des tiers - ses ayants droit - déclareraient avoir subis en utilisant les produits s'il est vérifié que ces dommages ne résultent pas de la qualité ou des caractéristiques intrinsèques du produit mais du choix d'utilisation effectué par l'Acheteur.
- 86 L'Acheteur sera déchu de la garantie s'il utilise les produits de façon non conforme aux instructions du Vendeur. L'Acheteur sera également déchu de la garantie s'il démonte, modifie ou tente de réparer les produits, de manière autonome, sans autorisation ni contrôle du Vendeur.
9. Juridiction et loi applicable
- 91 Tout litige concernant le présent contrat qui ne serait pas expressément ou implicitement réglé par les présentes conditions générales ou par d'éventuelles conditions spécifiques convenues entre les contractants est régi par la Convention des Nations Unies sur la vente internationale des marchandises (Convention de Vienne de 1980) et les litiges non couverts par cette convention seront réglés par la loi italienne.
- 92 Toute controverse découlant du présent contrat, relative à ce dernier ou concernant les produits sera portée exclusivement devant le tribunal de Padoue. Cependant, par dérogation à cette prescription, le Vendeur a toujours la possibilité de porter la controverse devant le Juge compétent là où est domicilié l'Acheteur.
10. Clauses finales

L'éventuelle invalidité partielle ou totale de l'une des clauses des présentes conditions générales de vente n'entraîne pas l'invalidité, respectivement, de la totalité de la clause ou de ces mêmes conditions générales de vente.

CONDITIONS DE VENTE

TVA	exclue, dans tous les cas, conformément à la loi
IMBALLAGE	Carton renforcé (inclus)
	Caisse/cage (sur demande - avec supplément)
PORT	FCA-FREE CARRIER, BORGORICCO (PD) ITALY INCOTERM ®2010
LIVRAISON	À fixer à la commande
PAIEMENT	Selon accords
CONDITIONS GÉNÉRALES	Comme indiqué au verso de la facture



Le tonalità di colore sono puramente indicative e potrebbero non corrispondere al colore reale del mobile.

Enofrigo SpA si riserva di apportare ai propri prodotti qualsiasi modifica ritenuta utile al miglioramento qualitativo degli stessi, sia dimensionale che strutturale.

Le riproduzioni di questo catalogo possono non corrispondere alle versioni commercializzate perché soggette alle norme in vigore in ciascun paese di destinazione. ENOFRIGO S.p.A. si riserva di apportare modifiche alla costruzione ed alla dotazione dei mobili senza alcun obbligo di preavviso.

Colour tones are just samples and may not correspond to the real tone of the unit. Enofrigo SpA reserves the right to modify the dimensions and structure of its products at any time without prior notice in order to improve quality and durability.

Any reproduction of this catalogue may not correspond exactly to the commercialised versions since they are subject to laws and regulations in force in different countries. ENOFRIGO S.p.A. claims the right to introduce changes in manufacturing process and units equipment without prior notice.

Les nuances de couleur sont purement indicatives et pourraient ne pas correspondre au réel coloris du meuble. Enofrigo SpA se réserve d'apporter à ses produits toute modification jugée utile visant à améliorer leur qualité, que ce soit en matière de dimensions ou de structure.

Les reproductions de ce catalogue peuvent ne pas correspondre aux versions commercialisées car soumises aux normes en vigueur dans chacun des pays de destination. ENOFRIGO S.p.A. se réserve d'apporter des modifications à la fabrication et à l'équipement des meubles sans aucune obligation de préavis.



ENOFRIGO S.p.A.
I - 35010 Borgoricco (PD)
Via dell'Industria, 9/a
Tel. +39 049 5798041
Fax +39 049 5798806
info@enofrigo.it
www.enofrigo.it

INFORMAZIONI COMMERCIALI
SALES INFORMATION
vendite@enofrigo.it
Tel. +39 049 5798041

www.enofrigo.it

